

# ACER

*Technology • Creativity • Reliability*  
*An Unswerving Commitment to Excellence*

# ACER

[www.acerlinks.com](http://www.acerlinks.com) / [www.aceronline.net](http://www.aceronline.net) (U.S. Only)

**KLIM INDUSTRIAL, INC.**

244 N. Randolphville Rd.  
Piscataway, NJ 08854  
Tel: (732) 752-9100  
Fax: (732) 752-9101  
E-mail: [acer\\_klim@yahoo.com](mailto:acer_klim@yahoo.com)

**YA-GIN MACHINE TOOL MANUFACTURING, INC.**

No. 101, 506 Lane, Seng-Tso Road  
Seng Karng District, Taichung City, Taiwan  
Tel: 886-4-2520-4120  
Fax: 886-4-2520-4123  
E-mail: [sales@acerlinks.com](mailto:sales@acerlinks.com)



## **ACER BED-TYPE CNC MILLING MACHINE**

**The Simplistic "Need" for A Modernized Toolroom!**

ACER Bed-Type Milling Machines

The ACER bed mill series is comprised of the most complete metal cutting machines for today's toolroom applications. Built to be the most accurate and reliable machines of their category, ACER bed mills are also extremely easy to use. Equipped with a manual pulse generator and X & Y axis handwheels (on certain models), ACER bed mills give users the flexibility and versatility to work in manual, semi-CNC, or full CNC mode. The various brands of conversational CNC controllers make programming easy so even one prototype part can be completed effortlessly and efficiently.

## ACER Bed-Type CNC Milling Machine

Shown with  
Options



**ATM 1054II**



**Bed-Mill 1454II**



**Bed-Mill 1454II w/Fanuc CNC Controller**



**Bed-Mill 1054II**



**Bed-Mill 1454**

Shown with  
Options



**ATM 1454II**



**Bed-Mill 1054**



1 A great form casting comes from a precision crafted mold. For its outer appearance, ACER iron castings are vividly recognized from the molds and at the machining sections, they are precisely casted within 5mm of finished dimension. This enables a fast, clear and precision machining done within a specified time.



3 All annealed ACER FC-30 iron castings are stockpiled and aged prior to machining. This is done to eliminate future molecular realignment and deformation on the castings.



5 The Z-axis and all guideline surfaces, including the dove-tail ways on the table, are induction hardened to reach HRC 52 degrees.



2 The exceptionally high-stiffness "MEEHANITE" casting undergoes an annealing process to eliminate internal stress prior to machining.



4 The final foundation of accuracy (squareness, flatness, and parallelism) is milled and machined exclusively on a five-face machining center. The accuracy is guaranteed to be within 0.0004" of each overall travel axis.



6 With a special fixture on a horizontal boring machine, the spindle housing is machined and honed to within 0.0002" per 12", and its parallelism to the guideway is within 0.0004" per 12".



7 Specially designed bridge-type planer mills are used to machine ACER working tables and columns. The parallelism of the slideways to each other and the T-slots to the guideway are guaranteed to be within 0.0008" of each other.



9 Precision grinding on dovetail-ways and the table bottom ensures a longitudinal guideline accuracy of 0.0004" over 50".



11 The base of the machine is the foundation of a machine's accuracy. The slideways on the base of ACER bed mills are hardened and ground to within 0.0004" over the entire travel length.



8 All contacting slideways on ACER saddles are laminated with Turcite-B. They are precision milled to maximize contact surfaces and allowing for time reducing hand-scraping procedure.



10 Using the precision ground dovetail-ways as the guideline, the table top is ground within 0.0005" over 50".



12 Before the saddle is loaded onto the machine base, the guideways of the saddle are fit to a table. The laminated gibs are then scraped on both sides to fit between the two components. This procedure on these mechanisms ensures and produces a lateral movement of less than 0.0004" per 40".



13

The automotive painting process is the foundation of the appearance of an ACER machine. All ACER castings are padded with a metal-like bonding and sanded to reach the best contours. They are then spayed with automotive epoxy to achieve the final look.



15

The final step in the ball screw installation process is checking the axial pulling value. The total number shall not be less than 0.0016". This is needed if repeatability and positioning accuracy are required.



17

The spindle is carefully installed onto the spindle housing. ACER technicians will make sure the spindle is parallel to the Z axis slideway (within 0.0004" per 12"). When this is achieved, the bottom of the spindle face will be perpendicular to the table top.



14

Before the ball screws are installed onto each axis, technicians use modular tools to align the bearing brackets. The standard alignment accuracy is 0.0004" per 40". This procedure will ensure smooth ball screw movement and an extension of the ball screw lifespan.

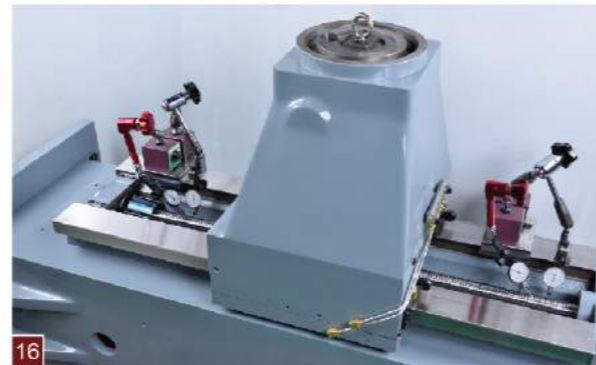

16

Once axial numbers are recorded, a final alignment check on the ball screw is executed. A number of 0.0002" maximum radial deviations are allowed within the front and the end of the ball screw.



18

After scraping the saddle to the machine base, the column is then scraped on the bottom and loaded onto the base seat. To ensure the perpendicularity and parallelism of the column to the table top, a 90° granite angle plate is used to check and re-check the moving values' accuracy. This procedure continues until ACER's standards are met.



19

The automatic tool changers (ATC) are checked carefully. ACER technicians will not install an ATC if it does not pass ACER's strict standards.



20

The umbrella type ATC has an easy procedure for spindle alignment. Once the umbrella ATC is installed, a technician will adjust and center the tool position with an alignment bar and its connection plate. When it is perfectly centered to the spindle, the alignment bar will move up and down freely which will allow for a smooth moving tool change. This alignment procedure will reduce wear on the spindle taper and prevent pressure build up in the spindle bearings.



21

All optional sheet metal components and optional accessories are installed when the machine is ready for shipment. ACER technicians will match the optional sheet metal parts and make sure they are secured tightly before packaging.

Shown with Options

- Optional Accessories:
1. Rear Splash Guard Set
  2. Chip Pan
  3. Table Guard with Door
  4. Remote Manual Pulse Generator (M.P.G)
  5. Halogen Work Light



1 The ball screw is the heart of all ACER bed mills. They are precision ground to a C5 specification, laser calibrated and then measured for accuracy in a temperature-controlled room at 70°F.

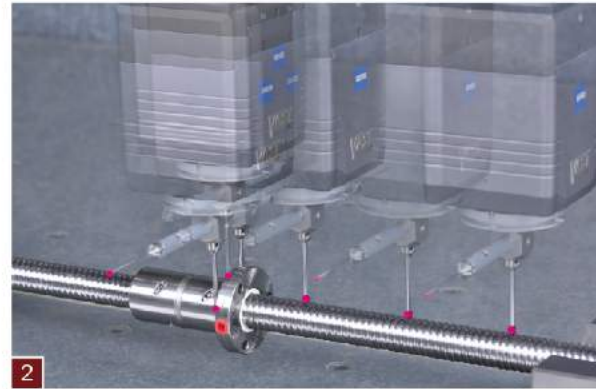

2 From batch to batch, ACER will inspect the ball screw with CMM machines. ACER will make sure that a 90° angle exists between the linear ball screw and the ball crew nut's flange face. This is done to ensure smooth movement when the ball screw is installed onto the machine's yoke or the screw's bearing brackets.

Inspected By Agilent Laser Measuring System  
All Measurement According To JIS B 1192 : 1997

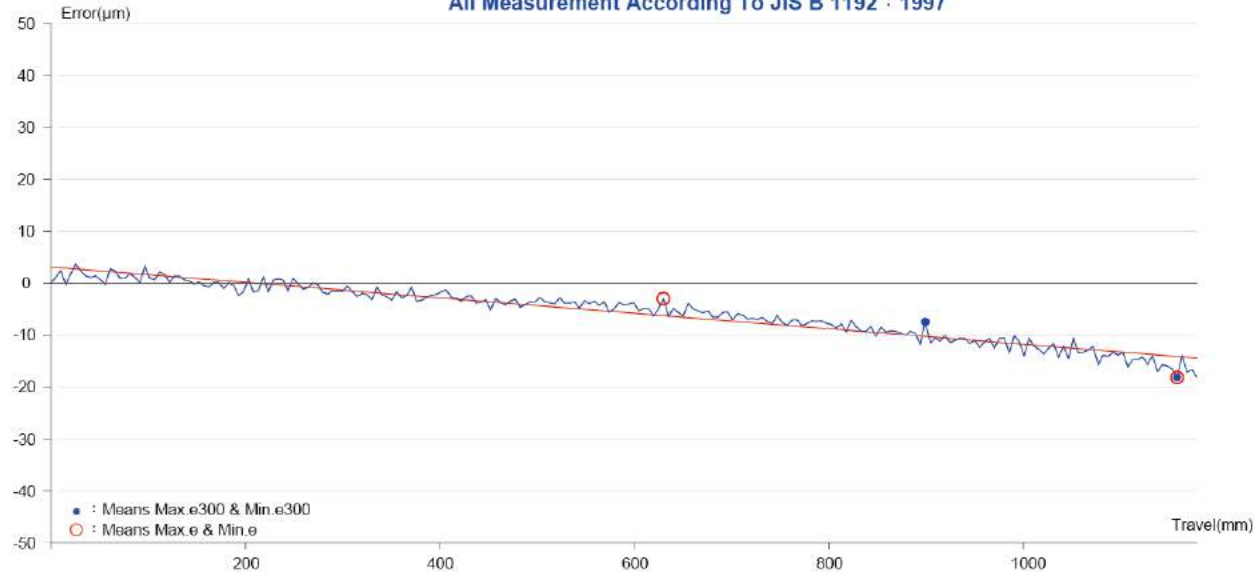

| Specifications :                                    | Measuring Result : | Permissible Error | Actual Measuring Error | Measuring Environment :                 |
|---|--------------------|-------------------|------------------------|---|
| Customer : 亞 欵                                      | T+E (µm)           | -79~13            | -17.58                 | Reference Temperature : 20°C ± 1.0°C    |
| Order No. : S1-160052551012                         | e (µm)             | 30                | 7.31                   | Relative Humidity : 50% ± 10%           |
| Drawing No. : BA105400016-2                         | e300 (µm)          | 18                | 6.07                   | Measuring Device :                      |
| Part No. : B1-A034-X-1                              | Tq(kgf - cm)       | 1.25~2.5          | 1.25~1.756             | Air Bearing guided Measuring Machine    |
| Specification : R25-5.0BT4-FDIC-1216.6-1596.6-0.018 | Accuracy Grade     | C5                | C2                     | Agilent Laser Interferometer Type 5527A |
| Nominal Diameter (mm) : 25                          |                    |                   |                        | Inspector : David                       |
| Nominal Pitch (mm) : 5.08                           |                    |                   |                        | QC 2016/12/03                           |
| Travel Length (mm) : 1178                           |                    |                   |                        | PASS                                    |
| E(µm) : +48   |                    |                   |                        | F-B410-01-08-A                          |
| T(µm) : -33   |                    |                   |                        |   |

3 This inspection report is a sample of ACER ball screw's measurements. If reviewed carefully, the accuracy of ACER ball screws come in the C3 standard. With this type of ball screw's accuracy, ACER bed mills are able to meet the strict requirements and standards of DIN or JIS.



4 Results from the CMM machine on the roundness and linearity of the ball screw will be compared to the digital inspection sheet. ACER does this to reduce installation trouble. A definite good component will allow technicians to troubleshoot faster if some variations are eliminated beforehand.



5 Before the ball screw brackets are installed, every pair of the angular motor on the ACER bed mill. Both contact ball bearings is checked for its thickness. The depth of the bearing bracket is also measured. After vibration and excess nose during the procedure, the ball bearing pair is installed into the bracket with a preload value of 0.0008". This will ensure a sturdy hold on the ball screw when the axis is moving.



6 There are two styles of the spindle motor on the ACER bed mill. Both angular motor and pulley are dynamically balanced individually to eliminate vibration and excess nose during operation.



7 Perpendicularity, flatness, and parallelism are the foundation of the radial and axial movement of the slide-ways. For example, on the column, ACER will measure the aforementioned three criteria with a CMM machine. A less than 0.0004" deviation for each criterion on the entire traveling surface is required when grinding is done on the slide-ways. If this threshold is not achieved, ACER will re-grind the guideline surface until the number is achieved.



8 Table inspection is also a pre-installation requirement. With aid from engineering levels and a CMM machine, ACER is able to grind the table flatness within 0.0004" per 50° and the slideway guideline to be within 0.005" over 54°.



The spindle is the heart of any machine. In particular, ACER spindles must go through a three-stage testing and inspection. Once a spindle is assembled, it must be checked for spindle taper and axial run-out. 8µm is the maximum radial run-out and 2µm is the maximum axial run-out.

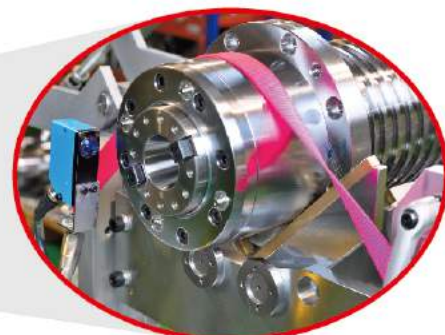

Next, the spindle will go to the balancing and noise gathering stage. After adding another piece of the spindle's component, a pulley then runs the two together through a dynamic balancing machine in order to collect the spindle's noise intensity. A balance degree of less than 1mm/sec and a noise level of less and 80dBs are the ACER machine standard. If these numbers are not met, the spindle will not be used and will be returned to the start of the spindle's assembly line.



Temperature rise is always an issue with a spindle. The ACER spindle's final stage testing is running the spindle over 48 hours to see if the temperature deviation is within the ACER standard. On the spindle, ACER will attach two sensors onto the spindle quill. One is at the front end of the spindle which is close to the tool holding end. The other is located at the back side of the spindle which is close to the pulley end. These two sensors will simultaneously feed data into the computer to compile a graph chart. Less than a Δ20° rise from room temperature is needed in order for an ACER technician to accept the spindle.

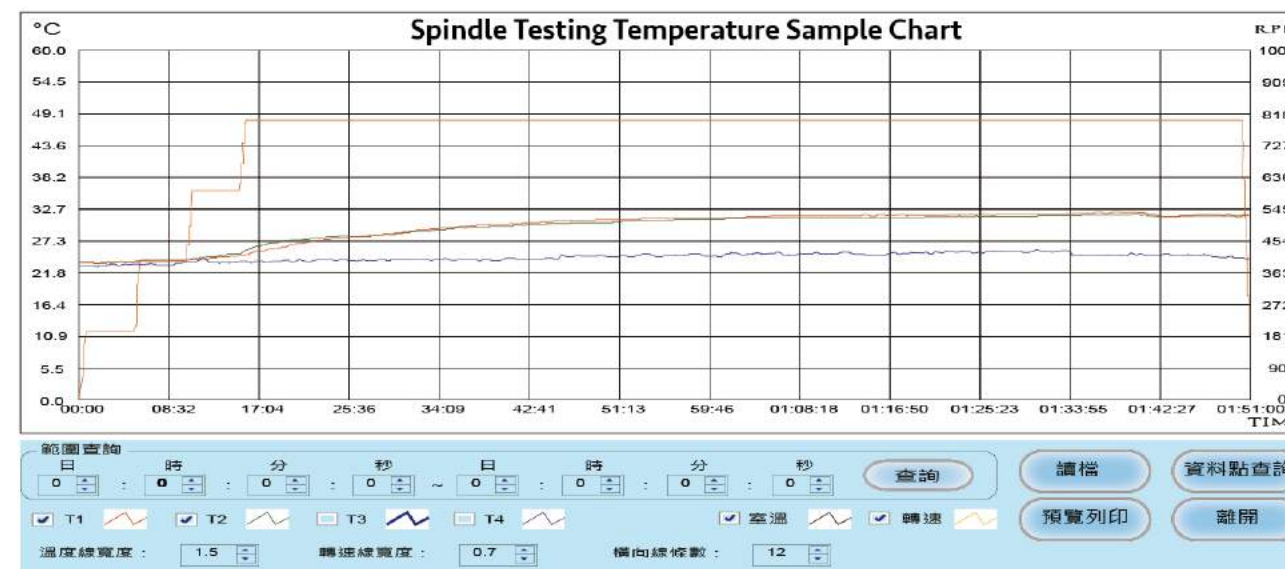

11

### SPINDLE PRECISION TEST REPORT

|   |  |   |
|---|--|---|
| Customer : ACER                                       | Date : 2018/3/1  |   |
| Model : KL1212  | Serial : NO. KN8917  |   |
| Speed   | 16000 RPM  |   |
| Housing Size  | Ø 120 mm   |   |
| Drive   | <input checked="" type="checkbox"/> Belt <input type="checkbox"/> Direct <input type="checkbox"/> Gear <input type="checkbox"/> Built-in                   |   |
| Pully (Gear)  | <input checked="" type="checkbox"/> Timing Belt <input type="checkbox"/> V-Type <input type="checkbox"/> Gear  |   |
| Taper   | <input type="checkbox"/> BT <input checked="" type="checkbox"/> BBT <input type="checkbox"/> DIN <input type="checkbox"/> CAT <input type="checkbox"/> HSK |   |
| Gripper   | <input type="checkbox"/> BT <input type="checkbox"/> DIN <input checked="" type="checkbox"/> CAT   |   |
| Air Flow  | <input checked="" type="checkbox"/> YES <input type="checkbox"/> NO  |   |
| Cooling Through Spindle                               | <input checked="" type="checkbox"/> NO <input type="checkbox"/> YES  |   |
| Working Position                                      | <input type="checkbox"/> Horizontal <input checked="" type="checkbox"/> Vertical   |   |
| Lubrication   | <input checked="" type="checkbox"/> Grease <input type="checkbox"/> Air-Oil  |   |
| Item  | Standard Value   | Measuring Value                           |
| Balance Degree  | 1 (≤1mm/s)   | 0.4 mm/s                                  |
| Temperature Test (Room Temp. : 25°C)                  | Temperature Rise ≤ 45 °C   | Front Temp. : 40 °C<br>Rear Temp. : 38 °C |
| Shaft Surface Runout                                  | ≤ 2 µm (BBT/HSK)   | 1 µm                                      |
| Test Bar Front  | ≤ 2 µm   | 2 µm                                      |
| Test Bar In 200mm <input type="checkbox"/>            | ≤ 8 µm   | 6 µm                                      |
| Test Bar In 300mm <input checked="" type="checkbox"/> | ≤ 8 µm   | 6 µm                                      |
| Pulling Force   | 7 KN ±10%  | 7 KN                                      |
| Gripper ejection Path                                 |  | mm  |
| Remark  |  |   |

Approbation : 張政偉

Inspector : 游宗瑞

12

A sample of test report displays what ACER has inspected and tested before letting the spindle proceed to the ACER assembly line.

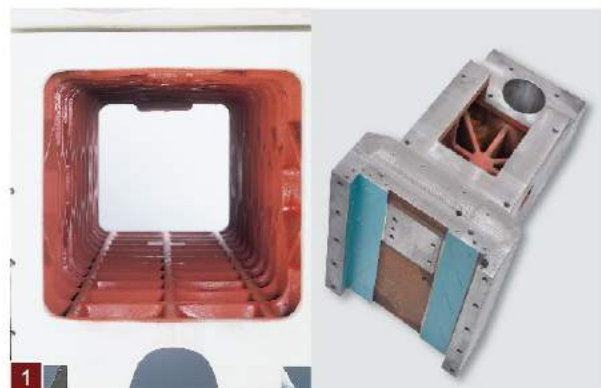

The foundation of a machine is within its castings. The components on an ACER bed mill are casted from FC-30 graded iron. The column and the spindle housing must be rigidly casted to withstand heavy-cutting. The spindle housing is casted with deep triangle web ribs. This style of ribbing will distribute and deflect all cutting force toward the column. This minimizes the upward movement on the spindle housing. The column has hexagonal-type web ribs with three vertical supporting ribs to counteract the force transfer from the spindle housing. With this design, the column will distribute all cutting force in order to withstand any heavy duty cutting.



The design principle of the 1054 series castings is square, with a box way rib design that connects the round spindle housing to the back end of the slideway. This design will absorb and distribute the cutting force toward the column. This FC-30 casted housing can withstand heavy cutting.



To support a work piece around 1,980 lbs, the table and saddle of the machine must have proper rib support. ACER tables are casted with 12 arch style ribs and two longitudinal ribs running throughout the entire table length. This structure design helps to maintain table top accuracy when a heavy weight is loaded. Triangular ribs combined with horizontal running ribs on the saddle typifies the ACER design concept. As more weight or force is exerted any component, ACER component will distribute this entity toward all supporting components. This design concept will minimize distortion on individual components and assist in maintaining overall machine accuracy.

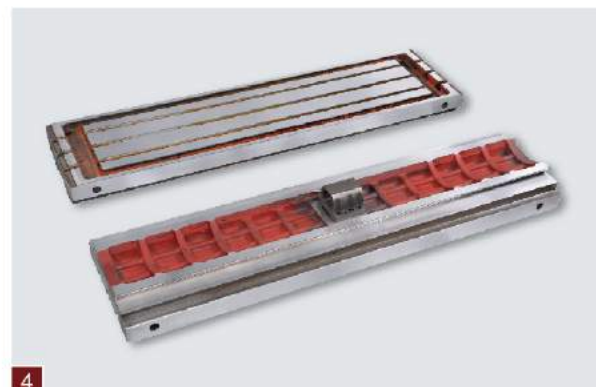

Acer tables are casted with 12 arch style ribs and two longitudinal ribs running through the entire table length. This structure design helps to maintain table top accuracy under stress. No deformation or twisting will occur when a heavy weight is loaded onto the table. This means that when a heavy work piece is loaded, the table will still move with ease.



An inverted T column is a special feature of ACER bed mills. The bed mill columns also have a square or hexagonal type rib. With deep top-down running and horizontal ribs, ACER columns are very rigid and study. The base of the inverted T column is incorporated with circular ribs joining the "I" section. Thus, all weight on the "I" section is fully distributed onto the machine base. This means that no rocking on the column will occur when heavy cutting is taking place.



Every ACER bed mill spindle is loaded with four P4 precision angular contact ball bearings (NSK or FAG). This front-end pairing design will allow for heavy cutting when machining. The spindle shaft and spacers are precision ground to an accuracy of 0.0001" in roundness and 0.00004" in parallelism. Technicians are then able to assemble and control the spindle run-out and its preloaded value to ACER specifications.



The floating tool change device will reduce pressure and wear on the spindle. With the super 8YU timing belt (on the 7.5HP model only), all cutting torque is transferred to the cutting tool which makes cutting through a work piece a breeze.

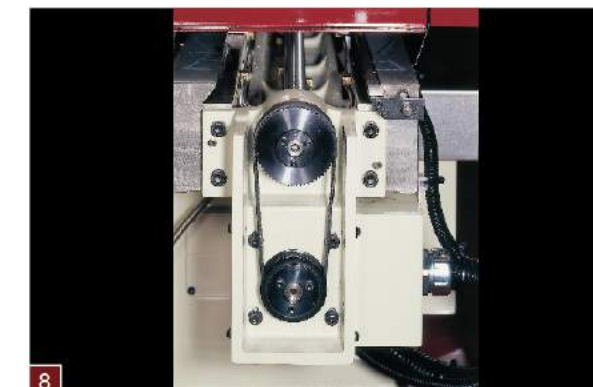

The axis servo motor is joined with a C5 ball screw through a non-slip HTD timing belt. With proper tension on the belt, 100% of the motor torques is transferred to the ball screw. Thus, the ACER bed mill is able to cut through a heavy work piece at a higher feeding rate.



The ACER CE standard electric cabinet is carefully laid out and ready for more expansion. When users need to add a fourth axis or trouble shoot the circuitry, this cabinet allows for easy access and simple diagnoses.



The automatic lubrication system comes standard on all ACER bed mills. This three-liter unit can force, time, and adjust lube oil to all necessary parts. When oil level is low, a buzzer will sound and the controller will halt the running program. The program will then restart when the reservoir is filled.

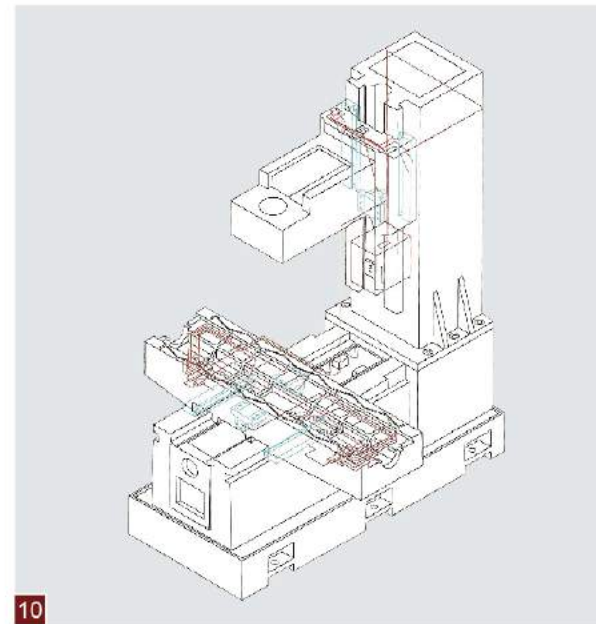

On ACER's centralized lubrication system, all outputs have check and metering valves to ensure proper lubrication (dictated by green points on the drawing). The function of the check valves is to verify once the oil reaches the specified area, it will not back flow. The function of the metering valves is to control the amount of oil going to each position. With both items, all ACER bed mills are properly lubricated and oiled. (Model 1454 is shown on the drawing).



Scraping is the soul of a machine's accuracy. All three axes must be scraped and aligned with different measuring gauges in order to conform to ACER specifications. With countless high and low points on the Turcite-B way, lubrication oil is easy retained which will help to reduce wear and friction when the axes are moving. A sample lubrication system on the saddle shows a systematic alignment of the aluminum tubing and its fittings. All three axes on the ACER bed mills will have the same scheme and workmanship.



### USER-FRIENDLY SAVE VALUABLE TIME.

The MILLPWR G2 is a contouring control that enables you to program conventional machining operations right at the machine in an easy-to-use conversational language. It is designed for both knee mills and bed mills with up to 3 axes of closed loop controlled.

MILLPWRG2 was developed specifically for machinists where manual and automated operation are both useful and needed. It's designed to maximize throughput by significantly reducing set-up time, scrap, and other non-productive operations, thereby increasing your efficiency, productivity and profitability.

A closed-looped system with positioning feedback provided by ACU-RITE precision linear encoders (1µm/0.00005" resolution), MILLPWRG2 also includes Position-Trac™, an advanced, unique feature that enables you to easily, quickly and accurately re-establish work piece zero after shutting down or power loss.

|  |   |   |   |
|--|---|---|---|
| <b>TOOL</b><br>Program tools by diameter, length, type, direction, speed | <b>RECT</b><br>Pocket, frame, face, slot                      | <b>CIRCLE</b><br>Pocket, frame, ring, helix                                     | <b>HOLES</b><br>Full/ partial circles, linear row/column, rectangular frame and array |
| <b>POS</b><br>Drill, bore, position                                      | <b>LINE</b><br>Defined by "from" and "to" points or by angles | <b>ARC</b><br>Defined by "from" and "to" points or by sweep, center or 3-points | <b>BLEND</b><br>Insert a corner radius between two lines, two arcs or lines and arcs  |



ACU-RITE offers a complete line of digital readouts and precision linear encoders.

| DRO Mode                         |     |
|----------------------------------|-----|
| Multiple Datums (Fixture Offset) | 99  |
| Skew                             | Yes |
| Zero Reset                       | Yes |
| Near Zero Warning                | Yes |

| PGM Mode                             |   |
|--------------------------------------|---|
| Estimated Machining Time             | Yes   |
| View Graphics                        | 2D Line / 3D Line / 3D Solid                  |
| Block Form                           | Yes, w/ User Override                         |
| Custom Pocket & Islands              | Yes, Ramp Feed & Optimized Path               |
| Replication (Repeat, Rotate, Mirror) | Yes   |
| Engrave (Line / Arc)                 | Yes   |
| Program Manager Navigation           | Tree w/ Program Type Filter                   |
| Long Program Names                   | Yes   |
| Program Preview                      | Listing & Graphic w/ Estimated Machining Time |
| Explode Step                         | Hole Patterns & Repeat / Rotate / Mirror      |
| Reverse (Step / Path)                | Yes   |
| Shift Steps                          | Yes   |
| Auto Save (Program)                  | Yes   |
| Program Size Limit (MPT only)        | 9999 Steps                                    |
| DXF File Import                      | Yes   |
| G-code Program                       | Yes, w/ Graphics Support/Simple Edit          |
| On-Screen Help                       | User Manual Viewer (Text & Graphics)          |
| Parts Counter & Clock                | Yes   |
| Manual / Auto Z Control              | Yes, 3 Axes                                   |
| Optional Stop (G-code Only)          | Yes   |
| Feed Override                        | Potentiometer                                 |
| Error Compensation                   | Linear & Bidirectional Non-linear             |

| Hardware                   |   |
|----------------------------|---|
| Processor                  | 1.4 GHz Dual Core Celeron ® Processor     |
| Display                    | 12.1" 1024 x 768 Color TFT LCD            |
| Internal Storage           | 2.5 GB CFAST (SATA) User                  |
| Remote Pendant (Stop / Go) | Yes                                       |
| Housing                    | Die Cast Metal (Bezel & Back Sheet Metal) |
| Connections                | Ethernet, USB (x2)                        |
| Protection                 | IP 54 (front) / IP 40 (Back)              |

- TOOL LIBRARY**  
Create a list of frequently used tools to save time while programming a part.
- TOOL OFFSETS**  
Automatically compensate for the tool's dimensions while machining.
- CUSTOM POCKET/ISLANDS**  
Clear an irregular contour with multiple passes and finish passes.
- TOOL PATH ESTIMATION**  
To help reduce machine time and assist with quotes. Easily manipulate part programs to save time and reduce program steps.
- EXPLODE**  
Explode a program step into several, more detailed steps for easier editing.
- REVERSE STEP/REVERSE PATH**  
Switch the end points and tool offset of any step or path.
- CHANGE STEPS**  
Change or edit the depth, offset, feed rate of several steps simultaneously.
- TRAVEL LIMITS**  
Establish maximum travel limits with software, instead of costly mechanical switches that reduce travel.
- FEED RATE OVERRIDE**  
Adjust the feed rate without exiting the milling function or program. Spindle speed override in optional spindle control console.
- REFERENCE TABLES**  
Look up recommended surface speeds in seconds.
- REMOTE STOP/GO**  
Start and pause movement with a hand held switch.
- JOG CONTROL**  
Move quickly from one location to another utilizing one or all axes simultaneously.

| Options   |  |
|---|--|
| <b>UPGRADE</b><br>Upgrading from an old MILL-PWR11 to MILL-PWRG2 only requires the new G2 console and mounting arm. | <b>OFFLINE SOFTWARE</b><br>This allows you to create programs on a Windows compatible PC and permits those programs to be loaded into the MILLPWRG2 via USB or ethernet. |





### Fagor CNC 8055i MC ICON-based Conversational CNC

The Fagor 8055i FL MC CNC control combines value & reliability with a featured packed compact control. This control was built for the shop environment with a rugged keyboard and single enclosed design. The unique and very powerful operating system consists of 2 systems within 1 control. Utilizing a 100% easy to program Icon Key based conversational programming system or a Conventional ISO G-code programming system within the same control. You may toggle between the two operating systems at any time by simply pressing shift-esc. There are many benefits to this, one is the ability of the control to adapt to the operator/programmers ability, another very valuable benefit is you now have a Machine that is perfect for quick set-up small lot production and also ideal for complex large production run parts. The Fagor "Icon Key" programming method greatly simplifies the programming process even compared to more conventional conversational systems due to the one screen, one operation philosophy that simplifies the programming process by keeping all cycle information necessary on a single page. No prior programming experience is necessary.

- 4 axis CNC + spindle capability
- USB port for easy program uploading
- Remote Online Assistance (option)
- DXF file conversion capability (DNC)
- 3 simultaneous graphic views
- Solid 3D Graphics with part rotate and zoom.
- Machining canned cycles
- Rectangular Boss cycle, Round Boss cycle, Rectangular Pocket cycle, Circular Pocket cycles, Profile Pocked 2D & 3D cycles, Slot Milling, Profile Milling, Multiple Drilling cycles, Boring cycles, Reaming cycles, Arc bolt hole cycles, Random position cycles, Grid Pattern position cycles.
- Part Scaling (in part or whole)
- Part execution time estimation
- 10.4" High Resolution LCD color monitor
- Direct Blue Print programming with CNC language (ISO), and the Interactive Editor & Icon key driven conversational editor.
- HRSR232 serial port
- DNC capability
- WinDNC offline software program (free)
- Advanced block look ahead
- Jerk control
- Feed Forward
- Linear, Circular and Helical Interpolation
- Tool Radius & Length compensation
- Execution mode
- Simulation dry run mode
- Jog Mode
- MDI Mode
- Teach-in / Play-back programming mode
- Background editing
- Parameter mgmt Mode
- Tool offset and Zero offset tables
- Arc tangent to previous path
- Mirror Imaging
- Tangential entry and exit
- Automatic chamfer blending
- Arc defined by three points
- Automatic radius blending
- Programming in absolute arc center coordinates
- Definition of lower work arealimits
- Zero offsets and auto deletion of offsets
- Probing cycles (option)
- Digitizing cycles (option)
- Automatic machine home sequence
- Preset of coordinate values & polar origin
- High Level programming language
- Parametric programming for advanced math and trig function in part program
- Automatic tool calibration mode
- Tool inspection mode with auto - return
- Mid program start
- Programmable spindle speed
- 15 nesting levels
- Repeat of sections of program
- Zero offsets
- Feedrate: 0.00001 to 7900 inches/min.
- On board graphic editor
- Override control for feedrate and spind
- Assisted help mode for all programming commands
- Host of standard used M-codes and user defined
- Display of execution time
- Display of parts counter
- Position and following + error (axis lag)
- Comments included in - the part program 10 languages loaded.
- Host of on-board self diagnostic tools
- Lead screw and backlash compensation
- High Speed integrated PLC
- On board PLC I/O Logic Analyzer

### Fagor Intelligent Profile Editor (On-board mini CAD/CAM System)

Blueprints do not always show the starting and ending points of each section or shape. Sometimes it suffices to just indicate the inclination angle of a section and other times it is enough to indicate that it is a tangent to the previous section. With the Fagor Intelligent Profile Editor no calculations are required, simply enter the known data into the CNC and the CNC automatically calculates the Solution. When there is more than solution, all possible solutions are shown graphically so that you may choose the correct one.

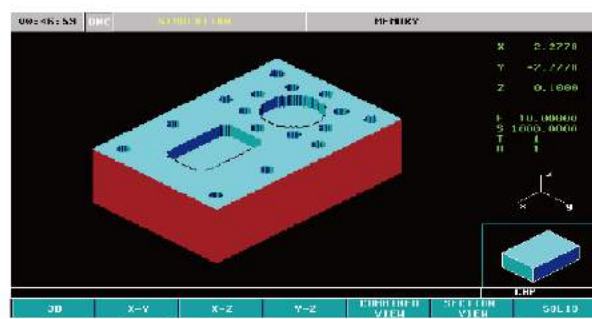

(Solid Graphics display)



### Series 0i-MODEL F:

The FANUC Series 0i-MODEL F is the newest generation in the highly popular Series 0i and integrates many features found on the Series 30i-MODEL B. The Series 0i-F brings faster, more accurate performance to a wide range of milling applications with more standard features, more advanced capabilities and faster communications than ever before. The Series 0i control is the industry's most reliable system with a Mean Time Between Failure rate of 52 years.

### The Series 0i-MODEL F offers:

#### Seamless Functions with 30i-B series CNC

- Common screen and operability
- Common maintenance
- Common network functions
- Use of common peripheral devices
- Support of the same PMC functions

#### Minimizing Downtime

#### Focusing on Minimizing Downtime High Reliability and Easy Maintenance

- Highly reliable hardware allows stable operation in a harsh factory environment
- Failure prediction functions such as the leakage detection function achieve preventive maintenance, preventing long machine downtime
- Enhanced diagnosis and maintenance functions make it easy to identify failure locations and reduces time for recovery
- Improved maintainability achieved by the structure that allows for quick replacement of fans or batteries

### 0i-MF Package-5 includes the following Basic Functions:

- Increment system 0.001mm, 0.001deg, 0.0001inch
- Inch/metric conversion
- Sequence number comparison and stop
- Program restart
- Single block
- Manual handle feed x1, x10, x100
- Helical interpolation
- High-speed skip - for probing
- Automatic acceleration/deceleration
- Smart overlap
- Feedrate override
- AI advanced preview control
- Bell-type acceleration/deceleration
- Polar coordinate command
- Workpiece coordinate system G52 ~ G59 (48 sets)
- Workpiece coordinate system preset (G92 Reset)
- Programmable data input G10
- Alarm history display
- Operation history display
- Run hour and parts count display
- Servo waveform display
- Multi-language display - including English, Spanish, Chinese (Traditional Chinese), Chinese (Simplified Chinese) and Portuguese....
- Tool Path Graphic display
- Power consumption monitoring
- Screen hard copy
- Automatic data backup
- PMC Ladder display
- Self-diagnosis function

### FANUC Machine Operators Panel:

- E/Stop
- Spindle Override - rotary select switch
- Feedrate Override - rotary select switch
- Mode selection - AUTO, EDIT, MDI, REMOTE, REF, JOG
- Spindle Direction CW CCW and Stop
- Cycle Start and Stop
- Axis Jogging/Rapid
- Single Block, Block Skip, Optional Stop, Restart, Machine lock and Dry Run selection

### FANUC Pendant style Handwheel:

- Axis selection - X Y Z 4th
- Pulse increment selection - x1, x10, x100



1 Flatness of the table is test on two directions. Both Z to X plane, and Y to X plane engineering levels should come within 0.0012" per 40".



2 Axial run-out of the spindle is measured and recorded. Less than 0.0002" is the permissible value.

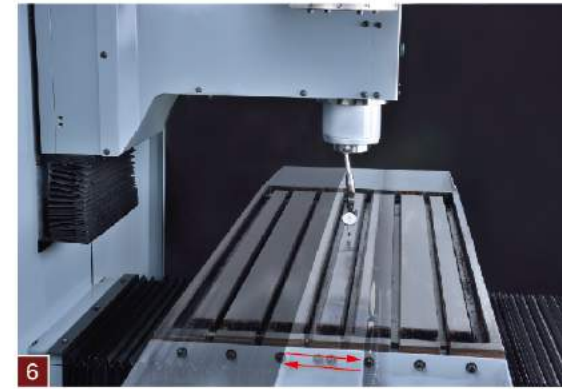

6 Parallelism of the table movement in Y axis is measured with a dial indicator. The accepted value is less than 0.0004" per 20".

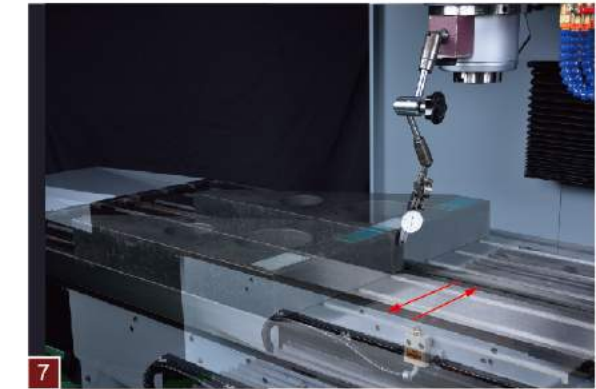

7 Squareness of the X axis movement is indicated on a granite angle plate. After indicated in longitudinal direction on the angle plate, traveling the Y axis will show the perpendicularity of the motion. A recorded value less than 0.0004" per 12" is required to pass this inspection.

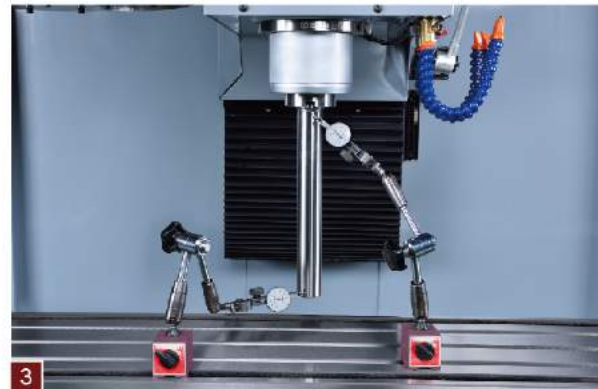

3 Run-out of spindle taper is quantified at two different positions. One is at around spindle nose. And the other one at 12" from the spindle nose, the measurement of the value must be within 0.0004" to pass ACER standard.

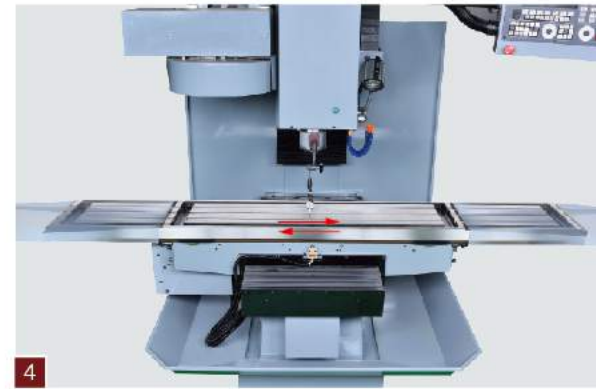

4 Parallelism of the table movement in X axis is dial in with a dial indicator. The permissible value is 0.0004" per 20".



8 Squareness of the head movement to the table is measured at two viewpoints. Measurement of Z to X plane and Z to Y plane has an allowable number of 0.0004" per 12".

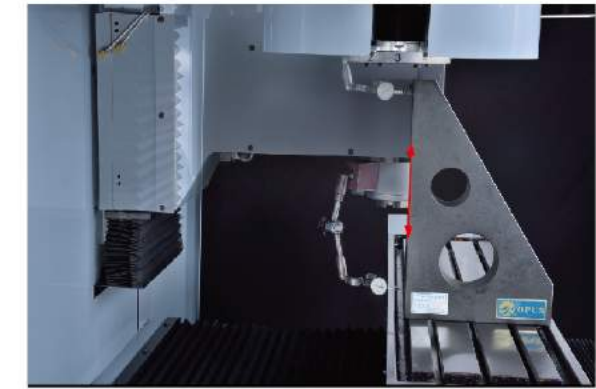

9 Squareness of the spindle to the table top also has two dimensions. Measuring Z to X plane and Z to Y plane with a dial indicator, their measured value must be within 0.0004" at a 6" radius.

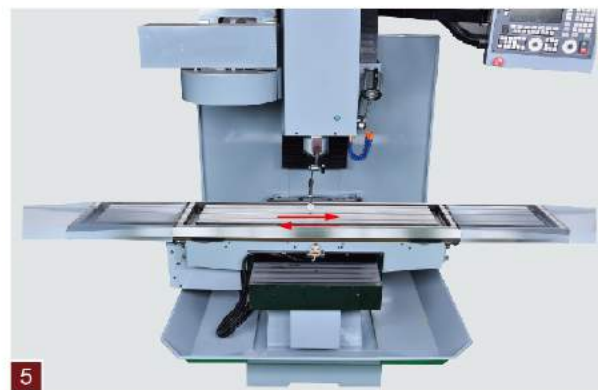

5 Parallelism of the T slot and X axis movement is also an inspection value. Normally per 40" the tolerated maximum number is 0.0008".

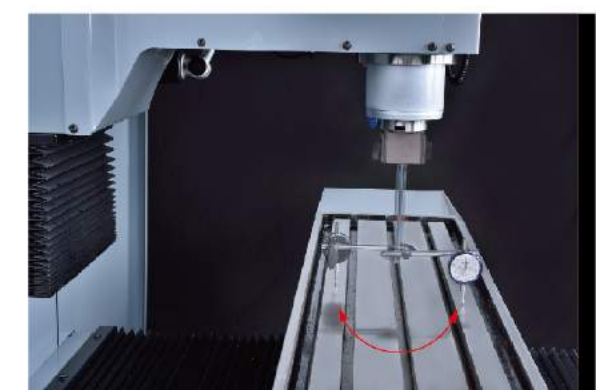



1 Angle Lock Milling Vise



2 52pcs Clamping Kit



3 Manual Horizontal/Vertical Rotary Table



13 Column Side Guard and Chip Pan



14 Chip Pan



15 Table Guard



4 T-Slot Cover



5 Telescopic Stainless Cover



6 Spindle Guard

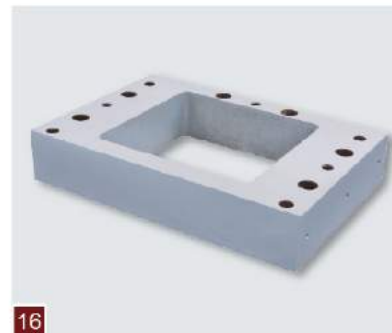

16 Riser Block for 1454 Model



17 4th Axis Rotary Table



18 Tailstock



7 Hydraulic Machine Vise



8 Air Power Drawbar



9 CAT or BT#40 Tool Holder Set



18 Table Top Guard



19 Halogen or LED light

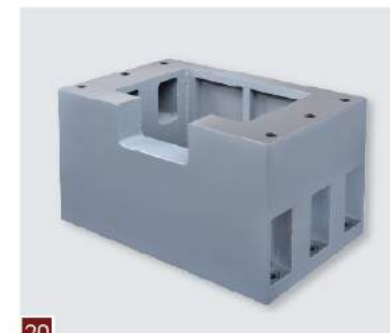

20 Riser Block for 1054 Model



10 Coolant System



11 Semi-Universal Dividing Head



12 CNC Power Vise

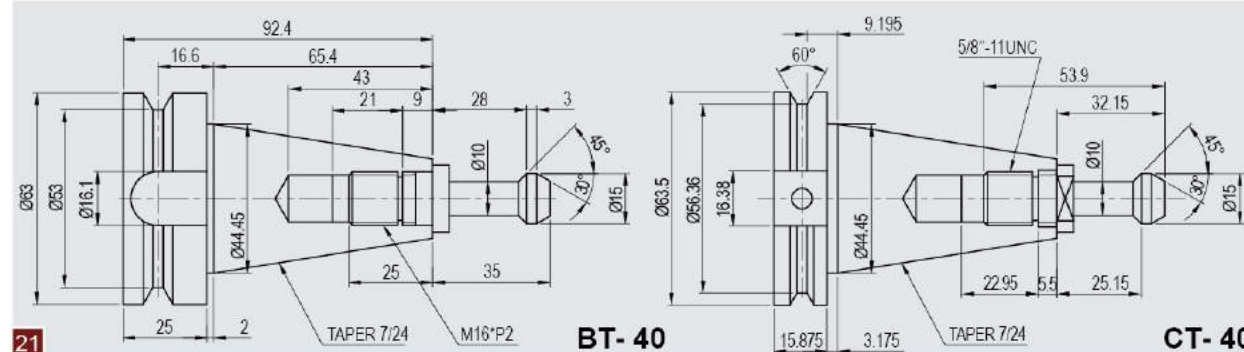

21 TOOL SHANK & PULL STUD

Note: Some accessories are installed at the factory. Please verify before purchasing. Thanks!



| Model   |  | Bed Mill-1054                                   | Bed Mill-1054II                   | ATM 1054II                           | Bed Mill-1454                                   | Bed Mill-1454II                       | ATM-1454II                            |
|---|--|---|-----------------------------------|--------------------------------------|---|---------------------------------------|---------------------------------------|
| Table   | Table Size                                   | 10"x54" (254x1372mm)                            |                                   |                                      | 14"x54" (356x1372mm)                            |                                       |                                       |
|   | T-Slots                                      | 3 x 5/8" (16mm)                                 |                                   |                                      | 3 x 5/8" (16mm)                                 |                                       |                                       |
|   | Table Load                                   | 1320 lbs (600kgs)                               |                                   |                                      | 1960 lbs (891kgs)                               |                                       |                                       |
| Travel  | X Axis Max./ Rapid Feed                      | 31.5"(800mm)/ 200ipm                            |                                   |                                      | 40" (1016mm)/ 200ipm                            |                                       |                                       |
|   | Y Axis Max./ Rapid Feed                      | 20"(500mm)/ 200ipm                              |                                   |                                      | 22.44"(570mm)/ 200ipm                           |                                       |                                       |
|   | Z Axis Max./ Rapid Feed                      | 20.87"(530mm)/ 200ipm                           |                                   |                                      | 26.77"(680mm)/ 200ipm                           |                                       |                                       |
|   | Max Spindle Nose to Table                    | 5.31"(135mm)~25.39" (645mm)                     |                                   |                                      | 1"(25.4mm)~27.75" (705mm)                       |                                       |                                       |
|   | Spindle Center to Column Face                | 23.62" (600mm)                                  |                                   |                                      | 21.3" (540mm)                                   |                                       |                                       |
| Spindle                                       | Quill Diameter                               | 4" (100mm)                                      | 4.72" (120mm)                     |                                      | 4" (100mm)                                      | 4.72" (120mm)                         |                                       |
|   | Quill Travel                                 | 5" (127mm)                                      | -                                 |                                      | 5" (127mm)                                      | -                                     |                                       |
|   | Spindle Taper                                | CAT#40 (BT#40, NMTB#40 Opt.)                    |                                   |                                      | CAT#40 (BT#40, NMTB#40 Opt.)                    |                                       |                                       |
|   | Spindle Speed Hi/Low RPM                     | 60~4500 / 7~570                                 | 0~6000                            |                                      | 60~4500 / 7~570                                 | 0~6000                                |                                       |
|   | Spindle Feed-3 ranges in(mm)/ rev.           | 0.0015", 0.003", 0.006"<br>(0.15, 0.04, 0.08mm) | -                                 |                                      | 0.0015", 0.003", 0.006"<br>(0.15, 0.04, 0.08mm) | -                                     |                                       |
|   | Spindle Rotation Angle                       | ±90° left to right                              |                                   | ±90° left to right                   |   | ±90° left to right                    |                                       |
| Motor   | Spindle HP                                   | 5   | 7.5                               |                                      | 5   | 7.5                                   |                                       |
|   | X Axis Servo Motor                           | DC 31.3 in-lb or AC 750watts                    |                                   |                                      | DC 31.3 in-lb or AC 1.5KW                       |                                       |                                       |
|   | Y Axis Servo Motor                           | DC 31.3 in-lb or AC 750watts                    |                                   |                                      | DC 31.3 in-lb or AC 1.5 KW                      |                                       |                                       |
|   | Z Axis Servo Motor                           | DC 31.3 in-lb or AC 1 KW with brake             |                                   |                                      | DC 31.3 in-lb or AC 2.2 KW                      |                                       |                                       |
|   | Coolant Pump HP (Opt.)                       | 1/8   |                                   |                                      | 1/8   |                                       |                                       |
|   | Lubrication Pump Watts                       | 80  |                                   |                                      | 80  |                                       |                                       |
| ATC Tool Dimension & Capacity                 | Tool Total Length                            | -   |                                   | 8.66" (220mm)                        | -   |                                       | 12" (300mm)                           |
|   | Tool Maximum Width                           | -   |                                   | 2.95" (75mm)                         | -   |                                       | 2.95" (75mm)                          |
|   | Tool Total Weight                            | -   |                                   | 15 lbs (8kgs)                        | -   |                                       | 15 lbs (8kgs)                         |
|   | Total Tool Number                            | -   |                                   | 8, 10 or 12                          | -   |                                       | 8, 10 or 12                           |
| Power   | Control                                      | 110V/ 1P/ 20A or 230V/ 3P/ 50A                  |                                   | 230/ 3P/ 50A                         | 110V/ 1P/ 20A or 230V/ 3P/ 50A                  |                                       |                                       |
|   | Machine                                      | 230V(460V)/ 3P/ 14A(7A) or single phase 230V    |                                   | 12.5KVA                              | 230V(460V)/ 3P/ 14A(7A) or single phase 230V    |                                       |                                       |
| Air Req.                                      | Pneumatic Pressure                           | -   | 85psi (6kg/cm <sup>2</sup> ) min. |                                      | -   | 85psi (6kg/cm <sup>2</sup> ) min.     |                                       |
| Dimension                                     | Max Height                                   | 100" (2540mm)                                   |                                   | 97.64" (2480mm)                      | 104.7" (2660mm)                                 |                                       |                                       |
|   | Height from Table Top to Bottom of Bed       | 35.43" (900mm)                                  |                                   |                                      | 31.5" (800mm)                                   |                                       |                                       |
|   | Width of Machine Including Table             | 76.44" (1945mm)                                 |                                   |                                      | 94.49" (2400mm)                                 |                                       |                                       |
|   | Overall Length with Electrical Door Closed   | 80.71" (2050mm)                                 |                                   |                                      | 84.65" (2150mm)                                 |                                       |                                       |
|   | Overall Length with Electrical Door Open     | 103.15" (2620mm)                                |                                   |                                      | 109.06" (2770mm)                                |                                       |                                       |
|   | Overall Width with Full Table Traverse       | 108.27" (2750mm)                                |                                   |                                      | 141.73"(3600mm)                                 |                                       |                                       |
|   | Footprint of Machine inches                  | 76.44" x78.74" x100"                            |                                   |                                      | 100" x 74" x110"                                |                                       |                                       |
|   | Footprint of Machine metric                  | 1945x2000x2540mm                                |                                   |                                      | 2540x1880x2794mm                                |                                       |                                       |
| Weight  | Net Approx.                                  | 4558 lbs (2072 kgs)                             | 5001 lbs (2273 kgs)               | 5896 lbs (2680 kgs)                  | 6058 lbs (2748 kgs)                             | 6327 lbs (2870 kgs)                   | 7612 lbs (3460 kgs)                   |
|   | Gross Approx.                                | 4558 lbs (2185 kgs)                             | 5254 lbs (2388 kgs)               | 6235 lbs (2834 kgs)                  | 6336 lbs (2874 kgs)                             | 6605 lbs (2996 kgs)                   | 7880 lbs (3582 kgs)                   |
| Packing Dimension Approx.                     | X x Y x Z inch (metric)<br>w/balancing block | 86.22"x75.2"x85.83"<br>219x191x218cm            |                                   | 86.22"x75.2"x99.61"<br>219x191x253cm | 90.55"x78.74"x88.58"<br>230x200x225cm           | 90.55"x78.74"x96.46"<br>230x200x245cm | 90.55"x90.55"x96.46"<br>230x230x245cm |
| <b>Maximum Working Capacity in Mild Steel</b> |  |   |                                   |                                      |   |                                       |                                       |
| Drilling Max Capacity                         | Φ1-1/4" (32mm)                               |   | Φ1-1/2" (38mm)                    |                                      | Φ1-1/4" (32mm)                                  |                                       | Φ1-1/2" (38mm)                        |
| Milling Max Capacity                          | 3mm x Φ100mm                                 |   | 5mm x Φ100mm                      |                                      | 3mm x Φ100mm                                    |                                       | 5mm x Φ100mm                          |
| Boring Capacity                               | Φ4.75" (120mm)                               |   | Φ6.3" (160mm)                     |                                      | Φ4.75" (120mm)                                  |                                       | Φ6.3" (160mm)                         |
| Tapping Max Capacity                          | 1" (25mm)                                    |   | 1.18" (30mm)                      |                                      | 1" (25mm)                                       |                                       | 1.18" (30mm)                          |
| Handwheel Type (Opt.)                         | Electronic MPG                               |   |                                   |                                      | Electronic MPG                                  |                                       |                                       |

Note: The manufacturer reserves the right to modify the design, specification, mechanisms, etc., to improve the performance of the machine without prior notice.  
All specifications shown above are for reference only!