

CNC

8060

8065

Operating manual

(Ref: 1402)



FAGOR AUTOMATION

MACHINE SAFETY

It is up to the machine manufacturer to make sure that the safety of the machine is enabled in order to prevent personal injury and damage to the CNC or to the products connected to it. On start-up and while validating CNC parameters, it checks the status of the following safety elements. If any of them is disabled, the CNC shows a warning message.

- Feedback alarm for analog axes.
- Software limits for analog and sercos linear axes.
- Following error monitoring for analog and sercos axes (except the spindle) both at the CNC and at the drives.
- Tendency test on analog axes.

FAGOR AUTOMATION shall not be held responsible for any personal injuries or physical damage caused or suffered by the CNC resulting from any of the safety elements being disabled.

HARDWARE EXPANSIONS

FAGOR AUTOMATION shall not be held responsible for any personal injuries or physical damage caused or suffered by the CNC resulting from any hardware manipulation by personnel unauthorized by Fagor Automation.

If the CNC hardware is modified by personnel unauthorized by Fagor Automation, it will no longer be under warranty.

COMPUTER VIRUSES

FAGOR AUTOMATION guarantees that the software installed contains no computer viruses. It is up to the user to keep the unit virus free in order to guarantee its proper operation.

Computer viruses at the CNC may cause it to malfunction. An antivirus software is highly recommended if the CNC is connected directly to another PC, it is part of a computer network or floppy disks or other computer media is used to transmit data.

FAGOR AUTOMATION shall not be held responsible for any personal injuries or physical damage caused or suffered by the CNC due a computer virus in the system.

If a computer virus is found in the system, the unit will no longer be under warranty.



All rights reserved. No part of this documentation may be transmitted, transcribed, stored in a backup device or translated into another language without Fagor Automation's consent. Unauthorized copying or distributing of this software is prohibited.

The information described in this manual may be changed due to technical modifications. Fagor Automation reserves the right to make any changes to the contents of this manual without prior notice.

All the trade marks appearing in the manual belong to the corresponding owners. The use of these marks by third parties for their own purpose could violate the rights of the owners.

It is possible that CNC can execute more functions than those described in its associated documentation; however, Fagor Automation does not guarantee the validity of those applications. Therefore, except under the express permission from Fagor Automation, any CNC application that is not described in the documentation must be considered as "impossible". In any case, Fagor Automation shall not be held responsible for any personal injuries or physical damage caused or suffered by the CNC if it is used in any way other than as explained in the related documentation.

The content of this manual and its validity for the product described here has been verified. Even so, involuntary errors are possible, thus no absolute match is guaranteed. Anyway, the contents of the manual is periodically checked making and including the necessary corrections in a future edition. We appreciate your suggestions for improvement.

The examples described in this manual are for learning purposes. Before using them in industrial applications, they must be properly adapted making sure that the safety regulations are fully met.

INDEX

About the product	9
Declaration of conformity	13
Declaration of conformity	15
Version history	17
Safety conditions	19
Warranty terms	23
Material returning terms.....	25
CNC maintenance	27

CHAPTER 1 DESCRIPTION OF THE KEYS

1.1 Monitor LCD-15. (8065)	29
1.2 Monitor LCD-10K (option 1). (8065)	30
1.3 Monitor LCD-10K (option 2). (8065)	32
1.4 HORIZONTAL KEYB / HORIZONTAL KEYB + MOUSE. (8065)	34
1.5 VERTICAL KEYB / VERTICAL KEYB + MOUSE. (8065).....	35
1.6 HORIZONTAL KEYB. (8060)	36
1.7 VERTICAL KEYB. (8060)	38
1.8 OP PANEL / OP PANEL + SPDL RATE. (8065)	40
1.9 OP PANEL. (8060)	41
1.10 Keyboard shortcuts.....	42

CHAPTER 2 GENERAL CONCEPTS

2.1 Turning the CNC on and off.....	43
2.1.1 Emergency shutdown with battery (8065 only).....	45
2.2 Work modes and software protection at the CNC.....	46
2.3 Ethernet.	49
2.4 USB.	49

CHAPTER 3 HOW TO OPERATE THE CNC

3.1 General description of the interface.....	51
3.2 Detailed description of the CNC status bar.....	52
3.2.1 Channel synchronization window.....	53
3.2.2 PLC messages.....	54
3.3 Horizontal softkey menu	55
3.4 Operating modes	56
3.4.1 Description of the various operating modes.....	58
3.5 Task window	60
3.6 Windows for warnings and errors	61
3.6.1 CNC warnings and errors.....	61
3.6.2 PLC errors.....	62
3.7 File selection window	63
3.8 Calculator.....	65
3.8.1 Defining expressions.....	67
3.9 Dialog boxes	69

CHAPTER 4 AUTOMATIC MODE

4.1 Interface description.....	71
4.1.1 Softkey menus	73
4.2 Display the status of the program or of the active subroutines.	74
4.3 Program simulation and execution.....	75
4.3.1 Select program.....	75
4.3.2 Select the first and last blocks of the execution.	76
4.3.3 Execute a program.....	78
4.3.4 Resume the execution of a program from the block where it was canceled.	79
4.3.5 Cancel the execution and resume from another block while keeping the history.	80
4.3.6 Simulated execution of a program.	81
4.3.7 Execute a program (retrace).....	84
4.3.8 Executing a program in 8055 MC/TC language.....	87
4.4 Executing program blocks separately.....	88
4.5 Tool inspection.	89
4.5.1 Tool inspection (execution in retrace mode, independent interpolator or rigid tapping).....	89



CNC 8060
CNC 8065

(REF: 1402)

4.6	Block search.....	94
4.6.1	Treatment of functions M, H, F, S.....	96
4.7	Show/hide the dynamic override of the HSC.....	97

CHAPTER 5 **MANUAL (JOG) MODE**

5.1	Interface description.....	99
5.1.1	Softkey menus.....	101
5.2	Operations with the axes.....	102
5.2.1	Home search.....	102
5.2.2	Jog.....	103
5.2.3	Jogging the axes with handwheels.....	105
5.2.4	Moving an axis to a particular position (coordinate).....	107
5.2.5	Coordinate preset.....	107
5.3	Spindle control.....	108
5.4	Tool selection and tool change.....	109
5.5	Setting the feedrate and spindle speed.....	110
5.6	Setting and activating the zero offsets and the fixture offsets.....	111

CHAPTER 6 **MANUAL (JOG) MODE. TOOL CALIBRATION**

6.1	Manual calibration. Calibration without a probe.....	115
6.2	Semi-automatic calibration. Calibration with a probe.....	119
6.3	Automatic calibration with a probe and a canned cycle.....	122
6.3.1	Mill or lathe model ("trihedron" geometrical configuration).....	122
6.3.2	Lathe model ("plane" geometrical configuration).....	125

CHAPTER 7 **MANUAL (JOG) MODE. PART CENTERING (MILL MODEL)**

7.1	How to define the data.....	128
7.2	Data programming.....	129
7.3	Basic operation.....	132

CHAPTER 8 **EDISIMU MODE (EDITING AND SIMULATION)**

8.1	Interface description.....	135
8.1.1	Softkey menus.....	137
8.2	Program editing and simulation.....	138
8.2.1	Program editing.....	138
8.2.2	Editing a program in the 8055 CNC language.....	139
8.2.3	Program simulation.....	141
8.2.4	Simulation errors.....	143
8.3	Editing window.....	144
8.3.1	Softkey and hotkey menus.....	146
8.3.2	Contextual programming assistance.....	147
8.3.3	Help for programming subroutines.....	148
8.3.4	Syntax errors when editing.....	149
8.4	Working in the editing window.....	150
8.4.1	Select a program.....	150
8.4.2	Operations with blocks. Cut and paste.....	150
8.4.3	Find a line or a text in the program.....	151
8.4.4	Undo and redo.....	151
8.4.5	Operations with files.....	152
8.4.6	Customizing the editor.....	153
8.4.7	TEACH-IN.....	155
8.4.8	Import DXF files.....	156
8.4.9	Profile editor.....	157
8.4.10	Canned cycle editor.....	157
8.4.11	Inclined planes (-M- model).....	158
8.4.12	Geometric-help editor (-M- model).....	159
8.5	Graphics window.....	160
8.6	Program window.....	161
8.7	Working in the program window.....	162
8.7.1	Select the first and last blocks of the execution.....	162
8.7.2	Simulate program blocks separately.....	164
8.7.3	Display the status of the program or of the active subroutines.....	165
8.8	Statistics window.....	166
8.8.1	Time estimates.....	167

CHAPTER 9 **PROFILE EDITOR**

9.1	Interface description.....	169
9.1.1	How to use the profile editor.....	171



CNC 8060
CNC 8065

(REF: 1402)

9.2	Define a new profile, enlarge an existing one or import one from a file.....	172
9.2.1	Define any profile using straight and curved sections.....	173
9.2.2	Define a circular profile.....	175
9.2.3	Define a rectangular profile.....	176
9.2.4	Enlarge a profile.....	176
9.2.5	Import a profile from a DXF file.....	177
9.3	Modify a profile and insert corners.....	179
9.4	Configuring the profile editor. Displayed area.....	181
9.5	Configuring the profile editor. Define the work plane.....	181
9.6	End the session at the editor.....	181
9.7	Examples of how to define profiles.....	182
9.7.1	Profile editor. Example 1 (milling).....	182
9.7.2	Profile editor. Example 2 (milling).....	183
9.7.3	Profile editor. Example 3 (milling).....	185
9.7.4	Profile editor. Example 4 (lathe).....	186

CHAPTER 10 GRAPHIC ENVIRONMENT (MILL MODEL)

10.1	Description of the graphic environment.....	187
10.1.1	Softkey menus.....	188
10.2	Type of graphics.....	189
10.3	Zoom.....	190
10.4	Dimensions.....	191
10.5	Point of view.....	191
10.6	Measurement.....	192
10.7	Clear screen.....	193
10.8	Colors.....	193
10.9	Options.....	194
10.10	Real coordinates.....	195
10.11	Real coordinates with enlarged error.....	195
10.12	Simulation speed.....	195

CHAPTER 11 HD GRAPHIC ENVIRONMENT (MILL MODEL)

11.1	Description of the graphic environment.....	197
11.1.1	Softkey menus.....	198
11.2	Move, rotate and zoom in or out on the graphic.....	199
11.3	Select the type of view.....	200
11.4	Configure the graphics (number of windows, colors, etc.).....	201
11.5	Actions (move sections and print graphics).....	204
11.6	Delete the graphic.....	205
11.7	Define the dimensions of the parts and the size of the graphic.....	205
11.8	Measure the part.....	206
11.9	Simulation speed.....	206

CHAPTER 12 GRAPHIC ENVIRONMENT (LATHE MODEL)

12.1	Description of the graphic environment.....	207
12.1.1	Softkey menus.....	208
12.2	Type of graphics.....	209
12.3	Zoom.....	210
12.4	Dimensions.....	211
12.5	Measurement.....	211
12.6	Clear screen.....	212
12.7	Colors.....	212
12.8	Options.....	213
12.9	Real coordinates.....	214
12.10	Real coordinates with enlarged error.....	214
12.11	Simulation speed.....	214

CHAPTER 13 HD GRAPHIC ENVIRONMENT (LATHE MODEL)

13.1	Description of the graphic environment.....	215
13.1.1	Softkey menus.....	216
13.2	Move, rotate and zoom in or out on the graphic.....	217
13.3	Select the type of view.....	218
13.4	Configure the graphics (number of windows, colors, etc.).....	219
13.5	Actions (move sections and print graphics).....	222
13.6	Delete the graphic.....	223
13.7	Define the dimensions of the parts and the size of the graphic.....	223
13.8	Measure the part.....	224
13.9	Simulation speed.....	224



CNC 8060
CNC 8065

(REF: 1402)

CHAPTER 14**MDI/MDA MODE**

14.1	Interface description.	225
14.1.1	Softkey menus.	226
14.2	Edit and execute individual blocks.	227
14.3	Block history.	228

CHAPTER 15**USER TABLES**

15.1	User table presentation.	229
15.1.1	Softkey menus.	230
15.2	Zero offset tables.	231
15.3	Fixture table.	233
15.4	Arithmetic parameter tables.	234
15.5	Operations with tables.	235
15.5.1	Data editing.	235
15.5.2	Save and recall tables.	235
15.5.3	Find text.	237

CHAPTER 16**TOOL AND MAGAZINE TABLE**

16.1	Presentation of the tool tables and magazine tables.	239
16.1.1	Softkey menus.	240
16.1.2	Search for a text in the tables.	241
16.1.3	Save and load the tables.	242
16.1.4	Printing the tables.	244
16.2	Tool table.	245
16.3	Tool and tool magazine table.	247
16.3.1	Vertical softkey menu.	247
16.3.2	The tool list.	248
16.3.3	Description of the tool data.	249
16.4	Tool table (simple mode).	257
16.4.1	Vertical softkey menu.	257
16.4.2	Configuring the tool data display.	257
16.4.3	Data of the M tools (standard page - screen-).	258
16.4.4	Data of the T tools (standard page - screen-).	259
16.4.5	Data of the M/T tools (offset page - screen-).	260
16.4.6	Editing the tool table.	260
16.5	Operations with the tool table (full mode).	261
16.5.1	Editing the tool table.	261
16.6	Active-tools table.	262
16.6.1	Softkey menus.	263
16.6.2	Changing the tool of the spindle.	263
16.7	Table for the status of the tool change process.	264
16.8	Magazine table.	265
16.8.1	Softkey menus.	266
16.8.2	List of magazine positions.	267
16.8.3	Magazine information.	268
16.9	Operations with the magazine table.	270
16.9.1	Loading / unloading tools to / from the magazine.	270
16.9.2	Load / unload a tool to / from the tool changer arm.	272

CHAPTER 17**UTILITIES MODE**

17.1	Interface description.	273
17.1.1	Softkey menus.	274
17.2	Set how to display the list of programs.	275
17.3	Select files and create folders.	276
17.4	Search in files.	277
17.5	Protection passwords.	278
17.6	Data safety backup. Backup - Restore.	280
17.7	Encrypting files.	282

CHAPTER 18**PLC**

18.1	Appearance of the PLC mode.	283
18.1.1	Icon description (vertical softkeys).	284
18.2	"Programs" service.	285
18.2.1	Softkey menus. PLC project.	286
18.2.2	Softkey menus. Files of the PLC project.	287
18.3	Program editing.	288



CNC 8060
CNC 8065

(REF: 1402)

18.4	Editing in C language or mnemonic language.....	290
18.4.1	Softkey "Analyze".....	291
18.4.2	Softkey "File".....	291
18.4.3	Softkey "Undo".....	291
18.4.4	Softkey "Operations with blocks".....	292
18.4.5	Softkey "Find/Replace".....	293
18.4.6	Softkey "Customize".....	294
18.5	Editing in contact (ladder) language (softkeys).....	295
18.5.1	Softkey "Analyze".....	296
18.5.2	Softkey "File".....	296
18.5.3	"Edit" softkey.....	297
18.5.4	Softkey "View".....	299
18.5.5	Softkey "Marks".....	299
18.5.6	Softkey "Find".....	300
18.5.7	Softkey "Customize".....	300
18.6	Program monitoring.....	301
18.6.1	Softkey menus. Monitoring in C language or mnemonic language.....	302
18.6.2	Softkey menus. Monitoring in contact (ladder) language.....	303
18.7	"Commands" service.....	305
18.7.1	Softkey menus. Options of the "Commands" service.....	305
18.8	"Outputs" service.....	306
18.8.1	Softkey menus. Options of the "Outputs" service.....	307
18.9	"Logic analyzer" service.....	308
18.9.1	Editing logic analyzer data.....	309
18.9.2	Save, load and reset the analyzer configuration.....	311
18.9.3	Execute and analyze trace.....	312
18.9.4	Customize the appearance of the logic analyzer.....	312
18.10	"Monitoring" service.....	313
18.10.1	Description of resource tables.....	314
18.10.2	Definition of the table resources.....	315
18.10.3	Options of the "Monitoring" service (softkeys).....	316
18.11	"Cross references" service.....	317
18.11.1	Softkey menus. Options of the "Cross reference" service.....	318
18.12	"Statistics" service.....	319
18.12.1	Softkey menus. Options of the "Statistics" service.....	320
18.13	"Messages" service.....	321
18.13.1	Softkey menus. Options of the "Messages" service.....	322
18.13.2	Editing the message and error table.....	323
18.13.3	Displaying PLC messages.....	324
18.13.4	Displaying PLC errors.....	325
18.13.5	Grouping the additional information text files in a single file.....	326
18.13.6	Save, load and print a message and error table.....	327

CHAPTER 19 MACHINE PARAMETERS

19.1	Appearance of the machine parameter tables.....	329
19.1.1	Softkey menus.....	330
19.2	Parameter table description.....	331
19.2.1	"M" function setting table.....	332
19.2.2	Compensation table.....	333
19.2.3	OEM parameters.....	334
19.3	Operations with tables.....	335
19.3.1	Data editing and validation.....	335
19.3.2	Save and recall tables.....	336
19.3.3	Find text.....	337
19.3.4	Importing and exporting compensation tables.....	338

CHAPTER 20 SETUP ASSISTANCE

20.1	Oscilloscope.....	340
20.1.1	Interface description.....	341
20.1.2	Softkey menus.....	342
20.1.3	Configuration screen.....	345
20.1.4	Configure and execute the oscilloscope function.....	346
20.1.5	Machine parameter editing.....	347
20.2	The Bode diagram.....	350
20.2.1	Interface description.....	351
20.2.2	Softkey menus.....	352
20.2.3	Machine parameter editing.....	355
20.2.4	Configuration screen.....	357



CNC 8060
CNC 8065

(REF: 1402)

20.3	The circularity (roundness) test	360
20.3.1	Interface description.....	361
20.3.2	Softkey menus	363
20.3.3	Configuring and executing the circularity (roundness) test	364
20.3.4	Configure the graphic environment.....	365
20.3.5	Define and execute the movement subroutine	366
20.3.6	Data capture for the graphic	367
20.3.7	Adjustment of the machine parameters involved	368
20.3.8	Validate the changes and save the configuration used	370
20.3.9	Machine parameters that may be modified.....	371

CHAPTER 21 **DDSETUP**

21.1	Appearance of the DDSSetup mode	373
21.1.1	Icon description (vertical softkeys).....	374
21.2	List of devices connected to the bus.....	375
21.3	Drives accessing level (only Sercos).....	377
21.4	–Parameters and variables– service.....	378
21.5	–Error management– service.....	380
21.6	–Monitoring– service.....	381
21.7	–Information– service	383
21.8	Command generator (only Sercos).....	385
21.9	Command line.....	386
21.10	File for setting the parameters of Mechatrolink servos.....	388

CHAPTER 22 **DIAGNOSIS**

22.1	Appearance of the diagnosis mode	391
22.1.1	Softkey menus	392
22.2	Configuration diagnosis	393
22.2.1	System diagnosis.....	393
22.2.2	Software diagnosis.....	394
22.2.3	Hardware diagnosis. Bus CAN, Sercos and Mechatrolink.....	395
22.3	Sercos diagnosis	397
22.4	Save the CAN configuration for the start-up test	398
22.5	Report generation	399
22.6	View the history of errors and warnings issued by the CNC.....	400
22.7	Generating the Fagor file for error diagnosis.....	400
22.8	Access particular utilities of the operative system and other applications.....	400



CNC 8060
CNC 8065

(REF: 1402)

ABOUT THE PRODUCT

BASIC CHARACTERISTICS.

Basic characteristics.	8060 M	8060 T	8065 M	8065 T
PC-based system.	Closed system		Open system	
Operating system.	Windows XPe		Windows XP	
Number of axes.	3 a 5		3 to 28	
Number of spindles.	1	2	1 to 4	
Number of tool magazines.	1	2	1 to 4	
Number of execution channels.	1	2	1 to 4	
Number of handwheels.	1 a 3		1 to 12	
Type of servo system.	Analog / Sercos Digital		Analog / Digital Sercos / Digital Mechatrolink	
Communications.	RS485 / RS422 / RS232 Ethernet			
Integrated PLC.				
PLC execution time.	< 1ms/K			
Digital inputs / Digital outputs.	1024 / 1024			
Marks / Registers.	8192 / 1024			
Timers / Counters.	512 / 256			
Symbols.	Unlimited			
Block processing time.	< 1.5 ms		< 1 ms	

Remote modules.	RIOW	RIO5	RIO70	RCS-S
Communication with the remote modules.	CANopen	CANopen	CANfagor	Sercos
Digital inputs per module.	8	16 / 32	16	---
Digital outputs per module.	8	24 / 48	16	---
Analog inputs per module.	4	4	8	---
Analog outputs per module.	4	4	4	4
Inputs for PT100 temperature sensors.	2	2	---	---
Feedback inputs.	---	---	4 (*)	4 (**)

(*) Differential TTL / Sinusoidal 1 Vpp (**) TTL / Differential TTL / Sinusoidal 1 Vpp / SSI protocol

Customizing (on an open system only).

PC-based open system, fully customizable.
 INI configuration files.
 FGUIM visual configuration tool.
 Visual Basic®, Visual C++®, etc.
 Internal databases in Microsoft® Access.
 OPC compatible interface



CNC 8060
CNC 8065

(REF: 1402)

SOFTWARE OPTIONS.

Bear in mind that some of the features described in this manual depend on the software options that are installed. The information of the following table is informative only; when purchasing the software options, only the information provided in the ordering handbook is valid.

Software options (.M· model).

	8060 M	8065 M		8065 M Power	
		Basic	Pack 1	Basic	Pack 1
Open system. Access to the administrator mode.	---	---	---	Option	Option
Number of execution channels	1	1	1	1	1 to 4
Number of axes	3 a 5	3 to 6	5 to 8	5 to 12	8 to 28
Number of spindles	1	1	1 to 2	1 to 4	1 to 4
Number of tool magazines	1	1	1	1 to 2	1 to 4
Limited to 4 interpolated axes	Option	Option	Option	Option	Option
IEC 61131 language	---	---	Option	Option	Option
HD graphics	Option	Option	Option	Standard	Standard
Conversational IIP	Option	Option	Option	Option	Option
Dual-purpose machines (M-T)	---	---	---	Option	Standard
"C" axis	Option	Standard	Standard	Standard	Standard
Dynamic RTCP	Option	---	Option	Option	Standard
HSSA machining system.	Option	Standard	Standard	Standard	Standard
Probing canned cycles	Option	Option	Standard	Standard	Standard
Tandem axes	Option	---	Option	Standard	Standard
Synchronism and cams	---	---	---	Option	Standard
Tangential control	---	---	Standard	Standard	Standard
Volumetric compensation (up to 10 m ³).	---	---	---	Option	Option
Volumetric compensation (more than 10 m ³).	---	---	---	Option	Option
ProGTL3 language.	Option	Option	Option	Option	Option
Part-program translator.	Option	Option	Option	Option	Option



CNC 8060
CNC 8065

(REF: 1402)

Software options (-T- model).

	8060 T	8065 T		8065 T Power	
		Basic	Pack 1	Basic	Pack 1
Open system. Access to the administrator mode.	---	---	---	Option	Option
Number of execution channels	2	1	1 to 2	1 to 2	1 to 4
Number of axes	3 a 5	3 to 5	5 to 7	5 to 12	8 to 28
Number of spindles	2	2	2	3 to 4	3 to 4
Number of tool magazines	2	1	1 to 2	1 to 2	1 to 4
Limited to 4 interpolated axes	Option	Option	Option	Option	Option
IEC 61131 language	---	---	Option	Option	Option
HD graphics	Option	Option	Option	Standard	Standard
Conversational IIP	Option	Option	Option	Option	Option
Dual-purpose machines (T-M)	---	---	---	Option	Standard
"C" axis	Option	Option	Standard	Standard	Standard
Dynamic RTCP	---	---	---	Option	Standard
HSSA machining system.	Option	Option	Standard	Standard	Standard
Probing canned cycles	Option	Option	Standard	Standard	Standard
Tandem axes	Option	---	Option	Standard	Standard
Synchronism and cams	Option	---	Option	Option	Standard
Tangential control	---	---	---	Option	Standard
Volumetric compensation (up to 10 m³).	---	---	---	Option	Option
Volumetric compensation (more than 10 m³).	---	---	---	Option	Option
ProGTL3 language.	---	---	---	---	---
Part-program translator.	Option	---	---	---	---

DECLARATION OF CONFORMITY

The manufacturer:

Fagor Automation S. Coop.
Barrio de San Andrés Nº 19, C.P.20500, Mondragón -Guipúzcoa- (Spain).

Declares:

The manufacturer declares under their exclusive responsibility the conformity of the product:

8060 CNC

Consisting of the following modules and accessories:

CN60-10H, CN60-10HT, CN60-10V, CN60-10VT
OP-PANEL, OP-PANEL+SPDL RATE
Remote Modules RIOW, RIO5, RIO70, RCS-S, RIOR.

Note.Some additional characters may follow the model references indicated above. They all comply with the directives listed here. However, compliance may be verified on the label of the unit itself.

Referred to by this declaration with following directives:

Low-voltage regulations.

IEC 60204-1:2005/A1:2008 Electrical equipment on machines. Part1. General requirements.

Regulation on electromagnetic compatibility.

EN 61131-2: 2007 PLC. Part 2. Equipment requirements and tests.

According to the European Community Directives 2006/95/EC on Low Voltage and 2004/108/EC on Electromagnetic Compatibility and their updates.

In Mondragón, February 1st, 2014.

Fagor Automation, S. Coop.

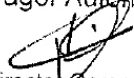
Director Gerente
Pedro Ruiz de Aguirre

FAGOR 

CNC 8060
CNC 8065

(REF: 1402)

DECLARATION OF CONFORMITY

The manufacturer:

Fagor Automation S. Coop.
Barrio de San Andrés Nº 19, C.P.20500, Mondragón -Guipúzcoa- (Spain).

Declares:

The manufacturer declares under their exclusive responsibility the conformity of the product:

8065 CNC

Consisting of the following modules and accessories:

8065-M-ICU, 8065-T-ICU
MONITOR-LCD-10K, MONITOR-LCD-15, MONITOR-SVGA-15
HORIZONTAL-KEYB, VERTICAL-KEYB, OP-PANEL
BATTERY
Remote Modules RIOW, RIO5, RIO70, RCS-S.

Note.Some additional characters may follow the model references indicated above. They all comply with the directives listed here. However, compliance may be verified on the label of the unit itself.

Referred to by this declaration with following directives:

Low-voltage regulations.

IEC 60204-1:2005/A1:2008 Electrical equipment on machines. Part1. General requirements.

Regulation on electromagnetic compatibility.

EN 61131-2: 2007 PLC. Part 2. Equipment requirements and tests.

According to the European Community Directives 2006/95/EC on Low Voltage and 2004/108/EC on Electromagnetic Compatibility and their updates.

In Mondragón, September 1st, 2013.

Fagor Automation, S. Coop.

Director Gerente
Pedro Ruiz de Aguirre

FAGOR 

CNC 8060
CNC 8065

(REF: 1402)

VERSION HISTORY

Here is a list of the features added to each manual reference.

Ref. 1402

Software V01.00 (8060)

8060. First version.



CNC 8060
CNC 8065

(REF: 1402)

SAFETY CONDITIONS

Read the following safety measures in order to prevent harming people or damage to this product and those products connected to it. Fagor Automation shall not be held responsible of any physical damage or defective unit resulting from not complying with these basic safety regulations.



Before start-up, verify that the machine that integrates this CNC meets the 89/392/CEE Directive.

PRECAUTIONS BEFORE CLEANING THE UNIT

If the CNC does not turn on when actuating the start-up switch, verify the connections.

- Do not get into the inside of the unit.** Only personnel authorized by Fagor Automation may manipulate the inside of this unit.
- Do not handle the connectors with the unit connected to AC power.** Before manipulating the connectors (inputs/outputs, feedback, etc.) make sure that the unit is not connected to AC power.

PRECAUTIONS DURING REPAIR

In case of a malfunction or failure, disconnect it and call the technical service.

- Do not get into the inside of the unit.** Only personnel authorized by Fagor Automation may manipulate the inside of this unit.
- Do not handle the connectors with the unit connected to AC power.** Before manipulating the connectors (inputs/outputs, feedback, etc.) make sure that the unit is not connected to AC power.

PRECAUTIONS AGAINST PERSONAL DAMAGE

- Interconnection of modules.** Use the connection cables provided with the unit.
- Use proper cables.** To prevent risks, use the proper cables for mains, Sercos and Bus CAN recommended for this unit.
In order to avoid electrical shock at the central unit, use the proper power (mains) cable. Use 3-wire power cables (one for ground connection).
- Avoid electrical overloads.** In order to avoid electrical discharges and fire hazards, do not apply electrical voltage outside the range selected on the rear panel of the central unit.
- Ground connection.** In order to avoid electrical discharges, connect the ground terminals of all the modules to the main ground terminal. Before connecting the inputs and outputs of this unit, make sure that all the grounding connections are properly made.
In order to avoid electrical shock, before turning the unit on verify that the ground connection is properly made.
- Do not work in humid environments.** 8060. In order to avoid electrical discharges, always work under 90% of relative humidity (non-condensing) and 50 °C (122 °F).
8065. In order to avoid electrical discharges, always work under 90% of relative humidity (non-condensing) and 45 °C (113 °F).
- Do not work in explosive environments.** In order to avoid risks or damages, do no work in explosive environments.



CNC 8060
CNC 8065

(REF: 1402)

PRECAUTIONS AGAINST PRODUCT DAMAGE

Working environment.	This unit is ready to be used in industrial environments complying with the directives and regulations effective in the European Community. Fagor Automation shall not be held responsible for any damage suffered or caused by the CNC when installed in other environments (residential or homes).
Install the unit in the right place.	It is recommended, whenever possible, to install the CNC away from coolants, chemical product, blows, etc. that could damage it. This unit complies with the European directives on electromagnetic compatibility. Nevertheless, it is recommended to keep it away from sources of electromagnetic disturbance such as: <ul style="list-style-type: none"> Powerful loads connected to the same AC power line as this equipment. Nearby portable transmitters (Radio-telephones, Ham radio transmitters). Nearby radio/TV transmitters. Nearby arc welding machines. Nearby High Voltage power lines.
Enclosures.	The manufacturer is responsible of assuring that the enclosure involving the equipment meets all the currently effective directives of the European Community.
Avoid disturbances coming from the machine.	The machine must have all the interference generating elements (relay coils, contactors, motors, etc.) uncoupled.
Use the proper power supply.	Use an external regulated 24 Vdc power supply for the keyboard and the remote modules.
Grounding of the power supply.	The zero volt point of the external power supply must be connected to the main ground point of the machine.
Analog inputs and outputs connection.	Use shielded cables connecting all their meshes to the corresponding pin.
Ambient conditions.	8060. The storage temperature must be between +5 °C and +55 °C (41 °F and 131 °F). 8065. The storage temperature must be between +5 °C and +45 °C (41 °F and 113 °F). The storage temperature must be between -25 °C and 70 °C (-13 °F and 158 °F).
Central unit enclosure.	Make sure that the needed gap is kept between the central unit and each wall of the enclosure. Use a DC fan to improve enclosure ventilation.
Main AC power switch.	This switch must be easy to access and at a distance between 0.7 and 1.7 m (2.3 and 5.6 ft) off the floor.

PROTECTIONS OF THE UNIT ITSELF

Remote modules.	All the digital inputs and outputs have galvanic isolation via optocouplers between the CNC circuitry and the outside.
------------------------	--



CNC 8060
CNC 8065

(REF: 1402)

SAFETY SYMBOLS

Symbols that may appear on the manual.



Danger or prohibition symbol.

It indicates actions or operations that may hurt people or damage products.



Warning symbol.

It indicates situations that certain operations could cause and the suggested actions to prevent them.



Obligation symbol.

It indicates actions and operations that must be carried out.



Information symbol.

It indicates notes, warnings and advises.

Symbols that the product may carry.



Ground protection symbol.

It indicates that that point must be under voltage.

WARRANTY TERMS

INITIAL WARRANTY

All products manufactured or marketed by FAGOR carry a 12-month warranty for the end user which could be controlled by the our service network by means of the warranty control system established by FAGOR for this purpose.

In order to prevent the possibility of having the time period from the time a product leaves our warehouse until the end user actually receives it run against this 12-month warranty, FAGOR has set up a warranty control system based on having the manufacturer or agent inform FAGOR of the destination, identification and on-machine installation date, by filling out the document accompanying each FAGOR product in the warranty envelope. This system, besides assuring a full year of warranty to the end user, enables our service network to know about FAGOR equipment coming from other countries into their area of responsibility.

The warranty starting date will be the one appearing as the installation date on the above mentioned document. FAGOR offers the manufacturer or agent 12 months to sell and install the product. This means that the warranty starting date may be up to one year after the product has left our warehouse so long as the warranty control sheet has been sent back to us. This translates into the extension of warranty period to two years since the product left our warehouse. If this sheet has not been sent to us, the warranty period ends 15 months from when the product left our warehouse.

This warranty covers all costs of material and labour involved in repairs at FAGOR carried out to correct malfunctions in the equipment. FAGOR undertakes to repair or replace their products within the period from the moment manufacture begins until 8 years after the date on which it disappears from the catalogue.

It is entirely up to FAGOR to determine whether the repair is or not under warranty.

EXCLUDING CLAUSES

Repairs will be carried out on our premises. Therefore, all expenses incurred as a result of trips made by technical personnel to carry out equipment repairs, despite these being within the above-mentioned period of warranty, are not covered by the warranty.

Said warranty will be applied whenever the equipment has been installed in accordance with instructions, has not be mistreated, has not been damaged by accident or by negligence and has not been tampered with by personnel not authorised by FAGOR. If, once servicing or repairs have been made, the cause of the malfunction cannot be attributed to said elements, the customer is obliged to cover the expenses incurred, in accordance with the tariffs in force.

Other warranties, implicit or explicit, are not covered and FAGOR AUTOMATION cannot be held responsible for other damages which may occur.



CNC 8060
CNC 8065

(REF: 1402)

WARRANTY ON REPAIRS

In a similar way to the initial warranty, FAGOR offers a warranty on standard repairs according to the following conditions:

PERIOD	12 months.
CONCEPT	Covers parts and labor for repairs (or replacements) at the network's own facilities.
EXCLUDING CLAUSES	The same as those applied regarding the chapter on initial warranty. If the repair is carried out within the warranty period, the warranty extension has no effect.

When the customer does not choose the standard repair and just the faulty material has been replaced, the warranty will cover just the replaced parts or components within 12 months.

For sold parts the warranty is 12 months length.

SERVICE CONTRACTS

The SERVICE CONTRACT is available for the distributor or manufacturer who buys and installs our CNC systems.



CNC 8060
CNC 8065

(REF: 1402)

MATERIAL RETURNING TERMS

When sending the central nit or the remote modules, pack them in its original package and packaging material. If the original packaging material is not available, pack it as follows:

- 1 Get a cardboard box whose three inside dimensions are at least 15 cm (6 inches) larger than those of the unit. The cardboard being used to make the box must have a resistance of 170 Kg (375 lb.).
- 2 Attach a label indicating the owner of the unit, person to contact, type of unit and serial number. In case of malfunction also indicate symptom and a brief description of the problem.
- 3 Wrap the unit in a polyethylene roll or similar material to protect it. When sending a central unit with monitor, protect especially the screen.
- 4 Pad the unit inside the cardboard box with poly-utherane foam on all sides.
- 5 Seal the cardboard box with packing tape or industrial staples.



CNC 8060
CNC 8065

(REF: 1402)

CNC MAINTENANCE

CLEANING

The accumulated dirt inside the unit may act as a screen preventing the proper dissipation of the heat generated by the internal circuitry which could result in a harmful overheating of the unit and, consequently, possible malfunctions. Accumulated dirt can sometimes act as an electrical conductor and short-circuit the internal circuitry, especially under high humidity conditions.

To clean the operator panel and the monitor, a smooth cloth should be used which has been dipped into de-ionized water and /or non abrasive dish-washer soap (liquid, never powder) or 75° alcohol. Do not use highly compressed air to clean the unit because it could generate electrostatic discharges.

The plastics used on the front panel are resistant to grease and mineral oils, bases and bleach, dissolved detergents and alcohol. Avoid the action of solvents such as chlorine hydrocarbons, benzole, esters and ether which can damage the plastics used to make the unit's front panel.

PRECAUTIONS BEFORE CLEANING THE UNIT

Fagor Automation shall not be held responsible for any material or physical damage derived from the violation of these basic safety requirements.

- Do not handle the connectors with the unit connected to AC power. Before handling these connectors (I/O, feedback, etc.), make sure that the unit is not connected to main AC power.
- Do not get into the inside of the unit. Only personnel authorized by Fagor Automation may manipulate the inside of this unit.
- If the CNC does not turn on when actuating the start-up switch, verify the connections.



CNC 8060
CNC 8065

(REF: 1402)

DESCRIPTION OF THE KEYS

1

1.1 Monitor LCD-15. (8065).

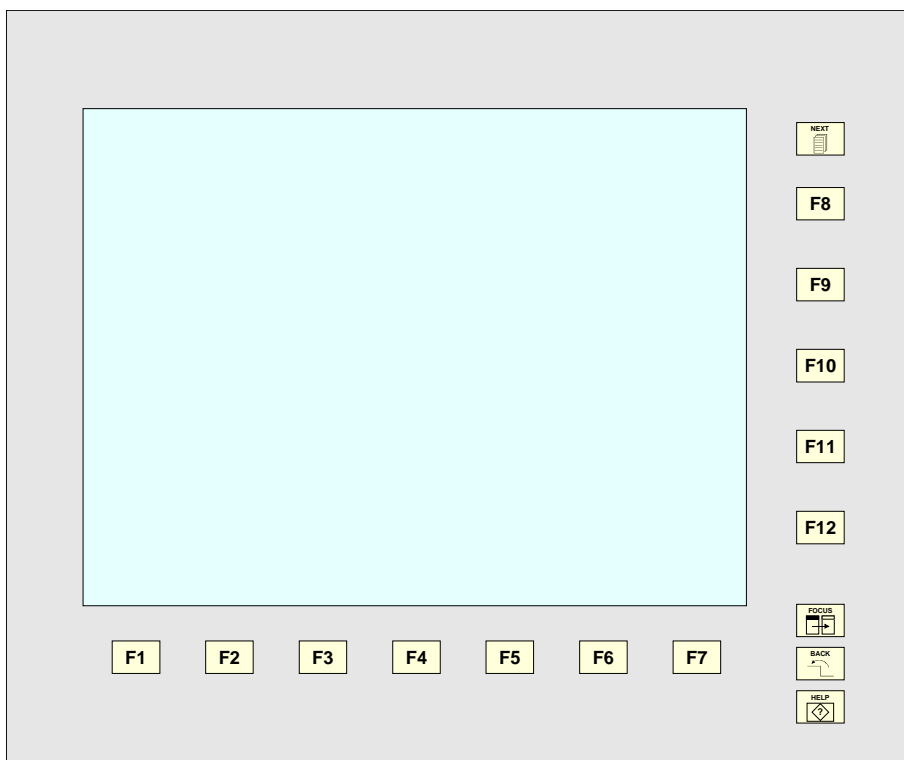

Function keys.

F1 Softkeys.
Keys F1 through F12 select the options of the softkey menus.

 **BACK key.**
On the horizontal softkey menu, it lets you go up from the softkey sub-menu to the previous level from where that menu was accessed.

Browsing keys.

 **NEXT key.**
Configurable key that can carry out one of the following actions.

- Access the various screens of the active work mode sequentially, pressing [SHIFT] at the same time inverts the sequence. In the PLC mode, it switches between the various active services.
- Sequentially access the different channels.
- The horizontal softkey menu shows the available screens and the vertical menu shows the available channels.

Help key.

 **HELP key.**
It accesses the CNC's system help.

 **FOCUS key.**
It is used to switch between the different windows of the screen.

FAGOR 

CNC 8060
CNC 8065

(REF: 1402)

1.2 Monitor LCD-10K (option 1). (8065).

1.

DESCRIPTION OF THE KEYS
Monitor LCD-10K (option 1). (8065).

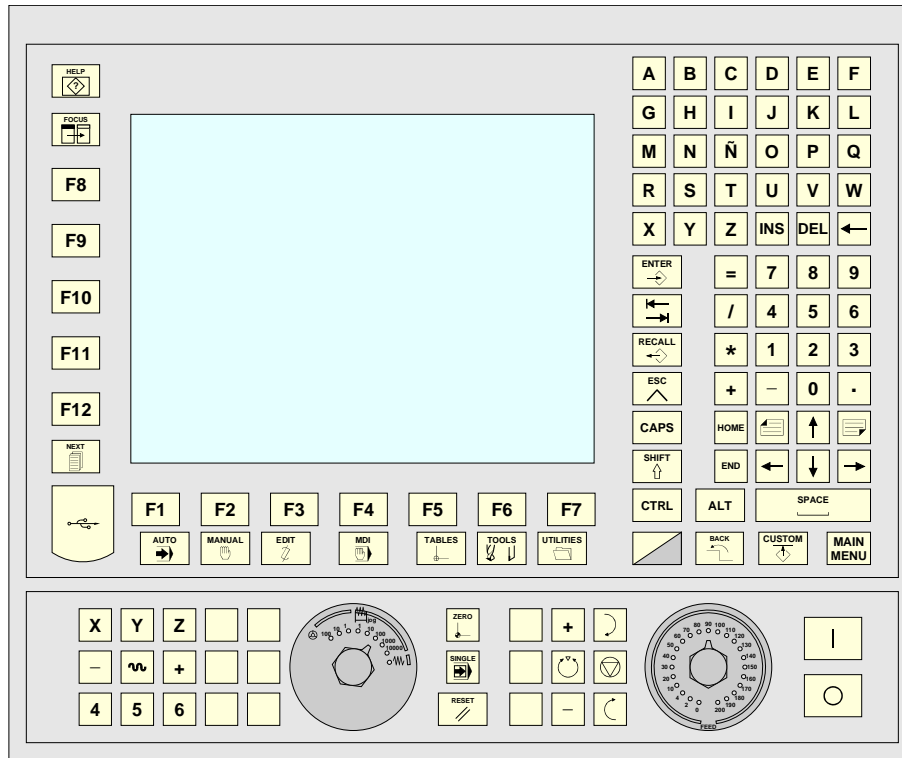

Function keys.

F1 Softkeys.
Keys F1 through F12 select the options of the softkey menus.

Browsing keys.

NEXT key.
Configurable key that can carry out one of the following actions.

- Access the various screens of the active work mode sequentially, pressing [SHIFT] at the same time inverts the sequence. In the PLC mode, it switches between the various active services.
- Sequentially access the different channels.
- The horizontal softkey menu shows the available screens and the vertical menu shows the available channels.

FOCUS key.
It is used to switch between the different windows of the screen.

BACK key.
On the horizontal softkey menu, it lets you go up from the softkey sub-menu to the previous level from where that menu was accessed.

Help key.

HELP key.
It accesses the CNC's system help.

Browsing keys.

MAIN MENU Main menu.
Changing the state of an icon. In the MC/TC mode, it toggles between the standard and the auxiliary screens.

Work modes.

AUTO Automatic mode.
MANUAL Manual (jog) mode.
EDIT EDISIMU mode.
MDI MDI/MDA mode.
TABLES User tables (zero offsets, fixtures and arithmetic parameters).
TOOLS Tool and magazine table.
UTILITIES Utilities mode.
CUSTOM Configurable mode.
OEM-configurable key that can carry out one of the following actions.

- Access a CNC work mode.
- Execute an application.
- Access the operating system.
- Carry out no function at all.







After accessing the work mode, these keys may be used to access the various screens of the active work mode sequentially, pressing [SHIFT] at the same time inverts the sequence.











CNC 8060
CNC 8065

(REF: 1402)









Keys to move the cursor.

-   The arrow keys move the cursor one position to the left, right, up or down.
-   The previous-page or next-page keys show the previous or next page at the part-program or PLC program editor.
-   The home and end keys move the cursor the beginning or end of the line.
-  The tab key moves the cursor to the next field of the active menu.

Editing keys.

-  Shift.
Hold this key down to write upper case letters. When combining this key with a cursor moving key, it selects the text the cursor slides on.
-  Shift lock.
It toggles between uppercase and lowercase letters.
-  ASCII characters.
Hold this key down and key in the corresponding ASCII code.
-  Delete.
-  Delete.
-  Insert or overwrite.
-  Escape key, to cancel the current action without assuming the changes.
-  Key to validate commands, data and program blocks of the editor.
-  Recover data.
While the Teach-in mode is active, this key enters the axes and their current position into the block.
When selecting a profile or conversational canned cycle in the part-program, the key accesses either the profile editor or canned cycle editor accordingly.

Jog keyboard for jogging the axes.

-   Keys to select axes and jog them in the positive direction.
-   Keys to select axes and jog them in the negative direction.
-   Keys to select the axes and keys to select the jogging direction. Both keys (axis and direction) must be pressed to jog the axis.
-   Rapid key. When pressing this key while moving an axis, the CNC applies the rapid feedrate.

Feed selectors.

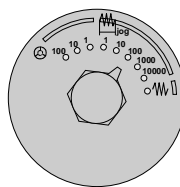

Sector for the type of jog; continuous / incremental jog or handwheels.



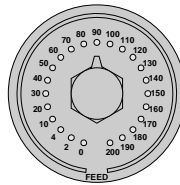

In handwheel mode, it selects the multiplying factor for the handwheel pulses (x1, x10 or x100).

In incremental mode, it selects the incremental value of the axis movements.





Selector of percentage of feedrate override, between 0% and 200%, for jog and automatic movements.



Execution keys.

-  Cycle start key (START).
Execute the selected program in automatic mode, a block in MDI/MDA mode, etc.
-  Cycle stop key (STOP).
Interrupt the execution of the CNC.
-  Reset key.
It initializes the system setting the initial conditions as defined by machine parameters.
-  Single-block execution mode.
When selecting the "single block" execution mode, the program simulation will be interrupted at the end of each block.
-  Home search.

Spindle control.

-  Start the spindle clockwise.
-  Stop the spindle.
-  Start the spindle counterclockwise.
-  To vary the spindle speed percentually.
-  Spindle orientation.

1.

DESCRIPTION OF THE KEYS
Monitor LCD-10K (option 1). (8065).



CNC 8060
CNC 8065

(REF: 1402)

1.3 Monitor LCD-10K (option 2). (8065).

1.

DESCRIPTION OF THE KEYS
Monitor LCD-10K (option 2). (8065).

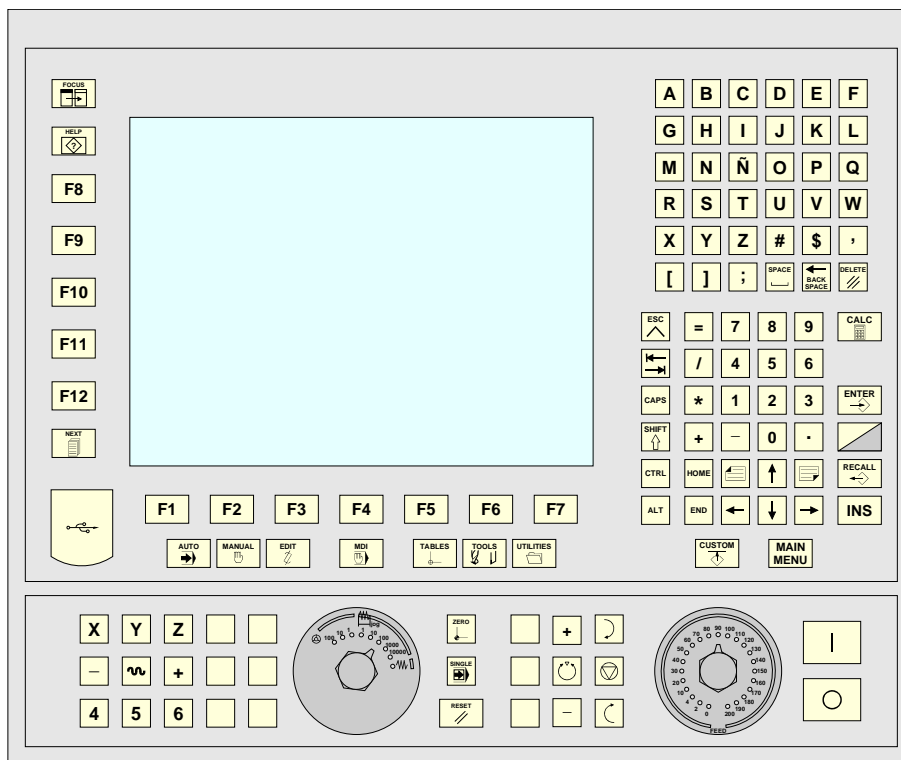

Function keys.

F1 Softkeys.
Keys F1 through F12 select the options of the softkey menus.

Browsing keys.

NEXT key.
Configurable key that can carry out one of the following actions.

- Access the various screens of the active work mode sequentially, pressing [SHIFT] at the same time inverts the sequence. In the PLC mode, it switches between the various active services.
- Sequentially access the different channels.
- The horizontal softkey menu shows the available screens and the vertical menu shows the available channels.

FOCUS key.
It is used to switch between the different windows of the screen.

Help key.

HELP key.
It accesses the CNC's system help.

Browsing keys.

MAIN MENU Main menu.
Changing the state of an icon. In the MC/TC mode, it toggles between the standard and the auxiliary screens.

Work modes.

AUTO Automatic mode.
MANUAL Manual (jog) mode.
EDIT EDISIMU mode.
MDI MDI/MDA mode.
TABLES User tables (zero offsets, fixtures and arithmetic parameters).
TOOLS Tool and magazine table.
UTILITIES Utilities mode.
CUSTOM Configurable mode.
OEM-configurable key that can carry out one of the following actions.

- Access a CNC work mode.
- Execute an application.
- Access the operating system.
- Carry out no function at all.









After accessing the work mode, these keys may be used to access the various screens of the active work mode sequentially, pressing [SHIFT] at the same time inverts the sequence.













CNC 8060
CNC 8065

(REF: 1402)









Keys to move the cursor.

-   The arrow keys move the cursor one position to the left, right, up or down.
-  
-   The previous-page or next-page keys show the previous or next page at the part-program or PLC program editor.
-   The home and end keys move the cursor the beginning or end of the line.
-  The tab key moves the cursor to the next field of the active menu.

Editing keys.

-  Shift.
Hold this key down to write upper case letters. When combining this key with a cursor moving key, it selects the text the cursor slides on.
-  Shift lock.
It toggles between uppercase and lowercase letters.
-  ASCII characters.
Hold this key down and key in the corresponding ASCII code.
-  Delete.
-  Delete.
-  Insert or overwrite.
-  Escape key, to cancel the current action without assuming the changes.
-  Key to validate commands, data and program blocks of the editor.
-  Recover data.
While the Teach-in mode is active, this key enters the axes and their current position into the block.
When selecting a profile or conversational canned cycle in the part-program, the key accesses either the profile editor or canned cycle editor accordingly.
-  Calculator.

Jog keyboard for jogging the axes.

-   Keys to select axes and jog them in the positive direction.
-   Keys to select axes and jog them in the negative direction.
-   Keys to select the axes and keys to select the jogging direction. Both keys (axis and direction) must be pressed to jog the axis.
-  
-  Rapid key. When pressing this key while moving an axis, the CNC applies the rapid feedrate.

Feed selectors.

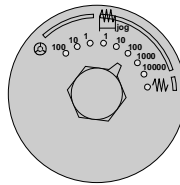

Sector for the type of jog; continuous / incremental jog or handwheels.



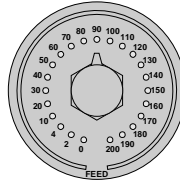

In handwheel mode, it selects the multiplying factor for the handwheel pulses (x1, x10 or x100).

In incremental mode, it selects the incremental value of the axis movements.







Selector of percentage of feedrate override, between 0% and 200%, for jog and automatic movements.



Execution keys.

-  Cycle start key (START).
Execute the selected program in automatic mode, a block in MDI/MDA mode, etc.
-  Cycle stop key (STOP).
Interrupt the execution of the CNC.
-  Reset key.
It initializes the system setting the initial conditions as defined by machine parameters.
-  Single-block execution mode.
When selecting the "single block" execution mode, the program simulation will be interrupted at the end of each block.
-  Home search.

Spindle control.

-  Start the spindle clockwise.
-  Stop the spindle.
-  Start the spindle counterclockwise.
-   To vary the spindle speed percentually.
-  Spindle orientation.

1.

DESCRIPTION OF THE KEYS
Monitor LCD-10K (option 2). (8065).



CNC 8060
CNC 8065

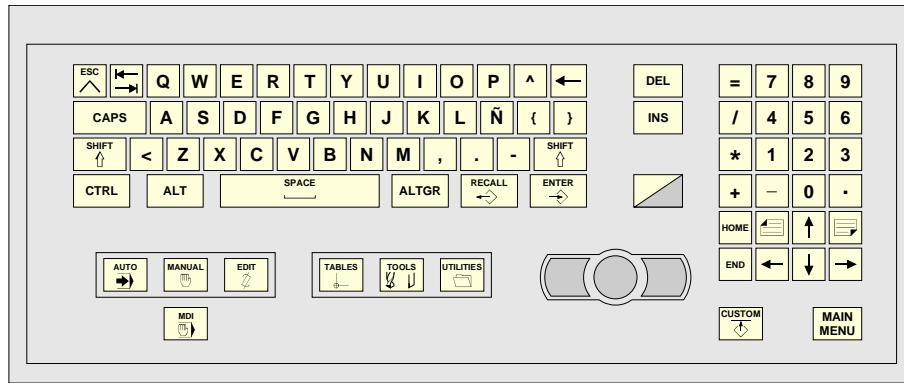

1.4 HORIZONTAL KEYB / HORIZONTAL KEYB + MOUSE. (8065).











1.

DESCRIPTION OF THE KEYS / HORIZONTAL KEYB + MOUSE. (8065).

Browsing keys.





-  Main menu.
-  Changing the state of an icon. In the MC/TC mode, it toggles between the standard and the auxiliary screens.

Work modes.











-  Automatic mode.
-  Manual (jog) mode.
-  EDISIMU mode.
-  MDI/MDA mode.
-  User tables (zero offsets, fixtures and arithmetic parameters).
-  Tool and magazine table.
-  Utilities mode.
-  Configurable mode.
OEM-configurable key that can carry out one of the following actions.
 - Access a CNC work mode.
 - Execute an application.
 - Access the operating system.
 - Carry out no function at all.

After accessing the work mode, these keys may be used to access the various screens of the active work mode sequentially, pressing [SHIFT] at the same time inverts the sequence.

Keys to move the cursor.

-  The arrow keys move the cursor one position to the left, right, up or down.
- 
-  The previous-page or next-page keys show the previous or next page at the part-program or PLC program editor.
-  The home and end keys move the cursor to the beginning or end of the line.
-  The tab key moves the cursor to the next field of the active menu.

Editing keys.

-  Shift.
Hold this key down to write upper case letters. When combining this key with a cursor moving key, it selects the text the cursor slides on.
-  Shift lock.
It toggles between uppercase and lowercase letters.
-  Alternate characters.
Hold this key down to access the alternate character set of the keyboard.
-  ASCII characters.
Hold this key down and key in the corresponding ASCII code.
-  Delete.
-  Delete.
-  Insert or overwrite.
-  Escape key, to cancel the current action without assuming the changes.
-  Key to validate commands, data and program blocks of the editor.
-  Recover data.
While the Teach-in mode is active, this key enters the axes and their current position into the block.
When selecting a profile or conversational canned cycle in the part-program, the key accesses either the profile editor or canned cycle editor accordingly.





CNC 8060
CNC 8065

(REF: 1402)

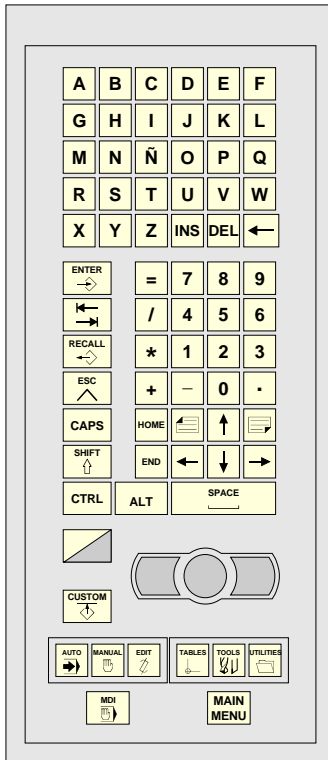







1.5 VERTICAL KEYB / VERTICAL KEYB + MOUSE. (8065).



Browsing keys.









-  Main menu.
-  Changing the state of an icon. In the MC/TC mode, it toggles between the standard and the auxiliary screens.

Work modes.









-  Automatic mode.
-  Manual (jog) mode.
-  EDISIMU mode.
-  MDI/MDA mode.
-  User tables (zero offsets, fixtures and arithmetic parameters).
-  Tool and magazine table.
-  Utilities mode.
-  Configurable mode.
OEM-configurable key that can carry out one of the following actions.
 - Access a CNC work mode.
 - Execute an application.
 - Access the operating system.
 - Carry out no function at all.

After accessing the work mode, these keys may be used to access the various screens of the active work mode sequentially, pressing [SHIFT] at the same time inverts the sequence.

Keys to move the cursor.

-   The arrow keys move the cursor one position to the left, right, up or down.
-  
-   The previous-page or next-page keys show the previous or next page at the part-program or PLC program editor.
-   The home and end keys move the cursor the beginning or end of the line.
-  The tab key moves the cursor to the next field of the active menu.

Editing keys.

-  Shift.
Hold this key down to write upper case letters. When combining this key with a cursor moving key, it selects the text the cursor slides on.
-  Shift lock.
It toggles between uppercase and lowercase letters.
-  ASCII characters.
Hold this key down and key in the corresponding ASCII code.
-  Delete.
-  Delete.
-  Insert or overwrite.
-  Escape key, to cancel the current action without assuming the changes.
-  Key to validate commands, data and program blocks of the editor.
-  Recover data.
While the Teach-in mode is active, this key enters the axes and their current position into the block.
When selecting a profile or conversational canned cycle in the part-program, the key accesses either the profile editor or canned cycle editor accordingly.



DESCRIPTION OF THE KEYS
VERTICAL KEYB / VERTICAL KEYB + MOUSE. (8065).



CNC 8060
CNC 8065

(REF: 1402)

1.6 HORIZONTAL KEYB. (8060).

1.

DESCRIPTION OF THE KEYS HORIZONTAL KEYB. (8060).

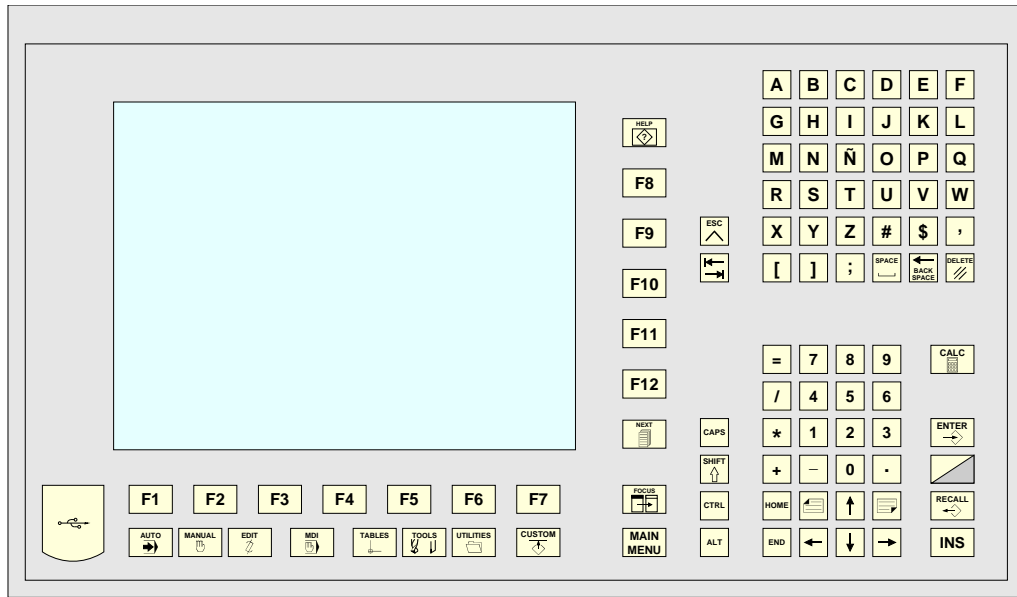

Function keys.

F1 Softkeys.
Keys F1 through F12 select the options of the softkey menus.

Browsing keys.

NEXT key.
Configurable key that can carry out one of the following actions.

- Access the various screens of the active work mode sequentially, pressing [SHIFT] at the same time inverts the sequence. In the PLC mode, it switches between the various active services.
- Sequentially access the different channels.
- The horizontal softkey menu shows the available screens and the vertical menu shows the available channels.

FOCUS key.
It is used to switch between the different windows of the screen.

Help key.

HELP key.
It accesses the CNC's system help.

Browsing keys.

MAIN MENU Main menu.
 Changing the state of an icon. In the MC/TC mode, it toggles between the standard and the auxiliary screens.

Work modes.

- AUTO** Automatic mode.
- MANUAL** Manual (jog) mode.
- EDIT** EDISIMU mode.
- MDI** MDI/MDA mode.
- TABLES** User tables (zero offsets, fixtures and arithmetic parameters).
- TOOLS** Tool and magazine table.
- UTILITIES** Utilities mode.
- CUSTOM** Configurable mode.
OEM-configurable key that can carry out one of the following actions.
 - Access a CNC work mode.
 - Execute an application.
 - Access the operating system.
 - Carry out no function at all.

After accessing the work mode, these keys may be used to access the various screens of the active work mode sequentially, pressing [SHIFT] at the same time inverts the sequence.

Keys to move the cursor.

- The arrow keys move the cursor one position to the left, right, up or down.
- The previous-page or next-page keys show the previous or next page at the part-program or PLC program editor.
- HOME** **END** The home and end keys move the cursor the beginning or end of the line.
- The tab key moves the cursor to the next field of the active menu.



CNC 8060
CNC 8065

(REF: 1402)

Editing keys.



Shift.
Hold this key down to write upper case letters. When combining this key with a cursor moving key, it selects the text the cursor slides on.



Shift lock.
It toggles between uppercase and lowercase letters.



ASCII characters.



Delete.



Delete.



Insert or overwrite.



Escape key, to cancel the current action without assuming the changes.



Key to validate commands, data and program blocks of the editor.



Recover data.
While the Teach-in mode is active, this key enters the axes and their current position into the block.
When selecting a profile or conversational canned cycle in the part-program, the key accesses either the profile editor or canned cycle editor accordingly.



Calculator.



DESCRIPTION OF THE KEYS
HORIZONTAL KEYB. (8060).



CNC 8060
CNC 8065

(REF: 1402)

1.7 VERTICAL KEYB. (8060).

1.

DESCRIPTION OF THE KEYS VERTICAL KEYB. (8060).

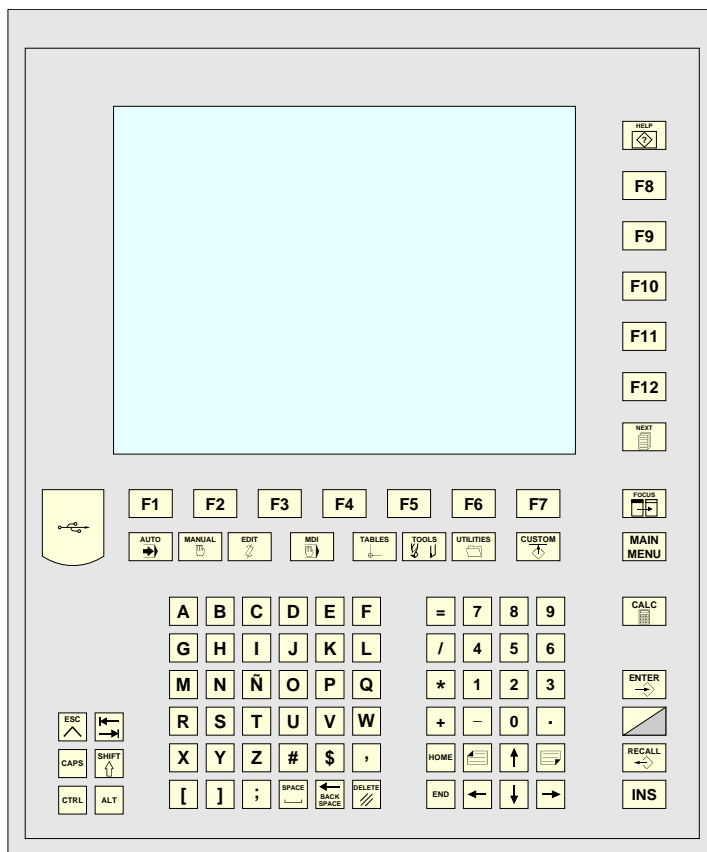

Function keys.

F1 Softkeys.
Keys F1 through F12 select the options of the softkey menus.

Browsing keys.

NEXT key.
Configurable key that can carry out one of the following actions.

- Access the various screens of the active work mode sequentially, pressing [SHIFT] at the same time inverts the sequence. In the PLC mode, it switches between the various active services.
- Sequentially access the different channels.
- The horizontal softkey menu shows the available screens and the vertical menu shows the available channels.

FOCUS key.
It is used to switch between the different windows of the screen.

Help key.

HELP key.
It accesses the CNC's system help.

Browsing keys.

MAIN MENU
Main menu.

Changing the state of an icon. In the MC/TC mode, it toggles between the standard and the auxiliary screens.

Work modes.

- AUTO** Automatic mode.
- MANUAL** Manual (jog) mode.
- EDIT** EDISIMU mode.
- MDI** MDI/MDA mode.
- TABLES** User tables (zero offsets, fixtures and arithmetic parameters).
- TOOLS** Tool and magazine table.
- UTILITIES** Utilities mode.
- CUSTOM** Configurable mode.
OEM-configurable key that can carry out one of the following actions.
 - Access a CNC work mode.
 - Execute an application.
 - Access the operating system.
 - Carry out no function at all.



After accessing the work mode, these keys may be used to access the various screens of the active work mode sequentially, pressing [SHIFT] at the same time inverts the sequence.









CNC 8060
CNC 8065

(REF: 1402)

Keys to move the cursor.

- 



The arrow keys move the cursor one position to the left, right, up or down.
- 

- 



The previous-page or next-page keys show the previous or next page at the part-program or PLC program editor.
- 



The home and end keys move the cursor the beginning or end of the line.
- 

The tab key moves the cursor to the next field of the active menu.

Editing keys.

- 

Shift.
Hold this key down to write upper case letters. When combining this key with a cursor moving key, it selects the text the cursor slides on.
- 

Shift lock.
It toggles between uppercase and lowercase letters.
- 

ASCII characters.
- 

Delete.
- 

Delete.
- 

Insert or overwrite.
- 

Escape key, to cancel the current action without assuming the changes.
- 

Key to validate commands, data and program blocks of the editor.
- 

Recover data.
While the Teach-in mode is active, this key enters the axes and their current position into the block.
When selecting a profile or conversational canned cycle in the part-program, the key accesses either the profile editor or canned cycle editor accordingly.
- 

Calculator.

1.

DESCRIPTION OF THE KEYS
VERTICAL KEYB. (8060).



CNC 8060
CNC 8065

(REF: 1402)

1.8 OP PANEL / OP PANEL + SPDL RATE. (8065).

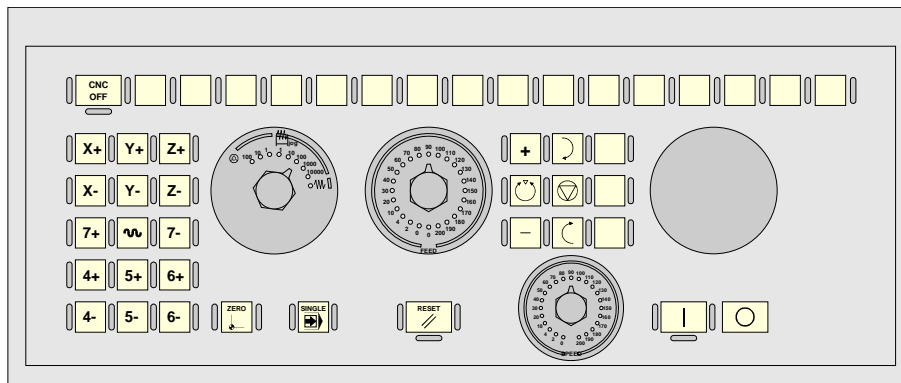

1.

DESCRIPTION OF THE KEYS
OP PANEL / OP PANEL + SPDL RATE. (8065).

Jog keyboard for jogging the axes.

- Keys to select axes and jog them in the positive direction.
- Keys to select axes and jog them in the negative direction.
- Keys to select the axes and keys to select the jogging direction. Both keys (axis and direction) must be pressed to jog the axis.
- Rapid key. When pressing this key while moving an axis, the CNC applies the rapid feedrate.

Feed selectors.

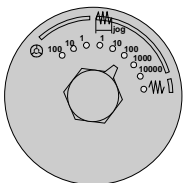

Sector for the type of jog; continuous / incremental jog or handwheels.

In handwheel mode, it selects the multiplying factor for the handwheel pulses (x1, x10 or x100).

In incremental mode, it selects the incremental value of the axis movements.

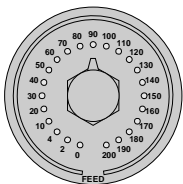

Selector of percentage of feedrate override, between 0% and 200%, for jog and automatic movements.

Execution keys.

- Cycle start key (START). Execute the selected program in automatic mode, a block in MDI/MDA mode, etc.
- Cycle stop key (STOP). Interrupt the execution of the CNC.
- Reset key. It initializes the system setting the initial conditions as defined by machine parameters.
- Single-block execution mode. When selecting the "single block" execution mode, the program simulation will be interrupted at the end of each block.
- Home search.

Spindle control.

- Start the spindle clockwise.
- Stop the spindle.
- Start the spindle counterclockwise.
- To vary the spindle speed percentually.
- Spindle orientation.

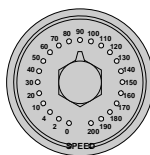

Selector of percentage of spindle speed override between 0% and 200%.

External devices.

The functions of these keys are defined by the machine manufacturer and they allow controlling the various devices of the machine (coolant, chip remover, etc.).



CNC 8060
CNC 8065

(REF: 1402)



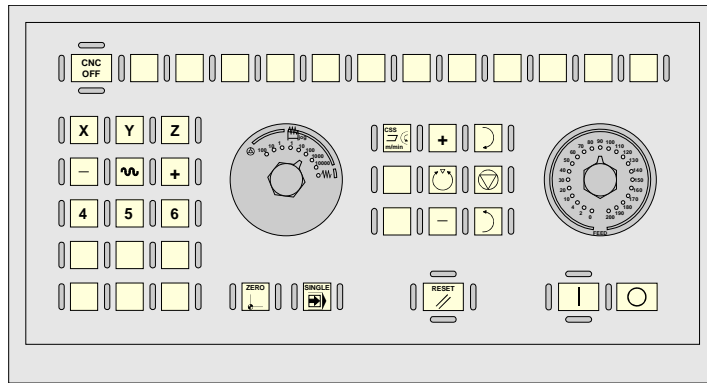





1.9 OP PANEL. (8060).









1.

DESCRIPTION OF THE KEYS
OP PANEL. (8060).

Jog keyboard for jogging the axes.

-   Keys to select axes and jog them in the positive direction.
-   Keys to select axes and jog them in the negative direction.
-   Keys to select the axes and keys to select the jogging direction. Both keys (axis and direction) must be pressed to jog the axis.
-   To vary the spindle speed percentually.
-  Rapid key. When pressing this key while moving an axis, the CNC applies the rapid feedrate.

Spindle control.

-  Start the spindle clockwise.
-  Stop the spindle.
-  Start the spindle counterclockwise.
-   To vary the spindle speed percentually.
-  Spindle orientation.
-  Constant Surface Speed (for lathe model only).

Feed selectors.

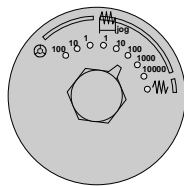

Sector for the type of jog; continuous / incremental jog or handwheels.

In handwheel mode, it selects the multiplying factor for the handwheel pulses (x1, x10 or x100).

In incremental mode, it selects the incremental value of the axis movements.

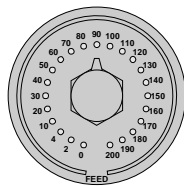





Selector of percentage of feedrate override, between 0% and 200%, for jog and automatic movements.

External devices.

The functions of these keys are defined by the machine manufacturer and they allow controlling the various devices of the machine (coolant, chip remover, etc.).

Execution keys.

-  Cycle start key (START).
Execute the selected program in automatic mode, a block in MDI/MDA mode, etc.
-  Cycle stop key (STOP).
Interrupt the execution of the CNC.
-  Reset key.
It initializes the system setting the initial conditions as defined by machine parameters.
-  Single-block execution mode.
When selecting the "single block" execution mode, the program simulation will be interrupted at the end of each block.
-  Home search.



CNC 8060
CNC 8065









(REF: 1402)





1.10 Keyboard shortcuts.





1.

DESCRIPTION OF THE KEYS
Keyboard shortcuts.

Operations at the interface.	
[CTRL] + [W]	Minimize/Maximize the CNC.
[CTRL] + [J]	Show / hide the virtual operator panel.
[CTRL] + [M]	Show / hide the PLC message list.
[CTRL] + [O]	Show / hide the CNC message list.
[ALT] + [W]	Show / hide the window for errors and warnings.
[ALT] + [F4]	Turn the CNC off.

Work modes.	
[CTRL] + [A]	To show the task window.
[CTRL] + [SHIFT] + [F1]	Main menu. 
[CTRL] + [F6]	Automatic mode. 
[CTRL] + [F7]	Manual (jog) mode. 
[CTRL] + [F9]	EDISIMU mode. 
[CTRL] + [F8]	MDI mode. 
[CTRL] + [F10]	User tables. 
[CTRL] + [F11]	Tool and magazine table. 
[CTRL] + [F12]	Utilities mode. 
[CTRL] + [K]	Calculator.

Browsing keys.	
[CTRL]+[F1]	Previous menu. 
[CTRL]+[F2]	Switch window. 
[CTRL]+[F3]	Switch screens. 
[ALT]+[B]	Two-color key. 

Execution keys.	
[CTRL]+[S]	Cycle start key (START). 
[CTRL]+[P]	Cycle stop key (STOP). 
[CTRL]+[R]	Reset key. 
[CTRL]+[B]	Single-block execution mode. 

The shortcuts for the [START] [STOP] and [RESET] keys are only available when the CNC is installed as simulator on a PC.

Program editor	
[CTRL]+[C]	Copy the selected text.
[CTRL]+[X]	Cut the selected text.
[CTRL]+[V]	Paste the selected text.
[CTRL]+[Z]	Undo the last change.
[CTRL]+[Y]	Redo the selected text.
[CTRL]+[G]	Save the program / Recover the original program.
[CTRL]+[+]	Zoom in.
[CTRL]+[-]	Zoom out.
[ALT]+[-]	Hide or expand a cycle.
[CTRL]+[HOME]	Move the cursor to the beginning of the program.
[CTRL]+[END]	Move the program to the end of the program.
[CTRL]+[TAB]	Toggle between the editor and the error window.
[CTRL]+[F5] [RECALL] key.	



CNC 8060
CNC 8065

(REF: 1402)

2.1 Turning the CNC on and off

The way the CNC is turned on and off depends on the disk installed (read-only disk or not) and on how it has been set by the machine manufacturer. However, the most common way to do it is as follows.

Turning the CNC on

After powering up the unit, the operating system (Windows XP) will start up first. Then, and depending on how the manufacturer has set it, the CNC application will either start up automatically or will have to be initiated by clicking on the icon shown on the screen.

While starting up, it will display the initial standard CNC screen or the initial screen created by the machine manufacturer for that purpose. Once the CNC is running, it will show the screen for the work mode (automatic or jog) selected by the machine manufacturer.

Messages and options during the start-up.

When powering the CNC up, it informs on the contingencies that may be interesting. Depending on what the CNC checks on power-up, the CNC shows, if necessary, the option to "Restore backup copy and continue". This option shows the available backup copies and, once it is selected, the CNC will rename the current MTB folder and will restore the one in the selected backup copy. If the data bases are not valid, the CNC updates them.

When restoring a backup copy or the data bases while the CNC is in user mode, the CNC shows a message indicating that the change is temporary. These two situations occur because in both cases, the CNC modifies files that are write-protected in user mode. To make these change permanent, start the CNC up in setup mode.

Keeping the [END] key pressed while starting the CNC up cancels that process and the CNC shows the options to resume the start-up, cancel the start-up or restore a backup copy.

Peculiarities of a write-protected (read-only) disk.

The CNC application will only start up when the unit is in one of the following work modes; the CNC application does not start up in administrator mode.

- Setup mode.

This mode must only be used to update the CNC software and to set up the machine. The access to this mode is protected with the password "machine parameters", defined in the utilities mode. On power-up, the CNC shows a warning indicating that the disk is unprotected.

- User mode.

It is the usual work mode for the user, once the setup is completed. The manufacturer must deliver this unit to the user set up to start up in this mode. The access to this mode is not protected with the password.

Turning the CNC off.

To turn the CNC off, press the key combination [ALT]+[F4]. The CNC must not be turned off if there is any program in execution.

After closing the CNC application and depending on how the manufacturer has set it, the unit will turn off automatically or it will be required to select *Shut down the system* option of

the *Start* menu. Once the application is closed, the screen will show a message indicating to the operator that the unit may then be turned off.



The unit must be turned off with the on/off switch after having closed the application using the key combination mentioned earlier. Turning the unit off incorrectly may cause the loss of information about:

- *Active offsets (zero offsets, part offset, etc.).*
- *Coordinates.*
- *Parts counter.*
- *Active axis sets.*
- *Information about the next tool.*

If on power-up, it displays the error " 12 - Checksum error in CNC data", it means that the CNC has been turned incorrectly (due to a power failure, etc.) and consequently that information has been lost: When this error message is displayed, home (reference) the axes again and activate the offsets (part zero included) and the sets of axes.

Make a backup copy at a CNC with a disk that is not write-protected (not read-only).

If when turning the CNC off or resetting it, it detects a configuration change, the CNC will show the option to make a backup copy of the new configuration (MTB folder). The backup copies are saved in the "\Backup" folder in a compressed format.

Make a backup copy at a CNC with a disk that is write-protected (read-only).

- Setup mode.

If the CNC is started up in setup mode, it offers the option to save a backup copy. Once setup is completed, it is recommended to make a backup copy of the configuration; if there is none, the CNC will make one automatically.

Every time the CNC is turned off, it asks if the setup is completed.. If setup is not completed. it will continue in setup mode the next time the system is restarted. If setup is completed, the CNC makes a backup copy if necessary and it will work in user mode the next time the system is restarted. The CNC makes a backup copy when there are changes in the machine parameters, in the PLC program or in the OEM subroutines.

- User mode.

If the CNC is started up in user mode, it does not offer the option to save a backup copy. The manufacturer must have saved the backup copy of the configuration during the setup. The backup copies are saved in the "\Backup" folder in a compressed format.

2.

GENERAL CONCEPTS
Turning the CNC on and off



CNC 8060
CNC 8065

(REF: 1402)

2.1.1 Emergency shutdown with battery (8065 only).

The central unit is powered by an external DC power supply (24 V DC). Optionally, an external battery may be connected to ensure the detection of power supply voltage drops and that the unit is turned off properly.

When a power supply failure occurs (drop at the 24 V DC) and there is a battery connected to the central unit, the latter responds as follows:

- If the supply is interrupted for less than 2 seconds.

The screens shows the corresponding warning and the system recovers fine. CAN errors may occur due to the lack of 24 V DC at the remote modules.

- If the supply is interrupted for more than 2 seconds.

After the 2 seconds, the screen shows the corresponding error and it initiates the automatic turn-off sequence. First, it stops the machine if it is in execution. It closes the CNC application, then the whole system and finally turns the battery off.

2.

GENERAL CONCEPTS
Turning the CNC on and off

FAGOR 

CNC 8060
CNC 8065

(REF: 1402)

2.2 Work modes and software protection at the CNC.

Fagor delivers the unit with a protected compact flash type disk that is write-protected except for the folders or files that must be unprotected for the normal operation of the CNC. The changes made to protected folders or files will be operative until the unit is turned off and back on, the CNC will then restore the initial configuration. The changes made to unprotected areas of the disk will remain.

The disk has been pre-configured with three access modes, each offers a different protection level. The unit shows the active work mode with an icon on the task bar of the operating system, next to the clock. When the CNC is turned on, the status bar shows the active work mode with icons.

Icon.	Work mode.
	Administrator mode.
	Setup mode.
	User mode.



These work modes will not be available when upgrading the software from a version where the unit has a disk that is not write-protected (not read-only). Since it is not write-protected, the changes made to it will remain.

Work mode change (diskMonitor window).

- Having the CNC application turned off, the work mode change is done using the [ALT][D] or with icon indicating the active work mode, on the task bar of the operative system (next to the clock). In either case, the unit shows the DiskMonitor window to switch from one work mode to another. This process implies restarting the unit and if the manufacturer has set it up this way, it will also be necessary to enter the corresponding password.
- Having the CNC started up in any work mode, the [ALT][D] hotkey shows the DiskMonitor window to change from one work mode to another. This process implies restarting the unit and if the manufacturer has set it up this way, it will also be necessary to enter the corresponding password.
- The desired work mode may be selected from the utilities mode, from the softkey menu. This process implies restarting the unit and if the manufacturer has set it up this way, it will also be necessary to enter the corresponding password.

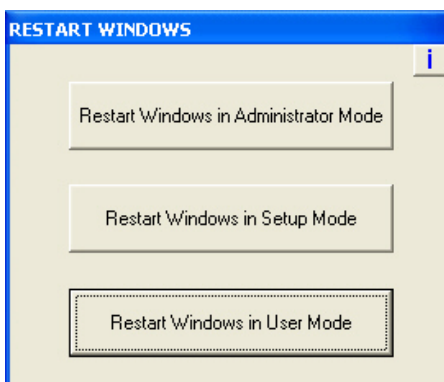

CNC 8060
CNC 8065

(REF: 1402)

Protecting or unprotecting the folders.

In the previous window, when selecting the -i- at the top right hand side, the unit shows the list of folders and files that are unprotected at the time. In administrator mode and the list of folders being visible, pressing [CTRL]+[ALT]+[TAB]+[SHIFT] it is possible to protect or unprotect any folder or file of the system that is not key for the proper operation of the CNC.

Administrator mode.

The access to the administrator mode is enabled with the validation code ("Open system" software option). If you don't have this software option, (i.e. you have a "closed system") you will not be able to access the administrator mode and, therefore, you will not be able to install third-party software.



This mode must only be used to install non-Fagor software, to install the CNC (also possible from the setup mode), to update the operative system or change the system configuration. The CNC application does not start up in this mode.



The unit shows the following image on the desk, with red background, indicating the active work mode and warning that it is not a protected mode.

Protection level.

There is not protection level in administrator mode, the whole disk is unprotected.

Protection password.

The access to this mode is protected with the password "administrator mode", defined in the utilities mode. When starting the unit up in this work mode, it will request the access password.

Setup mode.



The setup mode must only be used to update the CNC software and to set up the machine; it does not allow installing third-party software. This mode may be used to access the operative system.



The unit shows the following image on the desk, with yellow background, indicating the active work mode and warning that it is not a protected mode.

Protection level.

The setup mode has an intermediate protection level where everything that may be changed while setting the machine up is unprotected; folders ..\MTB, ..\USERS, ..\DIAGNOSIS and the Windows register.

Protection password.

The access to this mode is protected with the password "machine parameters", defined in the utilities mode. When starting the unit up in this work mode, it will request the access password.

2.

GENERAL CONCEPTS

Work modes and software protection at the CNC.

FAGOR 

CNC 8060
CNC 8065

(REF: 1402)

User mode.



It is the usual work mode for the user, once the setup is completed. This mode does not allow updating the CNC or accessing the operative system. Some utilities of the operative system (task manager, clock) will be available from the diagnosis mode.

Part-programs must be saved in the "..\USERS" folder; the CNC considers the files saved in other folders as temporary files and will be deleted when the CNC is turned off. Files from flash, pendrives, ethernet, etc. can only be managed from the explorer of the utilities mode.

Protection level.

The user mode has the maximum protection level where only the folders and files that may be changed during the normal operation of the machine are unprotected.

Protection password.

The access to this mode is not protected with the password.

Restrictions for working in Setup mode and switching to User mode.

The purpose of the following restrictions is for the OEM to deliver his machines with the CNC in protected work mode (User mode).

SETUP mode

On power-up, the CNC will show a message indicating that it is in an unprotected mode and that the setup has not been completed yet. In this situation, the CNC is no longer under Fagor warranty. After a certain period of time, with the next reset, the CNC shows the message again.

When closing the application, the CNC asks if the setup is completed..

- If YES is selected and there are passwords, the CNC makes a backup copy and switches over to USER mode (process OK).
- If YES is selected and there are no passwords, the CNC issues a warning message and does not close the application.

USER mode (work mode).

On power-up, the CNC checks for passwords and a backup copy. If any of these two is missing, the CNC will show a message indicating that setup has not been completed yet. In this situation, the CNC is no longer under Fagor warranty. The CNC checks this at every reset.

This situation can be reached when accessing the USER mode from SETUP mode through "DiskMonitor".

2.

GENERAL CONCEPTS
Work modes and software protection at the CNC.



CNC 8060
CNC 8065

(REF: 1402)

2.3 Ethernet.

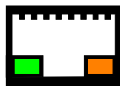

Ethernet support for the following features, through the connector of the central unit.

- Point-to-point connection.
- Microsoft company networks.
- Internet for telediagnosis.
- TeamViewer server.

The CNC must be configured as any node of the network as if it were a regular PC. The following actions are possible when having a CNC configured as a node within the computer network:

- Access from any PC to the part-program directory of the CNC.
- Access from the CNC to any PC, to execute, simulate or edit programs. The program to be executed needs not be in the local disk.
- Copy programs and tables from the CNC to a PC and vice versa.
- Edit, modify, delete, rename, etc. the programs stored at the CNC.
- Perform a telediagnosis of the CNC.

2.4 USB.



USB support for the following devices.

- Pendrive.
- Keyboard and mouse.



DO NOT connect any kind of hub to the USB port.

2.

GENERAL CONCEPTS
Ethernet.

FAGOR 

CNC 8060
CNC 8065

(REF: 1402)

2.

GENERAL CONCEPTS
USB.



CNC 8060
CNC 8065

(REF: 1402)

3.1 General description of the interface.

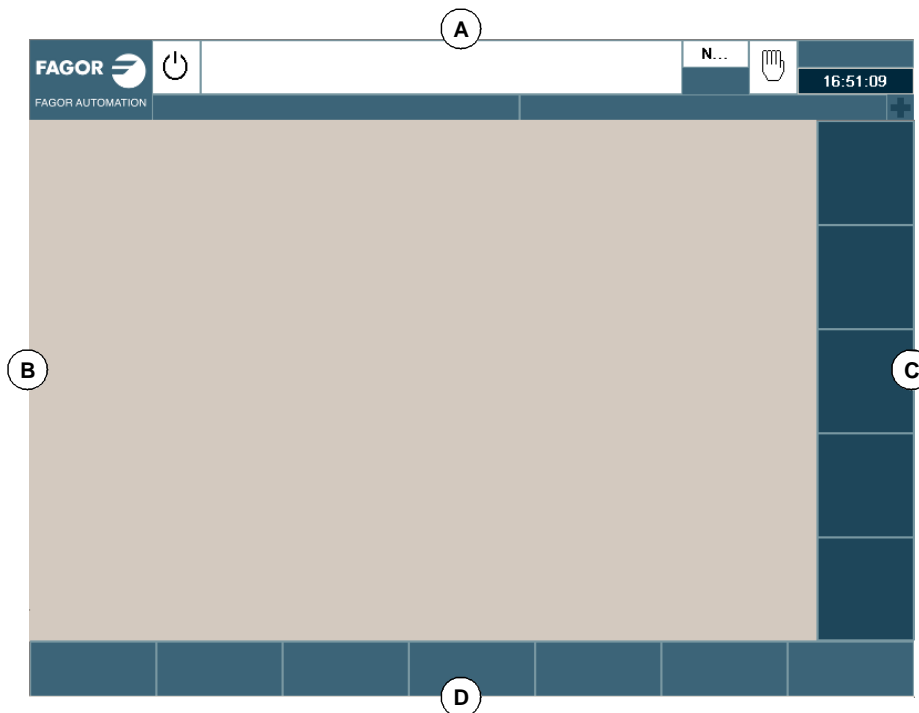

A General CNC-status bar.

This area shows the information on the program being executed, the active operating mode, the PLC messages, etc. See "[Detailed description of the CNC status bar](#)" on page 52.

B Windows of the active work mode.

The information shown in this area depends on the active work mode (automatic, jog, etc.). The information shown in each work mode is described in the relevant chapter.

C Vertical softkey menu.

The menu options change depending on the active work mode. The different options are selected using softkeys F8 through F12.

This menu may appear to the left or right of the interface depending on how the OEM has configured the machine.

D Horizontal softkey menu.

The menu options change depending on the active work mode. The different options are selected using softkeys F1 through F7.

3.2 Detailed description of the CNC status bar

The status bar of the CNC (top of the screen) shows the following information.

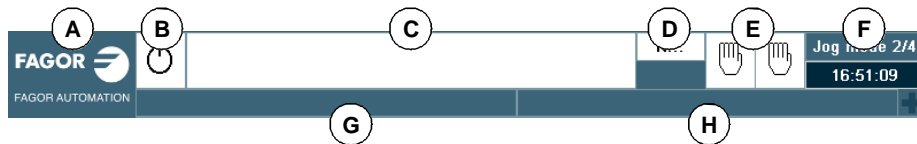

A Icon (customizable) identifying the manufacturer.

Clicking with the mouse or pressing on a touch-screen, the CNC shows the task window (same as pressing the keystroke sequence [CTRL]+[A]) that shows the list of the work modes and hotkeys of the CNC.

B Icon showing the status of the program of the active channel: The background color will be different depending on the status of the program.

Icon.	Meaning.
	Programmed stopped. Background color: White.
	Program in execution. Background color: Green.
	Program interrupted. Background color: Dark green.
	Program in error. Background color: Red.

C Program selected in the active channel for execution.

Clicking with the mouse or pressing a touch-screen has the same effect as the [Main-Menu] key, which shows the initial screen of the CNC.

D Number of the block in execution. The bottom icon indicates that the Single-block execution mode is active.

E Information about the channels. Number of channels available and active channel (indicated in blue). Icons show which operating mode each channel is in. The channel synchronization window may be expanded using the [ALT]+[S] keys.

Clicking with the mouse or pressing a touch-screen to access the desired channel, doing it on the icon of the active channel, has the same effect as the [ESC] key.

Icon.	Meaning.
	Execution mode.
	Jog mode.
	MDI/MDA mode.

F Active work mode (automatic, manual, etc.) selected screen number and total number of screens available. System clock.

By clicking on the active work mode, the CNC shows the list of available pages and which ones are visible.

G Active CNC message.

For each channel, it shows the last message activated by the program that is running. The window shows the last message of the active channel. If there are messages in other channels, it will highlight the "+" sign next to the message window. To display the list of active messages, press the key combination [CTRL]+[O] or click on the CNC message line.

The list of messages shows, next to each message, the channel where it is active.

H PLC messages.

3.

HOW TO OPERATE THE CNC
Detailed description of the CNC status bar



CNC 8060
CNC 8065

(REF: 1402)

3.2.1 Channel synchronization window

The channel synchronization window is available in all work modes. This window may be expanded using the key combination [ALT]+[S]. The synchronization is carried out using marks in the programs. The window shows for each channel whether it is waiting for synchronization marks or not and the status of those marks in the channel that originates them.

The different color LED's of the window show the status of the synchronization marks of each channel. On the left, the channels waiting for the marks and on top the channels that originate them.

LED.	Meaning.
White	The channel is not expecting any synchronism mark.
Green	The channel is expecting a synchronism mark. The mark is active (set to ·1·) in the channel that originates it.
Red	The channel is expecting a synchronism mark. The mark is not active (set to ·0·) in the channel that originates it.

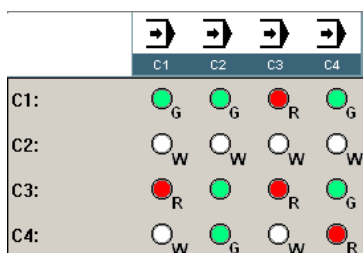

Channel 1 (CH1) is expecting synchronism marks from the rest of the channels. The marks of channels 2 and 4 are active. The mark of channel 3 is not active.

Channel 2 is not expecting any synchronism mark.

(In the graphic, the white LED's are identified with the letter -W-, the green ones with the letter -G- and the red ones with the letter -R-).

3.

HOW TO OPERATE THE CNC

Detailed description of the CNC status bar



CNC 8060
CNC 8065

(REF: 1402)

3.2.2 PLC messages.

When the PLC activates a message, the CNC shows on the general status bar (lower right) the message number and its associated text. If the message has been defined so it shows a file with additional information, it will be displayed at full screen (if the file does not exist, a blue screen will be displayed).



If there are several active messages, it will display the one with highest priority (the one with lowest number). It will also show the "+" sign next to the PLC message window to indicate that there are more messages activated by the PLC. To display the list of active messages, press the key combination [CTRL]+[M] or click on the PLC message line.

List of active PLC messages.

On the message list and next to each message, a symbol will appear to indicate whether the message has an additional information file associated with it or not. To display a message, select it with the cursor and press [ENTER]. If the message has an additional information file, it will be displayed on the screen. To close the additional information window, press [ESC].

Icon.	Meaning.
	The message does not have a file with additional information.
	The message has a file with additional information.

File with additional information

The files with additional information, defined by the machine manufacturer, may be displayed automatically when activating the message (if so defined in the table for messages and errors) or when requested by the user (at the message window). The following keys are available to move around in the additional information window depending on the type of file displayed (TXT, BMP, JPG, HTM, HTML or AVI):

TXT, BMP, JPG, HTM, HTML file.

Key.	Meaning.
	Scroll the window line by line.
	Scroll the window page by page.
	Take the window to the beginning or to the end.

AVI file.

Key.	Meaning.
	Stop the video and move to next frame or previous frame.
	Stop the video and move to the next 5 frames or to the previous 5 frames.
	Stop the video and move to the end or to the beginning.
	Stop the video.
	Play the video.

3.

HOW TO OPERATE THE CNC
Detailed description of the CNC status bar



CNC 8060
CNC 8065

(REF: 1402)

3.3 Horizontal softkey menu

Softkey tree based on popup menus so there is only one softkey level.



The softkey menu expands and shrinks with keys [F1] through [F7]. The softkey of the pop-up menu are selected with the [ENTER] key or from the numeric keypad using the number that comes with each softkey.

3.

HOW TO OPERATE THE CNC
Horizontal softkey menu



CNC 8060
CNC 8065

(REF: 1402)

3.4 Operating modes

Access to the operating modes.

The CNC operating modes may be accessed from the keyboard or from the task window. To open the task window, use the key combination [CTRL]+[A] or click (or press on a touch-screen) on the OEM icon (left of the status bar).



From the task window, it is possible to access all the operating modes of the CNC, whereas from the keyboard it is only possible to access the specific operating modes of the OEM (PLC, machine parameters, etc.). When this operating mode is active, it will be indicated at the top right side of the general status bar.

Operating modes accessible from the keyboard.

Key.	Operation mode.
	Automatic mode.
	Jog mode.
	EDISIMU mode (editing and simulation).
	MDI/MDA mode.
	User tables (zero offsets, fixtures and arithmetic parameters).
	Tool and magazine table.
	Utilities mode.
	Configurable mode. OEM-configurable key that can access to one of the following operating modes. <ul style="list-style-type: none"> • Machine parameters. • PLC. • Diagnosis mode. • Setup assistance.

The [CUSTOM] key, depending on how the OEM has configured it, can also execute an application (FGUIM), access the operating system or not carry any action out.

Screens or pages the make up the work modes.

Each operating mode may consist of several screens or pages. The current screen or page and the total number of available screens are shown at the upper right hand side of the general status bar.



The exchange between the different screens of an operating mode is done using the key to access that operating mode or with the [NEXT] key (if the OEM has configured it that way). When pressing one of these keys, the CNC will show the next screen and when pressing them together with the [SHIFT] key, it will show the previous screen. The screen selection is rotary in such a way that when pressing this key on the last screen, it shows the first one.

By clicking on the active work mode, the CNC shows the list of available pages and which ones are visible.

3.

HOW TO OPERATE THE CNC
Operating modes



CNC 8060
CNC 8065

(REF: 1402)

Work modes and channels.

A multi-channel CNC system may have up to four channels; each of which constitutes a different work environment that may act upon part of the CNC system or on the whole CNC system. Some operating modes are specific for each channel whereas others are common to all the channels (unique for the whole CNC).

The specific operating modes for each channel act independently from the rest of the channels; for example, the automatic mode can execute a different program in each channel. The common operating modes act on the whole CNC, affect all the channels; for example, the PLC is common to the whole CNC.

Operation mode.	Relationship with the channel.
Automatic mode	The automatic mode is specific for each channel.
Manual (jog) mode	The jog mode is specific for each channel.
MDI/MDA mode	The MDI mode is specific for each channel.
EDISIMU mode (editing and simulation)	The EDISIMU mode is specific for each channel.
User tables	These tables are common to all the channels.
Tool table Magazine table	These tables are common to all the channels.
Utilities mode	The utilities mode is common to all the channels.
PLC	The PLC mode is common to all the channels.
Machine parameters	The machine parameters are common to all the channels.
Tuning mode (Setup assistance).	The tuning mode is common to all the channels.

3.

HOW TO OPERATE THE CNC
Operating modes



CNC 8060
CNC 8065

(REF: 1402)

3.4.1 Description of the various operating modes

The CNC offers the following operating modes.

Operation mode.	Operations allowed.
Automatic mode	<ul style="list-style-type: none"> • Display the data regarding axis position, "M" and "G" function history, active tool, spindle speed, axis feedrate, etc. • Execute a part-program in "single block" or "automatic" mode. • Set the execution conditions (first and last blocks) before executing the program. • Searching a block. Recover the history of a program up to a particular block, with the option to change the active F, S, M and H functions and resume program execution from that block. • Show a graphic representation of the program being executed. • Perform a tool inspection while executing the program.
Manual (jog) mode	<ul style="list-style-type: none"> • Display the data regarding axis position, "M" and "G" function history, active tool, spindle speed, axis feedrate, etc. • Home the axes (Machine reference zero search). • Jog the axes with the handwheels or with the JOG keys. • Move an axis to a position by previously selecting the target point. • Preset a coordinate. • Act upon the master spindle using the Jog keyboard. • Change tools. • Activate external devices of the machine using the keys of the upper side of the operator panel. The external devices associated with each key must be defined by the machine manufacturer. • Calibrate a tool in jog mode (without probe), in semi-automatic mode (when using a table-top probe) or using the tool calibration cycle (also when using a table-top probe). • Part centering (mill model). • Turn the CNC off from the softkey menu.
MDI/MDA mode	<ul style="list-style-type: none"> • Edit and execute individual program blocks. • Save the set of blocks executed as an independent program.
EDISIMU mode (editing and simulation)	<ul style="list-style-type: none"> • Edit, modify or view the contents of a part-program. • Simulate the execution of a program displaying a graphic representation of the program being simulated. • Estimate the total program execution time and the machining time for each tool. • Syntax test of the program.
User tables	<ul style="list-style-type: none"> • Edit and modify the tables for zero offsets, fixtures and arithmetic parameters. • Save the content of a table. • Recover the content of a table. • Print the content of a table.
Tool table Magazine table	<ul style="list-style-type: none"> • Editing and modifying the tool table • Editing and modifying the tool magazine table. Display and manage the tool arrangement in the magazines and in the tool changing arms (if any). • Display the information about the tool change process; the operation carried out when executing an M06, manager status, change status (in execution or at rest), magazine involved in the change (if the change is taking place) and whether the change process is or not in an error state. • Load and unload a tool from the magazines through the spindle, using a maneuver. • Saving the table contents. • Recalling the table contents. • Printing the table contents.

3.

HOW TO OPERATE THE CNC

Operating modes



CNC 8060
CNC 8065

(REF: 1402)

Operation mode.	Operations allowed.
Utilities mode	<ul style="list-style-type: none"> • See the files stored at the CNC, in a peripheral device or at another CNC (or PC) connected via Ethernet. • Create new folders to save files. • Select a file group and carry out operations such as copy, rename or delete files. • Change file attributes. • Do a file search based on a text already defined in them. • Set a password to restrict the access to the customizing tool FGUIM, to machine parameters and to the PLC. • Make or restore a backup copy of the CNC data.
PLC	In this operating mode, the PLC may be accessed to check its operation or the status of the different PLC variables. It is also possible to edit and analyze the PLC program as well as the message and error files of the PLC.
Machine parameters	<ul style="list-style-type: none"> • Edit and modify the machine parameter tables. • Validate the machine parameter tables. • Saving and restoring the table contents. • Printing the table contents. <p>The machine parameter tables may be edited in this mode or be copied from a floppy disk or other peripheral connected to the CNC via Ethernet.</p>
Tuning mode (Setup assistance)	<p>The set of utilities of the setup assistance is meant to speed up and simplify the machine setup procedure. The setup assistance offers the following utilities.</p> <ul style="list-style-type: none"> • The oscilloscope. • The circularity (roundness) test. • The bode diagram. <p>It must be borne in mind that these utilities are assistance tools that only show the system's response to the various adjustments; it is always up to the technician to choose the best adjustment.</p>
DDSSetup mode	<ul style="list-style-type: none"> • See the list of devices connected to the servo bus. • Change the access level for the parameters of Sercos drives. • Edit the parameters and variables of Sercos drives. • Edit the parameters of Mechatrolink servos. • Display the list of active errors at the drive. • Monitor in real time the value of the drive variables. • View the status of the operation being carried out at the drive and the status of the digital inputs and outputs of the drives. • Configure and start up the internal command generator of the Sercos drives.
Diagnosis mode	<ul style="list-style-type: none"> • Test the hardware and software of the PC that the CNC is based upon. • Show system information. • Show information about the modules that make up the CNC software. • Show information about the elements connected to the CNC through the CAN bus, Sercos or Mechatrolink. <p>The diagnosis is a testing and displaying tool; it cannot be used to modify the displayed values.</p>

3.

HOW TO OPERATE THE CNC Operating modes



CNC 8060
CNC 8065

(REF: 1402)

3.5 Task window

The task window shows the list of all the operating modes of the CNC and the list of available hotkeys. To open the task window, use the key combination [CTRL]+[A] or click (or press on a touch-screen) on the OEM icon (top left of the screen). Press [ESC] to close the window without making a selection.

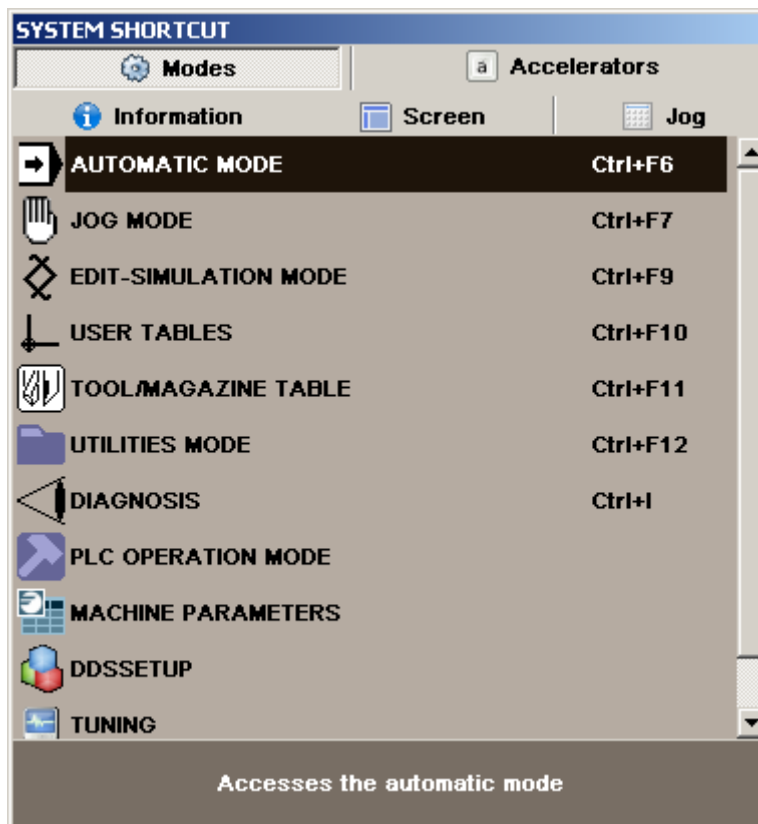

Moving around in the task window

Besides the mouse, the following keys may be used.

- | | |
|--------------|--------------------------------------|
| [↑] [↓] | Moves the cursor through the window. |
| [CTRL]+[TAB] | Changes the panel. |
| [ENTER] | It accesses the selected mode. |



CNC 8060
CNC 8065

(REF: 1402)

3.6 Windows for warnings and errors

3.6.1 CNC warnings and errors

When an error occurs, the CNC displays a window with the error category, its number and its associated text. There are three error categories, each one of them shows a window in a different color.

WARNING	Green window.
ERROR	Red window.
FATAL ERROR	Purple window.

When several warnings and/or errors occur simultaneously, they are displayed from the one with the highest priority to the one with the lowest priority. A down arrow indicates that there are errors or warnings with lower priority and an up arrow indicates that there are some with higher priority. The order of priority appears next to the arrows. The operator can toggle the different active errors or messages using the [↑][↓] keys.

The warning and error windows may be displayed or hidden with the keystroke combination [ALT]+[W] or clicking on the windows and on the status bar. When these windows are hidden, the status bar will show an indicator with the active error number. If several errors are active, it will highlight the "+" sign next to the number.

Help for the warnings and errors.



Some warning and errors, besides their description, can show additional information on their causes and solutions. If the warning or error offers this option, a help icon will appear to the right of its number. This additional information may be displayed by pressing the [HELP] key or clicking on the help icon. To close the window for warnings and errors, press [ESC].

WARNING

The system warning messages are just warnings, they do not interrupt the execution of the part-program and may be eliminated by pressing the [ESC] key.

The warnings programmed with the instruction #WARNINGSTOP interrupt the execution of the program at the point where this instruction has been programmed. In this type of warnings, it's up to the user to either resume the execution at this point, [START] key, or abort the program, [RESET] key.

ERROR

It may be a syntax error in a program, PLC generated errors, etc. These errors interrupt the execution of the program and they must be corrected.

While the error window is active, no other action will be possible but removing it (it is not possible to change operating modes in the channel). Some errors may be eliminated by pressing the [ESC] key, whereas for others, the [ESC] key only closes the window that shows it and the [RESET] key must be pressed to eliminate the error state. After pressing [RESET] the CNC assumes the initial conditions set by the machine manufacturer with the machine parameters.

The [RESET] key is needed to eliminate the errors that open the emergency relay, errors occurred in execution, loop errors, bus errors, PLC errors, hardware errors, etc.

FATAL ERROR

They are errors that force the operator to turn the CNC off. If the error persists, contact the Service Department at Fagor Automation.

3.

HOW TO OPERATE THE CNC
Windows for warnings and errors

FAGOR 

CNC 8060
CNC 8065

(REF: 1402)

3.6.2 PLC errors.

When the PLC activates an error, the CNC interrupts the execution of the part-program and the center of the screen displays a window with the error number and its associated text. If the error has been defined so it shows a file with additional information, it will be displayed at full screen. If the error has the "Emergen" field selected, the error will open the emergency relay of the CNC.

Error window.





If the error has a file with additional information associated with it, an access icon will appear to the right of the error number. If the error has the "Show" field selected, the CNC shows the additional information file directly on the screen. If the "Show" field is not selected, the additional information file will be displayed when pressing the [HELP] key or when clicking on the icon mentioned earlier. To close the additional data window, press [ESC].

When there is an active error, no other action but eliminating the error state is allowed. Although the window displaying the errors may be closed by pressing [ESC], it does not mean that the error status has been taken care of. To do that, press [RESET]. Pressing the [RESET] key assumes the initial conditions.





File with additional information

The files with additional information, defined by the machine manufacturer, may be displayed automatically when activating the message (if so defined in the table for messages and errors) or when requested by the user (at the message window). The following keys are available to move around in the additional information window depending on the type of file displayed (TXT, BMP, JPG, HTM, HTML or AVI):

TXT, BMP, JPG, HTM, HTML file.

Key.	Meaning.
	Scroll the window line by line.
	Scroll the window page by page.
	Take the window to the beginning or to the end.

AVI file.

Key.	Meaning.
	Stop the video and move to next frame or previous frame.
	Stop the video and move to the next 5 frames or to the previous 5 frames.
	Stop the video and move to the end or to the beginning.
	Stop the video.
	Play the video.

3.

HOW TO OPERATE THE CNC
Windows for warnings and errors



CNC 8060
CNC 8065

(REF: 1402)

3.7 File selection window

The file selection window is common to all operating modes. This window is displayed when, from an operating mode, the operator selects the option to open, save or import a file, open or load a table, etc.

From this window, it is possible to either select an existing file or create a new one. A new file may be created only when it is a valid action. Depending on the operating mode it is accessed from, the list will only show the proper files.

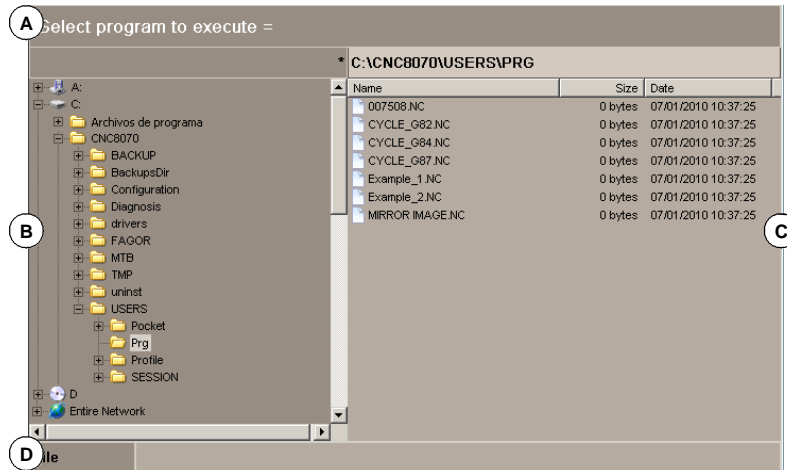

- A Type of file and operation to carry out (open, save, etc.).
- B Folder tree.
- C Files contained in the selected folder.
- D Area to define the name of the new files. A file can also be selected when knowing its name.

Move around in the window

Besides the mouse, the following keys may be used.

Key.	Meaning.
	It switches the window focus.
	With the focus on a folder, it closes and opens the submenu of folders.
	To move the focus through the elements of the window.
	To move the focus page by page.
	To move the focus to the beginning or end of the list.
	Opens the selected file.
	To cancel the selection and close the program listing.

Creating a new file

To create a new file:

- 1 Select the destination folder for the file.
- 2 Write the file name at the bottom window.
- 3 Press [ENTER] to confirm the action.

Pressing [ESC] cancels the operation at any time and closes the window.

3.

HOW TO OPERATE THE CNC
File selection window



CNC 8060
CNC 8065

(REF: 1402)

To select a file from the list

A file may be selected from the list:

- 1 Select the folder that contains the program.
- 2 Select the file from the list or write its name in the bottom window.
- 3 Press [ENTER] to accept the selection.

Pressing [ESC] cancels the operation at any time and closes the window. To make searching easier, the file list may be sorted according to different criteria.

How to search an element from the list

An element (folder or file) may be selected from the list by moving the cursor to the desired element or using an alphanumeric keyboard. Pressing a key will select the first element from the list starting with that letter or number. Pressing it again will select the second one and so on.

The files can also be selected using the "Find file" softkey.

Sorting the list of files



The file list may be ordered alphabetically, by size or by date.

- When using a mouse, select the column header with the pointer. Every time the same header is selected, it toggles the sorting criteria from ascending to descending and vice versa.
- From the softkey menu. Every time the same softkey is selected, the CNC toggles the sorting criteria from ascending to descending and vice versa.

Search a file

The option "file search" of the softkey menu may be used to look, in the selected folder, for all the files whose name contain the indicated text. When selecting this option, the CNC shows a dialog box requesting the text to be found. The programs are searched one by one.

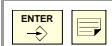
It may be searched using either the softkey menu or the following keys. Depending on how the search is carried out, the focus goes to the last file found, whose name also appears at the top of the window. To end the search, press [ESC].

Key.	Meaning.
	Search for the next program (in descending order).
	Search for the previous program (in ascending order).
	End the search and close the dialog box.

When defining a search, the softkey menu shows the "Next" (up) and "Previous" (down) options.

3.

HOW TO OPERATE THE CNC
File selection window

3.8 Calculator

The calculator may be accessed from any task window or directly using the key combination [CTRL]+[K]. Press [ESC] to close the calculator.

The calculator may be accessed from any operating mode. When accessing from an editable element, the result displayed by the calculator may be inserted. An editable element is any element that may have a focus or cursor, such as the program editor, tables, editable data, etc.

To insert the result, press the [INS] key. It closes the calculator and inserts the result in the position that the cursor had when accessing the calculator.

The calculator looks like this

The calculator looks like this.

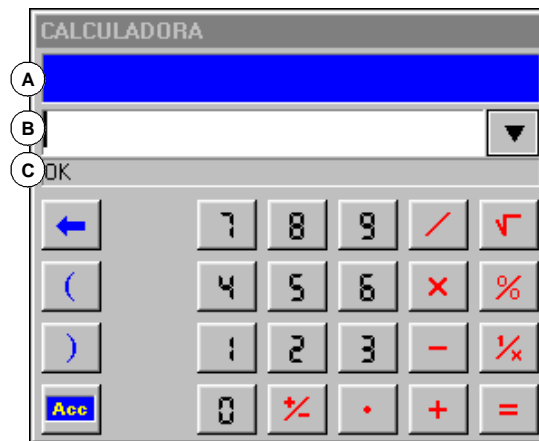

- A** Results window. It shows the result of the expression after accepting it with the [ENTER] key. This value may be recovered with the "Acc" button so it can be used in later calculations.
- B** Editing window. It shows the expression being defined. The expression may consist of one or several operations that may be defined directly from the keyboard or with the softkey menu options. The editing window saves the list of the last operations.
- C** Explorer window. It shows, at all times, the result from evaluating the expression being defined. When selecting a portion of the expression at the edit window, it will show the result from evaluating that portion.

The result from evaluating the expression may be:

OK: #####	Numeric.
OK: 1.#INF	Infinite.
Error: <>	Syntax error.
Wrong expression	Wrong expression.

Operations history

The expressions already accepted become part of the history and may be displayed using the relevant keys [↑][↓]. After selecting an expression from the window, press the [ENTER] key to recover it. The [ESC] key closes the history window.

3.

HOW TO OPERATE THE CNC
Calculator



CNC 8060
CNC 8065

(REF: 1402)

Softkey menu

The softkey menu shows all the available operations. The expressions may be edited using either the softkey menu or the mouse with the calculator keys.

Work units

The result of the operations may be given in various units. Use the following icons to change the units. It highlights the units currently selected.



Hexadecimal (\$), decimal (D) or binary (B) units.



Units in degrees or radians.

3.

HOW TO OPERATE THE CNC
Calculator



CNC 8060
CNC 8065

(REF: 1402)

3.8.1 Defining expressions

An expression may consist of one or more operations. Each one of them may be defined by any valid combination of variables, constants, functions and operations. Press [ENTER] To accept the expression entered and calculate the value.

Quick parenthesis insertion

To place a portion of an expression between parenthesis, select the portion and press one of the parenthesis keys "(" or ")". If while a portion of the expression is selected, an operation key is pressed, the selection will appear between parenthesis and it will be preceded by the operation just defined.

Example: Having the expression "1+1/X+1/(X+1)+1". When selecting the "1/(X+1)+1" portion and pressing the "SIN" option, the expression will become "1+1/X+Sin(1/(X+1)+1)".

Variables for the calculator

The calculator offers up to 26 variables (from "A" to "Z", except "Ñ",) may be used to store numeric values and use them later.

Assigning a value to a variable: A = 34.234

Reference to a variable: Sin(A/2)

A single expression may contain both assignment and reference operations. Use the ":" character as separator.

A=34.234:Sin(A/2) is the same as Sin((A=34.234)/2)



The values of the calculator variables "A" - "Z" are independent from the values of local parameters "A" - "Z" (also called P0 through P25).

Constants

The following constants are available and they may be accessed from the softkey menu.

PI	Value of pi (3.14159...)
MM -> INCHES	mm/inch conversion factor.
INCHES ->MM	inch/mm conversion factor.

Various operations

In the following examples, the "x" and "y" values indicate any valid combination of constants, variables or expressions.

Arithmetic operations.

$x + y$	Add	
$x - y$	Subtract	
$x * y$	Multiply	
x / y	Divide	
$x \% y$	Percentage	10%50 = 5
$x ^ y$	Power	$2^3 = 2 * 2 * 2 = 8$
$x!$	Factor	$3! = 3 * 2 * 1 = 6$



CNC 8060
CNC 8065

(REF: 1402)

Trigonometric operations.

SIN(x)	Sine	SIN 30 = 0.5
COS(x)	Cosine	COS 60 = 0.5
TAN(x)	Tangent	TAN 45 = 1
INV SIN(x)	Arc-sine	InvSin 0.5 = 30
INV COS(x)	Arc-cosine	InvCos 0.5 = 60
INV TAN(x)	Arc-tangent	InvTan 1 = 45

Conversion functions.

MM -> INCHES	It converts from millimeters to inches.	
INCHES ->MM	It converts from inches to millimeters.	
ABS(x)	Absolute value.	
INT(x)	Integer.	

Binary operations.

AND	Binary AND	1001 AND 1010 = 1000
OR	Binary OR	1001 OR 1010 = 1011
XOR	Exclusive OR	1001 XOR 1010 = 0011
NOT	Inverse	NOT 101 = 1...1010

Extended functions

SQRT x	Square root	SQRT 16
LN x	Neperian log	LN 100
LOG x	Decimal log.	LOG 100
e ^ x	"e" function	InvLn 3
10 ^ x	Decimal exponent	InvLog 50
INTEGRAL x	It calculates the integral	N=100:A=1:B=5:Integral(x+2)
ZERO x	Function zero	N=100:E=1e-10:A=5:Zero(x^2)

INTEGRAL function

It returns as result, the integral defined by the function between the limits defined by the "A" and "B" variables.

The precision of the result depends on the "N" variable, that indicates the number of intervals used to divide the function in order to calculate the integral. If "N" is less than or equal to zero, it will be ignored and the number of intervals will be 100. If "N" is greater than 500000, the intervals will be 500000.

ZERO function

It returns as result, the value that makes the function to be zero. Since there may be several values satisfying this condition, the result will depend on the initial value of the exploration defined with the "A" variable.

The precision of the result depends on the "N" variable that indicates the number of iterations of the resolution algorithm. If "N" is less than or equal to zero, it will be ignored and the number of iterations will be 100. If "N" is greater than 500000, the intervals will be 500000.

The "E" variable defines the error allowed so the result of the function with the calculated value is smaller than "E". This variable is useful when not knowing what value to assign to "N". In that case, it is recommended to assign to "N" a very large value and to "E" the error allowed.

3.

3.9 Dialog boxes

The dialog boxes consist of the following elements. All the actions may be carried out with the mouse or via keyboard.

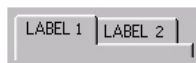

- Selection panels.
It selects among the different option groups within the same dialog box.



- Drop list.
It selects an option from a list. Clicking on the right icon, the list expands.



- Selection box.
It activates an option.

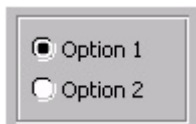

- Option selection.
It selects an option from a group. Selecting one cancels the previous one.



- Color pallet.
Select a color.

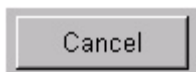

- Selection buttons.
They access a group of options or close the dialog box.
After making the changes, the dialog boxes are closed using one of the buttons that let you accept or reject the changes made.

Using the keyboard

The data of the dialog boxes are defined via keyboard as follows.

- Using the [CTRL]+[TAB] combination, it is possible to select different panels of the dialog box.
- The [TAB] key moves the cursor through the elements of the box.
- The [SPACE] key activates the selection boxes, selects an options and selects a color from the color pallet.
- The [ENTER] key presses the button that is selected.
- The [ESC] key closes the dialog box without accepting the changes.
- On the drop lists, the desired option may be selected using the keys on the keyboard.
- The arrow keys [←][→][↑][↓] move the cursor over the color pallet and over the options of a list.

3.

3.

HOW TO OPERATE THE CNC

Dialog boxes



CNC 8060
CNC 8065

(REF: 1402)

AUTOMATIC MODE

4

4.1 Interface description.

The automatic mode may consists in one or more pages (screens) of data or graphics.

- The data screens may show information related to execution, axis position, "M" and "G" function history, active tool and tool offset, spindle speed and axis feedrate. When this screens shows a window with the program selected for execution, it will be possible to select the execution starting and ending conditions as well as to recover the program history up to a particular block.
- The graphic screen shows a graphic representation of the program during execution. It also allows taking measurements on the graphics.

Description of a typical data screen.

A typical data screen of the automatic mode can show the following information:

- A** Program window. It shows data on the program selected for execution and lets selecting the initial and final execution blocks.

When accessing the automatic mode and after finishing the execution of the program, it shows the portion of the main program even if there are local subroutines defined in the program. It shows the following data.

- Blocks of the program or subroutine being executed.
- Line of the program where the cursor is.

During execution, the window shows the following information.

- The cursor shows the block being executed.
- The bottom shows the line number being executed (Line) and, if necessary, the line number where the execution was canceled (INT).
- If the program has been executed before, the bottom shows the percentage of the program that has been executed already (Time). Once a program has been executed, the CNC knows how long it took and in later executions it shows the percentage of the program executed so far. This percentage will be reliable as long as the



CNC 8060
CNC 8065

(REF: 1402)

percentage of feedrate is not changed with respect to when it was executed for the first time.

B Information related to the position of the axes. In the screen configuration supplied by Fagor, the data displayed will be different on each screen. Displaying the following information is the most typical.

- The programmed coordinate, in other words, the target position.
- The current position of the axes referred to part zero or machine reference zero (home) being this position referred to the tip of the tool or to its base.
- The following error (axis lag).

If the name of the axis appears in red, it means that the PLC is inhibiting the movement of the axes (INHIBIT mark active).

C Active "M" functions.

D Active "G" functions and high-level commands.

E Tool related information. The information the CNC shows in this area depends on the model, lathe or mill.

At a mill model, the screen shows the number of the active tool "T", the active tool offset "D" for that tool and the number of the next tool "Nx Tool" and an icon representing the type of tool. The CNC also shows the radius and length of the active tool.

At a lathe model, the screen shows the number of the active tool "T", the active tool offset "D" for that tool and an icon representing the type of tool. The screen also shows the tool offsets on each axis.

F Information related to the feedrate "F" of the axes:

"F real" Actual feedrate of the axes.

"F prog" Programmed feedrate. When setting a new feedrate in the MDI/MDA mode, it will become the new feedrate for the automatic mode.

"F%" Percentage of feedrate override being applied on to the programmed value.

If the text "F real" appears in red, it means that the PLC is inhibiting the movement of the axes (`_FEEDHOL` mark active). The status of the mark is not displayed if the screen does not show this text.

G Information related to the spindle speed "S".

"S real" Actual spindle speed.

"S prog" Programmed speed.

"S%" Percentage of speed override being applied on to the programmed value.

Depending on the active screen, it will also show the spindle position "S pos" and its following error "S fwe".

The screen only shows the data on one spindle. If there are several spindles in the channel, the data on the next spindle may be displayed by pressing the "S" key.

If the text "S real" appears in red, it means that the PLC is inhibiting the movement of the spindle (INHIBIT mark active). The status of the mark is not displayed if the screen does not show this text.

H Execution (cycle) time "Cy Time" of the program and number of parts made "Part Ct".

I CNC messages.

4.

AUTOMATIC MODE Interface description.



CNC 8060
CNC 8065

(REF: 1402)

4.1.1 Softkey menus.





Horizontal softkey menu.

When selecting the program screen, the horizontal softkey menu shows the following options.

Softkey.	Description.
Block selection.	Select the first and last block of the execution either manually or through a block search.
Simulated execution.	Show the available simulated execution modes.
Display.	Toggle between the various screens of the automatic mode and display information related to the status of the subroutines, canned cycles, repetition blocks and loops.
MDI.	Access the MDI/MDA mode.
Exblk.	Execute only the block selected with the cursor.
Graphics.	Show the graphics screen.
Single block.	Activate the single block execution mode.

Vertical softkey menu.

The vertical softkey menu always shows all the options associated with this operating mode regardless of the active screen.

Softkey.	Description.
	Select a program for execution.
	Begin tool inspection. Tool inspection is only available when program execution is interrupted.
	End simulated execution and start executing the program
	Select the program that is being edited.

4.

AUTOMATIC MODE
Interface description.

4.2 Display the status of the program or of the active subroutines.

From the horizontal softkey menu, it is possible to toggle between the display of program blocks and the display of information related to the status of the subroutines, canned cycles, repetition blocks and loops.

Having this option active and the program execution interrupted, the user can use the cursor to select an information line and press [ENTER] to skip to the corresponding program block.

4.

AUTOMATIC MODE
Display the status of the program or of the active subroutines.

Description of the information displayed.

The information is laid out in a table with four columns and having the following meaning.

Column.	Meaning.
S	Nesting level of the subroutine.
P	Nesting level of the local parameters used in the subroutine.
Sub	Name of the program, subroutine or canned cycle.
Op	Type of block being simulated. The loops are shown with a progress bar and a text indicating the loop it is in.

The window shows the following information.

Type of block.	Information displayed.
L	Name of the subroutine
LL	Name of the subroutine
#CALL	Name of the subroutine
#PCALL	Name of the subroutine
#MCALL	Name of the subroutine
G180 through G189	Name of subroutine associated with the G function.
M function.	Name of the subroutine associated with the M function.
T function.	Name of the subroutine associated with the T function.
Canned cycle.	G function associated with the canned cycle.
#EXEC	Name of the subroutine
\$RPT	Number of current loop and total number of loops.
\$FOR	Number of current loop and total number of loops.
\$WHILE	Number of current loop.
\$DO	Number of current loop.
\$IF	Text "IF".
\$SWITCH	Text "SWITCH".





CNC 8060
CNC 8065

(REF: 1402)

4.3 Program simulation and execution.

4.3.1 Select program.

The CNC allows selecting and executing a different program in each channel. Each channel executes the program selected in it. To select a program, press one of the following softkeys of the vertical menu.

Softkey.	Meaning.
	This softkey shows the list of available programs. See " 3.7 File selection window " on page 63.
	This softkey selects directly the program being edited in the same channel.

Once a program has been selected, its name appears on the general status bar. For each channel, it shows the name of the program selected in that channel.

4.

AUTOMATIC MODE
Program simulation and execution.

FAGOR 

CNC 8060
CNC 8065

(REF: 1402)

4.3.2 Select the first and last blocks of the execution.

After selecting the "block selection" softkey, the horizontal softkey menu shows the following options.

Softkey.	Description.
Set beginning	First block for execution or for manual block search.
Stop condition.	Set the condition to end the execution or the manual block search.
Automatic block search.	Do an automatic block search.
Manual block search.	Do a manual block search.
Find text.	Find text

Set beginning.

This option sets as starting block for execution the block selected with the cursor. When not setting the starting block, the program will begin executing from the first block.

The first block may be selected using the cursor or the "Find text" option of the softkey menu. The selected block stays active until canceled (selecting another block or selecting the same one again) or executing the program.

Stop condition.

This option sets the block where the execution of the program or subroutine will be interrupted. After executing that block, the execution may be resumed with the [START] key or canceled with the [RESET] key. If the last block is not set, the program execution will end executing one of the end-of-program functions "M02" or "M30".

Select subroutine.

This option selects the stop condition in a global subroutine which has been called upon from the program. When selecting this option, the CNC shows a list of the available subroutines. After selecting the desired subroutine, it will appear in the program window.

Set stop block.

This option sets as execution interruption block the block selected with the cursor. If the last block is not set, the program execution will end executing one of the end-of-program functions "M02" or "M30".

The last block may be selected using the cursor or the "Find text" option of the softkey menu. The selected block stays active until canceled (selecting another block or selecting the same one again) or executing the program.

Number of times.

This option sets as stop condition, that the block selected as the last block has been executed a specific number of times.

When selecting this option, the CNC requests the number of times that the block must be executed before ending the execution of the program. After entering the number of times, press [ENTER] to validate the value or [ESC] to cancel it.

4.

AUTOMATIC MODE

Program simulation and execution.



CNC 8060
CNC 8065

(REF: 1402)

Automatic block search.

This option recovers the program history up to the block where the previous execution was canceled. The CNC remembers the block where interruption was canceled, thus not being necessary to set the stop block. If after the block search, the execution is resumed from that point, it will do it in the same conditions as if it were executed from the beginning. See "4.6 Block search." on page 94.

When this option is active, the softkeys that define the execution conditions are applied to the block search.

Set beginning.

This option sets as starting block for block search the block selected with the cursor. If the first block is not defined, the block search starts at the first block of the program.

Manual block search.

This option recovers the program history up to a particular block of the program or of the subroutine, set by the operator. If after the block search, the execution is resumed from that point, it will do it in the same conditions as if it were executed from the beginning. See "4.6 Block search." on page 94.

When this option is active, the softkeys that define the execution conditions are applied to the block search.

Set beginning.

This option sets as starting block for block search the block selected with the cursor. If the first block is not defined, the block search starts at the first block of the program.

Stop condition.

This option sets the block of the program or of a subroutine where the block search will be interrupted.

- Select subroutine. This option selects the stop condition in a global subroutine which has been called upon from the program.
- Set stop block. This option sets as block search interruption block the block selected with the cursor.
- Number of times. This option sets as stop condition, that the block selected as the last block has been executed a specific number of times.

If a block containing a multiple machining cycle (-M- model) has been selected as a stop block, the block search will end just before the beginning of the nth modal cycle repeated in the multiple machining.

Find text.

This option shows a dialog box for placing the cursor on a particular line of the program or search for text or a character string in the program.

Go to line.

In this area of the dialog box, the CNC requests the line number to go to. Key in the desired number and press [ENTER], the cursor will then go to that line.

Find text

In this area of the dialog box, the CNC requests the text to look for. It is also possible to select whether the search must start at the beginning of the program or at cursor position.

To start the search, press [ENTER] and the cursor will position on the text found. Pressing [ENTER] again, the CNC will look for the next match and so on. To end the search, press [ESC]. The cursor will position on the block containing the text searched.

4.

AUTOMATIC MODE

Program simulation and execution.

FAGOR
CNC 8060
CNC 8065

(REF: 1402)

4.3.3 Execute a program.

The name of the program selected in the channel for execution appears on the general status bar. If not indicated otherwise, the program execution will begin from the first block of the program to the execution of one of the end-of-program functions "M02" or "M30". As an option, it is possible to define the first and last blocks of the execution. See ["4.3.2 Select the first and last blocks of the execution."](#) on page 76.

Start executing

To start the execution of the program, press [START] on the Operator Panel.



When pressing [START], the CNC saves the program being edited, even if the programs being edited and executed are different.



Every time [START] is pressed, the CNC checks that the room temperature does not exceed 65 °C (149 °F) and, if it does, the CNC does not let run the program and issues the corresponding error message.

The program may be executed in –single block– or –automatic– mode; the mode may be selected even while executing the program. When –single block– is active, the screen will display the relevant symbol on the general status bar.

If the –single block– mode is active, program execution will be interrupted at the end of each block; the [START] key must be pressed again to execute the next block. If the –automatic– mode is active, the program will be executed all the way to the end or up to the block selected as end of execution.

Interrupting the execution

The [STOP] key interrupts the execution of the program. Press [START] again to resume execution from where it was interrupted.

The execution may be interrupted at any time, except when threading. In that case, it will be interrupted at the end of the threading operation.

Stop the execution

The [RESET] key cancels the execution of the program and resets the CNC to its initial conditions.



The program selected for execution may be executed in any operating mode by pressing [START] on the Operator Panel. The CNC will request confirmation before starting to execute the program.

Activate rapid traverse while executing a program.

If the OEM has set it this way (parameter RAPIDEN), while executing the program it will be possible to apply rapid traverse to programmed movements (except to G00 movements and to threading operations). Depending on how this option has been configured, rapid traverse may be applied from the PLC (for example using user keys) or with the "rapid" key of the jog panel or, on the other hand, it may be necessary to use both.



When only one of the two options is necessary to activate rapid traverse and the CNC has several channels, activating rapid traverse from the PLC only affects the corresponding channel. The rapid key, on the other hand, affects simultaneously all the channels that may be affected at the time. If the active channel is in jog mode and another channel is executing a program, when pressing the rapid key in the active channel (jog mode), the rapid traverse will also be applied in the channel that is executing the program.

The feedrate for these movements is set by the FRAPIDEN parameters of the axes and of the channel. If these parameters are set to zero, the CNC does not limit the feedrate and assumes the one set for G00. The feedrate cannot exceed the maximum feedrate set by PLC (variable (V.)PLC.G00FEED), but it can exceed the maximum machining feedrate (parameter MAXFEED of the axes and of the channel) and the active feedrate set by PLC (variable (V.)PLC.F).

4.

AUTOMATIC MODE
Program simulation and execution.



CNC 8060
CNC 8065

(REF: 1402)

4.3.4 Resume the execution of a program from the block where it was canceled.

After cancelling the execution of a program (error, reset, etc.) we usually want to resume the execution from a particular block, usually a few blocks ahead the interruption block. To do that, when cancelling the execution, the CNC saves and shows on the screen the block number where the execution was cancelled (INT=####).

The way to proceed, once the execution is cancelled, is as follows.

- 1 In automatic mode, using the "EXBLK" softkey, execute the header blocks of the program that set the machining conditions. See "[4.4 Executing program blocks separately.](#)" on page 88. The MDI/MDA mode allows changing the machining conditions at any time.
- 2 Once the machining conditions have been set, cancel the independent execution of blocks ("EXBLK" softkey) and press the block selecting softkey to find and set the starting block.
- 3 Select the text or line searching option. When the execution has been cancelled with reset or some error, the "Line" section of this window shows the line number where the interruption took place. Press OK to place the cursor on that program line.
- 4 If necessary, move the cursor to select another line. The "Set beginning" option sets as starting block for execution the block selected with the cursor.
- 5 Press [START] to begin executing from the selected block maintaining the history active at the time.



Through block search, the CNC offers, , the most complete way to resume program execution after interrupting (cancelling) the execution. Block search may be used to restore the program history up to a particular block, reposition axes, go into tool inspection, etc. See "[4.6 Block search.](#)" on page 94.

4.

AUTOMATIC MODE

Program simulation and execution.

FAGOR 

CNC 8060
CNC 8065

(REF: 1402)

4.3.5 Cancel the execution and resume from another block while keeping the history.

The CNC allows canceling the execution of an interrupted program ([STOP] key) keeping the program history (machining conditions) and resume execution at another previous or later block of the same program. Before resuming execution, it is possible to access the MDI/MDA mode and execute blocks. The CNC resumes the program at the selected block with the history active up to the interrupted block plus the changes executed via MDI/MDA.

This option to cancel and resume may be useful when combined with tool inspection, after canceling or finishing the repositioning of the axes. At that moment, it will be possible to select a program block, previous or after the interruption block, and resume program execution from that point on. When linking this option with the end of tool inspection, the repositioning of the axes always corresponds to the starting point of tool inspection and this repositioning is done before selecting the block to resume.

It acts as follows:



- 1 After interrupting the execution ([STOP] key), the vertical softkey menu of the automatic mode will show the following softkey. Pressing this softkey, the CNC interrupts the execution of the program keeping the history (machining conditions) active at the interruption point. The message bar indicates that a program block may be selected to resume execution.
- 2 If necessary, access the MDI/MDA mode to execute the necessary blocks to adapt to the new starting point (position the axes, change the machining conditions, etc.).
- 3 Select the new starting block to resume execution, it may be a block before or after the interruption block. The block is selected by moving the cursor throughout the program or through the search options for text or program line.
- 4 Once the starting block has been selected, press the [START] key to resume execution at that block. Resuming the program does not initialize or change the program history, nor does it take into consideration the possible changes programmed in the blocks that are not executed between the interruption block and the resuming block of the program. The CNC resumes execution with the history active up to the interrupted block plus the changes executed via MDI/MDA.

The CNC offers no automatic repositioning of axes. For positioning for example, at the starting point of the block where the execution is to be resumed, it must be done via MDI/MDA (if the exact point is known) or select as starting point the motion block right before the desired one.

Considerations before resuming the execution of the program.

It is up to the user to use this feature properly and in the right context, using the MDI/MDA mode to adapt the new starting point to the conditions of the interruption point if necessary. For example:

- When selecting an arc as the starting point, use the MDI/MDA mode to place the axes in their starting point; otherwise the CC will issue programming error messages or it will execute arcs different from the original one. This situation may also be solved by selecting as starting point a previous linear block that positions the axes in the starting point of the right arc.
- If G91 is active in the history of the program, position at the starting point of the original block; otherwise, the resulting path will be different because it will always be incremental with respect to the starting point.
- The execution cannot be canceled inside a canned cycle, both ISO and that of the cycle editor.
- Inside a loop (\$IF, \$GOTO, etc), the execution can only be resumed if the resuming block is at the same level as the block where it was canceled.

Modify the interrupted program.

If the interrupted program has a ".mod" extension, it may be modified from the editor while it is interrupted. It is up to the user to check that the changes he makes are coherent.

For the CNC to assume the changes, the modified block must be after the block where it resumes execution.

4.

AUTOMATIC MODE

Program simulation and execution.



CNC 8060
CNC 8065

(REF: 1402)

4.3.6 Simulated execution of a program.

With simulated execution, it is possible to simulate a program, interrupt it at a point and start execution from that point on. Depending on the type of simulation selected, it can involve movement of axes, spindle, etc. After interrupting the simulation and before starting the execution, the CNC allows changing the conditions of the program via MDI/MDA, moving the axes and acting upon the spindle from the jog keyboard and it also offers the possibility to reposition the axes and the spindles.

General operation.

Start the simulation of the program



- 1 On the horizontal softkey menu, select the desired type of simulation.
 - Theoretical travel.
 - G M S T functions.
 - Rapid.
 - G functions.
 - Main plane.
 - Rapid [S=0].
- 2 If necessary, set the desired simulation conditions (first and last block) See ["4.3.2 Select the first and last blocks of the execution."](#) on page 76.
- 3 Press the [START] key to start the simulation. The program may be simulated in "single block" or "continuous" mode; the mode may be selected even while simulating the program.

End simulation and start executing the program.

- 1 Press the [STOP] of the operator panel to interrupt the simulation. Once the program is interrupted, simulation may be resumed with the [START] key or switch to execution mode from the vertical softkey menu.

Softkey.	Description.
	End simulated execution and start executing the program

- 2 When switching to execution mode (after pressing the softkey), the CNC goes into tool inspection mode. In this mode, it is possible to reposition the axes, access the MDI/MDA mode to change the conditions of the program, etc. See ["4.5 Tool inspection."](#) on page 89.
- 3 To complete the tool inspection and before starting the execution of the program, the spindle turning direction must be restored and the axes repositioned. The vertical softkey menu offers two options.

Softkey.	Reposition point.
	Repositioning the axes at the interruption point.
	Repositioning the axes at the starting point of the interrupted block.

- 4 Press the [START] key to start the execution.

4.

AUTOMATIC MODE
Program simulation and execution.



CNC 8060
CNC 8065

(REF: 1402)

Types of simulation.

The simulation options are available on the horizontal softkey menu. By default, the menu only offers two of the options. To enable all the options, it is necessary to expand the softkey and access the configurator (last softkey).

	Graphic representation	Movement of the axes	Spindle control	Sends M-H-S-T to the PLC
Theoretical travel.	Programmed	No	No	No
G functions.	Tool center	No	No	No
G M S T functions.	Tool center	No	No	Yes
Main plane.	Tool center	Yes	Yes	No
Rapid.	Tool center	Yes	Yes	Yes
Rapid [S=0].	Tool center	Yes	No	Yes

Theoretical travel.

- The simulation ignores tool radius compensation (functions G41 and G42), hence drawing the programmed tool path.
- The simulation does not send M H S T functions to the PLC.
- The simulation does not move the axes of the machine nor starts the spindle.
- The simulation takes into account the dwells programmed with G4.
- The simulation takes into account the program stops programmed with M00 and M01.

G functions.

- The simulation ignores tool radius compensation (functions G41 and G42), hence drawing the tool center path.
- The simulation does not send M H S T functions to the PLC.
- The simulation does not move the axes of the machine nor starts the spindle.
- The simulation takes into account the dwells programmed with G4.
- The simulation takes into account the program stops programmed with M00 and M01.

G M S T functions.

- The simulation ignores tool radius compensation (functions G41 and G42), hence drawing the tool center path.
- The simulation sends M H S T functions to the PLC.
- The simulation does not move the axes of the machine nor starts the spindle.
- The simulation takes into account the dwells programmed with G4.
- The simulation takes into account the program stops programmed with M00 and M01.

Main plane.

- The simulation ignores tool radius compensation (functions G41 and G42), hence drawing the tool center path.
- The simulation does not send M H S T functions to the PLC.
- The simulation only executes the movement of the axes that make up the main plane. The axes move at the maximum feedrate allowed regardless of the programmed "F" value. It is possible to change that feedrate with the feedrate override switch.
- The simulation starts the spindle if it has been programmed.
- The simulation ignores the dwells programmed with G4.
- The simulation takes into account the program stops programmed with M00 and M01.

Rapid.

- The simulation ignores tool radius compensation (functions G41 and G42), hence drawing the tool center path.
- The simulation sends M H S T functions to the PLC.
- The simulation moves the axes of the machine. The axes move at the maximum feedrate allowed regardless of the programmed "F" value. It is possible to change that feedrate with the feedrate override switch.

4.

AUTOMATIC MODE
Program simulation and execution.



CNC 8060
CNC 8065

(REF: 1402)

- The simulation starts the spindle if it has been programmed.
- The simulation ignores the dwells programmed with G4.
- The simulation takes into account the program stops programmed with M00 and M01.

Rapid [S=0].

- The simulation ignores tool radius compensation (functions G41 and G42), hence drawing the tool center path.
- The simulation sends M H S T functions to the PLC.
- The simulation moves the axes of the machine. The axes move at the maximum feedrate allowed regardless of the programmed "F" value. It is possible to change that feedrate with the feedrate override switch.
- The simulation does not start the spindle, except when the spindle works in closed loop M19.
- The simulation ignores the dwells programmed with G4.
- The simulation takes into account the program stops programmed with M00 and M01.

4.

AUTOMATIC MODE
Program simulation and execution.



CNC 8060
CNC 8065

(REF: 1402)

4.3.7 Execute a program (retrace).

The retrace function stops the execution of the program and starts executing backwards the path traveled so far at the current block plus the last n blocks executed. The number of blocks to retrace has been preset by the OEM; a typical value being 75 blocks.

When the retrace function is canceled, the CNC resumes the normal execution of the program. During the retrace function, the program history is not updated; the CNC maintains the history of the point where the retrace function was activated.

4.

AUTOMATIC MODE

Program simulation and execution.

Turn the retrace function on.

This feature is handled by the PLC. Usually, this feature is turned on and off using an external push button or key configured for that purpose.

The retrace function may be interrupted with the [STOP] key. Pressing [START] while the retrace function is interrupted resumes the execution in retrace mode. The retrace function can also be executed block by block (single block mode). The single block mode may be activated at any time, even when the retrace function is active.

The retrace function may be activated during an interpolation, in the middle of a block and also at the end of the block, whether the execution was interrupted by M0 or by the single block mode.

The retrace function cannot be activated while executing G33, G63, G100 or G04 type blocks. The CNC first finishes the execution of these blocks and then activates the execution in retrace mode. In the case of G33, G63 and G100, the retrace function is canceled; with function G04, the execution in retrace mode continues.

When is the retrace function canceled.

The CNC channel cancels the retrace function in the following cases.

- The user cancels the retrace function.
Since this feature is handled from the PLC, the user may cancel it from the operator panel if the manufacturer has put a button or key for that.
- The CNC channel has executed all the blocks stored for the retrace function.
- The CNC channel has reached the beginning of the program.
- The CNC channel has reached a block that cannot be executed with the retrace function.

The retrace function is also canceled after a reset or an M30.

Resume the execution after the retrace function has been canceled.

How does the CNC resume the execution, once the retrace function has ended, depends on the setting of the PLC. If once the retrace function has ended, the CNC does not restore the normal execution of the program, it will show a warning indicating that the retrace function must be deactivated (e.g. from the outside operator panel if the manufacturer has provided a button or key to that effect). The same occurs when trying to execute a new program after executing the retrace function.

Influence of certain functions while executing in retrace mode.

Machining conditions.

Being retrace active, the movements are carried out backwards keeping the feedrate and the spindle used to execute them originally.

Activating, canceling and changing Constant Surface Speed (G96 G97) cancel the retrace function. However, if constant surface speed is on, it respects the change of spindle speed depending on the coordinate of the diameter axis.



CNC 8060
CNC 8065

(REF: 1402)

Tool and offset.

Blocks with T and D programming (next tool and offset) are ignored during the retrace function. Blocks with D programming (change of active tool offset) cancel the retrace function.

·M· functions.

The behavior of the retrace function when executing M functions depends on how the machine manufacturer has set it up. When the CNC finds an M function, it can either ignore it and keep executing blocks in retrace or cancel the "retrace" function. In any case, the following M functions behave as follows.

- Functions M00 and M01 are always executed; they are sent to the PLC and [CYCLE START] must be pressed to resume execution in retrace.
- Functions M03 and M04 are always ignored; the CNC does not start the spindle nor does it change its turning direction.
- While the spindle is running, function M05 cancels the "retrace" function; the CNC does not stop the spindle. If the spindle was stopped, this function is ignored.
- Functions M19, M41, M42, M43 y M44 cancel the retrace function.

Functions that cancel the retrace function.

Definition.	Functions and instructions.
Gear change.	M41 M42 M43 M44
Spindle orientation.	M19
Effective spindle stop. If the spindle was stopped, this function does not cancel the retrace function.	M5
Change of work plane.	G17 G18 G19 G20
Changing zero offset and fixture offsets, etc. Functions G53-G59, G159 only cancel the retrace function if they cancel an active zero offset.	G92 G158 G53-G59 G159
Probing.	G100 G101 G102 #SELECT PROBE.
Activate, cancel or modify constant surface speed.	G96 G97
"C" axis. The instruction #CAX OFF only cancels the retrace function if it cancels an active #CAX.	#CAX ON #CAS OFF #FACE ON #FACE OFF #CYL ON #CYL OFF
Tapping.	G33 G63.
Changes in feed-forward or in AC-forward.	G134 G135
Home search.	G74
Changing the parameter set.	G112
Changing the software limits.	G198 G199
Synchronizing.	#SYNC
High speed machining.	#HSC ON #HSC OFF
Incline axis. Freezing (suspending) an incline axis does not cancel the retrace function.	#ANGAX ON #ANGAX OFF
Slaving axes.	#LINK #UNLINK
Axis parking.	#PARK #UNPARK
Tangential control.	G45 G145 #TANGCTRL ON #TANGCTRL OFF #TANGCTRL SUSP #TANGCTRL RESUME
Axis swapping.	#SET AX #CALL AX #PUT AX #RENAME AX

4.

AUTOMATIC MODE
Program simulation and execution.



CNC 8060
CNC 8065

(REF: 1402)

4.

AUTOMATIC MODE

Program simulation and execution.

Definition.	Functions and instructions.
Changing tool length due to tool change.	#TOOL AX #TLC OFF
Programming in the machine coordinate system.	#MCS ON #MCS OFF
Coordinate transformation. Instructions #ACS DEF, #ACS ACT, #CS DEF and #CS ACT do not cancel the retrace function.	#ACS ON #ACS OFF #ACS NEW #CS ON #CS OFF #CS NEW #RTCP OFF
Kinematics change.	#KIN ID
Independent axis.	#MOVE #MOVE ABS #MOVE ADS #MOVE INF
Electronic cam.	#CAM ON #CAM OFF #FOLLOW ON #FOLLOW OFF



CNC 8060
CNC 8065

(REF: 1402)

4.3.8 Executing a program in 8055 MC/TC language.

A program edited in 8055 MC/TC language may be executed at the CNC in two ways.

- Keep the program extension (.pim or .pit) and enable at the editor the compatibility with 8055 programs. Before executing or simulation the program, the CNC translates (converts) it. The CNC always simulates and executes the converted program, which is also the one shown on the screen during the execution.
- Change the program extension (.pim or .pit) or disable at the editor the compatibility with 8055 programs. In either case, the CNC tries to execute the program as if it were in its own language. The CNC will interpret the programmed canned cycles (PCALL instructions), but it will issue an error message if there is any instruction in 8055 language.

The conversion of the part-program.

The CNC translates the program is only converted one; the first time it simulates the program or the first time that it selects the program in automatic mode. The CNC keeps both programs; the one written in 8055 format (the one edited) and its equivalent translated. If when selecting the program, a file with extension .pit or .pim is selected, the CNC opens the converted file and displays it on the screen. The converted (translated) program is saved in the following folder with the same name but with the extension m55 (milling program) or t55 (lathe program).

C:\Cnc8070\Users\Prg\PRG_8055_TO_8070

When modifying the program edited in the 8055 CNC language, the CNC converts it again. When modifying the converted program, the CNC does not update the one written in 8055 CNC language.

If any error occurs during execution, the CNC will display the block that caused it. The block will be in the language of the CNC, but it will be easily identified due to the translation format.

Considerations for program execution.

- The tool offsets programmed in 8055 language are always interpreted as D1 at the CNC.
- At the 8055 MC, 3D pockets are defined in several files (plane profile and depth profiles). Only import into the CNC the file generated by the cycle editor which already contains the geometry of all the profiles. The name of the file will be 995###.pim, where ### is the value of the CAJ.3D field on the editing page of the cycle.
- Some cycles of the 8055 TC are not available at the CNC, such as the Y-axis cycles (profiles, rectangular pockets, circular pockets and 2D pockets in the YZ and XY planes) and the rectangular, circular and 2D pockets in the ZC and XC planes. The CNC will also execute these cycles even if they are not available at the cycle editor.
- If the 8055 program contains work zones, when executing the original program (.pim or .pit) without translating, the CNC will issue an error message because they are missing at the CNC. When executing the translated program (.m55 or .t55), the CNC will ignore the work zones and will not issue any error message.
- To change a program in 8055 language by adding blocks in the CNC's own language, you need to change the extension of the file (.pim or .pit) to prevent the translator (converter) from issuing an error.
- The CNC accepts numerical block labels (N9999) in 8055 format, programmed in RPT and GOTO instructions, but it can only find them if there are in blocks after the calling instruction. If the block is in a previous line, it must have the format of the CNC label adding the ":" character.

4.

AUTOMATIC MODE

Program simulation and execution.

FAGOR 

**CNC 8060
CNC 8065**

(REF: 1402)

4.4 Executing program blocks separately.

From the automatic mode, it is possible to execute blocks of a program separately; i.e. it is possible to select a block of the program and execute only that block. Blocks executed like this change the history of the M and G functions.

Press the "EXBLK" softkey of the horizontal menu to enable this function. Being this option active, every time the [START] key is pressed, it only executes the block selected in the active program. Once that block is executed, another block may be executed by selecting it with the cursor and pressing [START] again and so on. The blocks may be selected with the [↑] [↓] keys.

4.**AUTOMATIC MODE**

Executing program blocks separately.



CNC 8060
CNC 8065

(REF: 1402)

4.5 Tool inspection.



There are some exceptions or particular cases where this tool inspection cannot be accessed. In these cases, the CNC enables a particular tool inspection as explained in the next section.

- The CNC is executing the program in retrace mode.
- The independent interpolator is involved in the movement of an axis (#MOVE, #FOLLOW, #CAM, etc).
- A rigid tapping is active (the rest of the threading do not admit any type of inspection.).

When the execution is interrupted, tool inspection allows jogging the axes, start and stop the spindle, execute blocks in MDI/MDA mode, etc. When tool inspection is done, it allows repositioning the axes to the interruption point or to the starting point of the interrupted block and resume program execution.

If an error occurs in tool inspection mode and it may be eliminated by pressing [ESC], it will not affect the inspection process. If eliminating the error requires a reset, the CNC will request confirmation because a reset cancels the inspection.

The way to operate in tool inspection may be summarized in the following steps.

- 1 Interrupt the execution of the program and start tool inspection.
- 2 Run the operations of tool inspection, such as jogging the axes, start and stop the spindle, execute blocks in MDI/MDA mode, etc.
- 3 Reposition the axes and restore the spindle turning direction.
- 4 Resume the execution of the program.

Begin tool inspection.



Tool inspection may be accessed from the vertical softkey menu only when the execution of the program has been interrupted ([STOP] key). Activating tool inspection makes the following operations possible:

- Jog the axes with the JOG keys.
- Act upon the master spindle of the channel from the operator panel.
- Execute blocks in MDI/MDA mode.

Once tool inspection is completed and before resuming the execution of the program, the spindle turning direction must be restored and the axes repositioned.

Execute blocks in MDI/MDA mode.

Any program block may be executed in MDI/MDA mode. The conditions when entering the MDI/MDA mode will be those of the interruption point; i.e. the CNC maintains the history of active G and M functions, feedrate, spindle speed, tool and other commands that were programmed. However, the CNC treats the following functions and commands in a special way.

- The CNC assumes function G1 when resuming execution after tool inspection, restores the function that was active at the interruption point.
- The CNC activates the suspended angular transformation (#ANGAX); it restores them when resuming execution after tool inspection.
- The CNC cancels tangential control (#TANGCTRL); it restores it when resuming execution after tool inspection.
- The CNC assumes function G40 when resuming execution after tool inspection, restores the function that was active at the interruption point. If either G40, G41 or G42 is programmed in MDI, the CNC stores it without making it effective; it applies it when resuming execution after tool inspection.
- If at the time of the interruption, there is a #TOOL ORI movement in execution or pending, it is not made effective in blocks programmed in MDI; the movement is executed when resuming execution after tool inspection.
- The CNC does not execute cycles or modal subroutines that are active in the interrupted program, nor calls to other subroutines.
- If the active mirror functions are changed in MDI mode, the changes will affect the following blocks edited in MDI; but not the movements in jog, or repositioning or the end

4.

AUTOMATIC MODE
Tool inspection.

FAGOR 

CNC 8060
CNC 8065

(REF: 1402)

point of the interrupted block. The interrupted program assumes the changes from the next block on.



- The CNC cancels functions G200 and G201 (manual intervention); it restores them when resuming execution after tool inspection.

In general, all the changes made in MDI/MDA mode are kept active when resuming the program after tool inspection except the following functions that are restored at the time of interruption.

- The CNC restores the type of interpolation G00, G01, G02, G03, G33 or G63 that was active at the time of the interruption.
- The CNC restores function G90 or G91 that was active at the time of the interruption.
- The CNC restores the status of function #MCS that was active at the time of the interruption.

Repositioning the axes and the spindle.

To complete the tool inspection and before resuming the execution of the program, the spindle turning direction must be restored and the axes repositioned. The vertical softkey menu offers two options.

Softkey.	Reposition point.
	Repositioning the axes at the interruption point.
	Repositioning the axes at the starting point of the interrupted block.

After selecting one of these two options, the vertical softkey menu shows a list of axes that are out of position. If the status of the master spindle has changed during the inspection, the softkeys will show the M3, M4, M5 or M19 function to restore.



If the execution is interrupted during a polynomial interpolation (#POLY), the axes must be repositioned to the beginning of the interrupted block in order to be able to redo the same path.

Repositioning the axes.

The CNC allows repositioning the axes either one by one or in groups. Use the vertical softkeys to select the axes to be repositioned and press [START]. The CNC will reposition the axes at the selected point (according to the softkey selected earlier) at the feedrate set by the machine manufacturer. Once one axis has reached its position, it will no longer be available.

The movement of the axes may be interrupted with the [STOP] key, after which it is possible to jog the axes using the jog keyboard. After interrupting a movement, it is necessary to select again the axes to be repositioned.

Repositioning the master spindle.

The spindle turning status may be restored either together with the repositioning of the axes or separately. The same vertical softkeys will show the M3, M4, M5 or M19 to be restored. If the spindle was interrupted in a positioning with M19, repositioning will complete that positioning. Once the spindle has recovered its status, it will no longer be available.

Canceling repositioning.

The CNC admits the possibility to end tool inspection before it is completed; i.e. without having repositioned all the axes. The vertical softkey menu, next to the list of axes, shows the following softkey to cancel repositioning.

Softkey.	Meaning.
	Canceling repositioning.

4.

AUTOMATIC MODE

Tool inspection.





CNC 8060
CNC 8065

(REF: 1402)

Manual tool calibration.

Tool inspection also allows accessing manual tool calibration. Once the tool has been calibrated, exit tool inspection, the CNC requests repositioning the axes before resuming program execution. The softkey to access tool calibration will be different depending on the software installed (lathe model or mill model). See "[6.1 Manual calibration. Calibration without a probe](#)" on page 115.

Softkey.	Type of calibration.
	Tool calibration in a mill model.
	Tool calibration in a lathe model.

Resuming the execution of the program.

Once all the axes are repositioned or after canceling repositioning, press [START] to resume program execution.

- If tool inspection has ended by repositioning all the axes, when pressing [START], the CNC completes the interrupted path and goes on with the rest of the program.
- If tool inspection has ended after canceling the repositioning of the axes, when pressing [START], the axes move from their current position to the end point of the interrupted path and then the CNC goes on with the rest of the program.

4.

AUTOMATIC MODE
Tool inspection.

FAGOR 

CNC 8060
CNC 8065

(REF: 1402)

4.5.1 Tool inspection (execution in retrace mode, independent interpolator or rigid tapping).

In the following cases, the CNC uses a particular case of tool inspection that also allows moving the axes, acting upon the spindle and changing the feedrate, spindle speed, executing M functions, etc. using the MHFS mode.

- The CNC is executing the program in retrace mode.
- The independent interpolator is involved in the movement of an axis (#MOVE, #FOLLOW, #CAM, etc).
- A rigid tapping is active (the rest of the threading do not admit any type of inspection.).

When in one of the previous cases, the execution is interrupted, this tool inspection allows the following operations:

- Jogging the axes using the JOG keys of the operator panel or handwheels.
- Stop and start the spindle using the keys on the operator panel.
- Access the CNC tables (tools, tool offsets, etc.) and modify their data.
- Changing the machining conditions executing any M, F, H, S function through the MHSF softkey.

Once tool inspection is completed and before resuming the execution of the program, the spindle must be started and the axes repositioned to the point where tool inspection began. Once the axes are repositioned, press [START] to resume program execution.

Rigid tapping and tool inspection mode

When interrupting the rigid tapping and accessing the tool inspection mode, it is possible to jog the axes (only in jog mode) that are involved in threading. When moving the axis, the interpolated spindle will also move; the spindle used to make the thread. If rigid tapping involves several axes, when moving one of them, all the other ones involved in the thread will also move.

This allows moving the axis into or out of the thread as often as desired until pressing the repositioning softkey. The axes move at the programmed F except when an axis or spindle exceeds its maximum feedrate allowed (parameter MAXMANFEED), in which case, the feedrate will be limited to that value.

The spindle jogging keys are disabled during tool inspection. It is only possible to get out of the thread by jogging one of the axes involved in rigid tapping. Functions M3, M4, M5 and M9 cannot be programmed at the spindle; they are ignored.

While repositioning, when selecting one of the axes of the thread on the softkey menu, it will move all the axes and spindle involved in the thread.

Repositioning the axes and the spindle.

To end tool inspection and reposition the spindle and the axes at the point where tool inspection began, press the relevant icon. The axes and the spindle may be repositioned simultaneously.

After pressing this icon, the CNC will show a list of the axes that are out of position. If the spindle was stopped during tool inspection, next to the list of axes, it will also show the status that the spindle had before the inspection.

Repositioning the axes.

The axes may be repositioned one by one or all at the same time. To reposition them, select the axes with the relevant softkey and press [START]. The axes reposition at the feedrate defined by the OEM.

The axes may be repositioned using the JOG keys or handwheels. On the other hand, repositioning may be interrupted (using the [STOP] key) to select other axes. Once one axis has reached its position, it will no longer be available.

4.

AUTOMATIC MODE
Tool inspection.



CNC 8060
CNC 8065

(REF: 1402)

Restoring the spindle turning direction.

The spindle turning direction may be restored together with the axes or separately. To do this, it shows, next to the axes to be repositioned, the previous status of the spindle (M3, M4 or M19). To restore the turning direction, select the softkey and press [START].

Changing the machining conditions.

When entering into tool inspection mode and also after repositioning the axes, it is possible to change the machining conditions using the "MHSF" softkey. Pressing this softkey allows editing the feedrate and speed values, as well as activating M and H functions. Press [START] to assume the new values. The CNC keeps the new values when resuming the execution.

Use the [TAB] key to move through the various data. Press [ESC] or the "MHSF" softkey to return to the standard screen of the automatic mode.

4.

AUTOMATIC MODE
Tool inspection.

FAGOR 

CNC 8060
CNC 8065

(REF: 1402)

4.6 Block search.

With block search, it is possible to recover the program history up to a particular block in such way that if program execution is resumed at that block, it will do so with the same conditions as if it were executed from the beginning.

When recovering the program history, the CNC reads it up to the indicated block activating the "G" functions it reads along the way. Likewise, it sets the feedrate and spindle speed conditions of the program and calculates the position where the axes should be. The M functions are sent depending on how the machine is configured; they may be sent while reading the program or at the end of the program.

Block search and canned cycles.

If a canned cycle is not selected as stop block, the block search only simulates the T, F, S changes and the movement to the last point. The surface milling, grooving and profile machining cycle, instead of simulating the movement to the last point, simulate a movement to the point defined by the safety Z and the reference corner or profile entry point.

If a block containing a multiple machining cycle has been defined as a stop block, it is possible to define the number of times that the machining operation is repeated. The block search will end just before the beginning of the n-th modal cycle repeated in the multiple machining operation.

Types of block search.

The CNC has two search modes, automatic and manual. See ["4.3.2 Select the first and last blocks of the execution."](#) on page 76.

Automatic block search.

The automatic block search may be used to recover the program history up to the block where the previous execution was canceled. The CNC remembers the block where interruption was canceled, thus not being necessary to set the stop block.

Manual block search.

The manual block search may be used to recover the program history up to a particular block of the program or of the subroutine, set by the operator. In this search, it is possible to set as an ending condition to repeat the stop block a particular number of times, for example multiple machining cycles, loops, etc.

Executing block search.

To recover the program history, proceed as follows:

- 1 Selecting the type of search: automatic or manual.
- 2 Selecting the stop block.

In the automatic block search, there is no need to select the stop block; by default, the CNC runs the search up to the block where the program was interrupted.

The manual block search requires defining the point where the search will end. The stop block may be in a subroutine. When selecting as stop block a block with repetition, multiple machining, etc. it is possible to define the number of times that this block must be repeated in order to end the search.

- 3 Selecting the starting block for the search. If the first block is not selected, the block search starts at the beginning of the program.
- 4 Press the [CYCLE START] key to start the block search.

The CNC reads the program up to the stop block, activates the "G" functions that it reads, sets the feedrate and spindle speed conditions and calculates the position where the axes should be. The M functions are sent depending on how the machine is configured; they may be sent while reading the program or at the end of the program.

- 5 Depending on how the treatment of functions M, H, F, S is configured, it may be necessary to decide which ones are sent out to the PLC.
- 6 Reposition the axes to the point to resume execution.
- 7 Tool inspection may be accessed to change the machining conditions.

4.

AUTOMATIC MODE
Block search.



CNC 8060
CNC 8065

(REF: 1402)

- 8 Press [START] to execute the program.

Repositioning the axes.

Once the block search is finished, the CNC will show the axes that are out of position. The axes may be repositioned individually or several at the same time in one of the following ways:

- Manually. Jog the axes with the handwheels or with the JOG keys. The movement is limited by the repositioning end point and the corresponding software limit.
- Automatically. Select the axes with the relevant softkey and press [START]. Repositioning may be interrupted (using the [STOP] key) to select other axes.

When an axis reaches the repositioning end point, it is no longer available; however, this axis may be moved with the handwheel or the JOG keys under the same conditions as before. Once all the axes have been repositioned, none of them may be moved.

Changing the machining conditions.

After positioning the axes and before resuming execution, tool inspection may be accessed to change the machining conditions. In tool inspection, it is possible to change the feedrate and the spindle speed, execute blocks in MDI/MDA mode as well as activate M and H functions.

4.

AUTOMATIC MODE
Block search.

FAGOR 

CNC 8060
CNC 8065

(REF: 1402)

4.6.1 Treatment of functions M, H, F, S.

Whether the functions M, H, F, S will be sent to the PLC or not during the block search depends on the setting of machine parameter FUNPLC. For the M function, it must also be borne in mind the how they have been set in the M function table.

The subroutine associated with the M functions is executed when the M is sent out to the PLC.

Machine parameters. M function table.

The M function table has an MPLC field to define whether the function is to be sent out to the PLC or not. All M functions set in the table will be sent out to the PLC or not depending on the setting of this field; the rest of M functions will be sent or not depending on the setting of machine parameter FUNPLC.

Machine parameter FUNPLC = Yes. The functions are sent out to the PLC.

In this case, the functions are sent out to the PLC during block search as they are being read. Once block search is finished and after positioning the axes, tool inspection may be accessed to change the machining conditions.

Machine parameter FUNPLC = No. The functions are not sent out to the PLC.

In this case, the functions are not sent out to the PLC during block search. After the search, the CNC screen shows the history of those functions so the user can enable them in the desired order.

- Mandatory "M" functions. List of M functions active up to the block reached and that must be executed in order to resume execution. These functions have a special meaning for the PLC.

This window will only show one of the functions are M03/M04/M05/M19 on one hand, M08/M09 on the other hand and M41/M42/M43/M44. The rest of the M functions such as M00, M01, M02, M6, M30 are not shown because they are not modal.

- Other M functions. List of "M" functions active up to the block reached. These functions do not have a special meaning for the PLC and need not be executed. These functions may be executed in any order, in groups or one by one, repeated, etc.
- H functions. List of "H" functions active up to the block reached. These functions may be executed in any order, in groups or one by one, repeated, etc.
- "F" and "S" functions. The programmed "F" and "S" values may be modified. The changes stay valid until they are modified by the program being executed.

Use the [TAB] key to move through the various windows. The [◀] [▶] keys may be used to move the cursor through the M and H functions of a window, the [ENTER] key selects them or deselects them and the [START] key executes them Press the "MHSF" softkey to return to the standard screen of the automatic mode.

The CNC shows the M and H functions sent out to the PLC in green and the ones selected to be sent to PLC in red.

4.

AUTOMATIC MODE
Block search.



CNC 8060
CNC 8065

(REF: 1402)

4.7 Show/hide the dynamic override of the HSC.

From the automatic mode, the user can change, during HSC machining, the dynamics set by program.

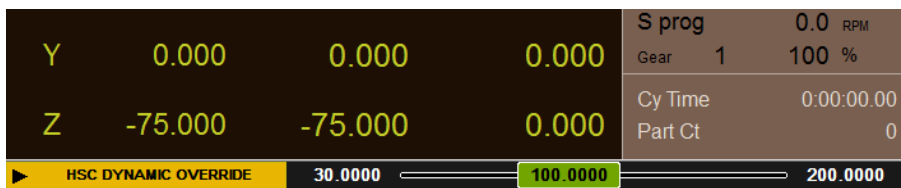

The [CTRL][H] hotkey shows/hides at the bottom of the screen, the dynamic override of the HSC. On this bar, a cursor may be used to change the percentage of the dynamics set by program. With the bar, it also shows the upper and lower limits (range) between which the value may be varied. Over the cursor, it shows the percentage being applied. The cursor may be moved with the mouse or with the moving arrows of the keyboard. The [ESC] key also hides the bar.

4.

AUTOMATIC MODE

Show/hide the dynamic override of the HSC.

FAGOR 

CNC 8060
CNC 8065

(REF: 1402)

4.

AUTOMATIC MODE

Show/hide the dynamic override of the HSC.



CNC 8060
CNC 8065

(REF: 1402)

MANUAL (JOG) MODE

5

When accessing the jog mode from the automatic mode, the CNC keeps the machining conditions selected in the last mode.

The channel does not allow accessing its manual mode if a program is being executed in the same channel or a block is being executed in MDI/MDA mode. If the execution of the program has been interrupted, the CNC will cancel the execution of the program and will go into jog mode. A program is interrupted when the [STOP] has been pressed or is waiting in single-block mode.

5.1 Interface description.

Description of a typical screen of this work mode.

A typical screen of the jog mode can show the following information:



A Information related to the position of the axes. In the screen configuration supplied by Fagor, the data displayed will be different on each screen.

The most common thing is to show the current position of the axes referred to part zero in large characters, and the amount of following error (axis lag) in small characters. Another more detailed option shows the coordinates of the tool tip and those of the tool base, being both referred to part zero and machine zero.



In handwheel mode, this symbol next to an axis indicates that the axis has an individual handwheel associated with it.

If the name of the axis appears in red, it means that the PLC is inhibiting the movement of the axes (INHIBIT mark active).

B Active "M" functions.

C Active "G" functions and high-level commands.



CNC 8060
CNC 8065

(REF: 1402)

5.

MANUAL (JOG) MODE
Interface description.

- D** Tool related information. The information the CNC shows in this area depends on the model, lathe or mill.

At a mill model, the screen shows the number of the active tool "T", the active tool offset "D" for that tool and the number of the next tool "Nx vTool" and an icon representing the type of tool. The CNC also shows the radius and length of the active tool.

At a lathe model, the screen shows the number of the active tool "T", the active tool offset "D" for that tool and an icon representing the type of tool. The screen also shows the tool offsets on each axis.

- E** Information related to the feedrate "F" of the axes:

"F real" Actual feedrate of the axes.

"F prog" Programmed feedrate.

"F%" Percentage of feedrate override being applied on to the programmed value.

If the text "F real" appears in red, it means that the PLC is inhibiting the movement of the axes (`_FEEDHOL` mark active). The status of the mark is not displayed if the screen does not show this text.

- F** Information related to the spindle speed "S".

"S real" Actual spindle speed.

"S prog" Programmed speed.

"S%" Percentage of speed override being applied on to the programmed value.

Depending on the active screen, it will also show the spindle position "S pos" and its following error "S fwe".

The screen only shows the data on one spindle. If there are several spindles in the channel, the data on the next spindle may be displayed by pressing the "S" key twice (the first time to program a turning speed).

If the text "S real" appears in red, it means that the PLC is inhibiting the movement of the spindle (`INHIBIT` mark active). The status of the mark is not displayed if the screen does not show this text.

- G** Moving mode selected at the jog selector switch on the operator panel.

- H** Reserved.



CNC 8060
CNC 8065

(REF: 1402)





5.1.1 Softkey menus.

Horizontal softkey menu.

Softkey.	Description.
Home search.	Select the axes for a home search.
Preset coordinates.	Select the axes to preset a coordinate or move it to a coordinate.
MDI.	Access the MDI/MDA mode.
Turn the CNC off.	Start the CNC shut-down sequence, it is the same as pressing the key combination [ALT][F4].
Display.	Toggle between the different screens of the jog mode.

Vertical softkey menu.

The vertical softkey menu always shows all the options associated with this operating mode regardless of the active screen.

Softkey.	Description.
	Change the units for data display. The softkey highlights the units currently selected (millimeters or inches). The selected units are only valid for displaying data. For programming, the CNC assumes the units defined with the active function G70 or G71, or, when not programmed, the units set by the machine manufacturer (INCHES parameter). The CNC will display this softkey or not depending on how machine parameter MMINCHSOFTKEY has been set.
	Setting and activating the zero offsets and the fixture offsets. This softkey shows the zero offsets and the fixture offsets of the system, either to store the active zero offset or to activate a new zero offset.
	Tool calibration (.M- model). See chapter "6 Manual (jog) mode. Tool calibration".
	Tool calibration (.T- model). See chapter "6 Manual (jog) mode. Tool calibration".
	Part centering (.M- model).

5.

MANUAL (JOG) MODE
Interface description.



CNC 8060
CNC 8065

(REF: 1402)

5.2 Operations with the axes.

5.2.1 Home search.

Home search is the operation used to synchronize the system. This operation must be carried out when the CNC loses the position of the origin point (e.g. by turning the machine off).

When "searching home", the axes move to the machine reference point and the CNC assumes the coordinate values assigned to that point by the machine manufacturer, referred to machine zero. When using distance-coded reference marks or absolute feedback, the axes will only move the distance necessary to verify their position.

The axes may be homed manually (axis by axis from the operator panel) or automatically (using a subroutine).

Manual home search (one axis at a time).



The axis-by-axis home search cancels the zero offset, the fixture offset and the measuring offset. The CNC assumes the machine reference zero point (home) as the new part zero.

Home search via keyboard.

- 1 Select the axis to be homed using the alphanumeric keyboard. The CNC will highlight that axis to indicate that it is selected.

To select the numbered axes (e.g. "X1"), select any axis and then move the selection until positioning on the desired one. The focus moves with the [↑][↓] keys.



- 2 Press the homing key [ZERO]. The CNC will display the "1" symbol in the numeric area indicating that a home search will take place.
- 3 Press [START] to go ahead with the home search or [ESC] to cancel the operation.

Home search via softkey menu.

This operation is carried out one axis at a time. Home search of an axis is carried out as follows:

- 1 On the home search softkey of the horizontal menu, select the axis to be homed. The CNC will frame that axis and will display the "1" symbol in the numeric area indicating that a home search will take place.
- 2 Press [START] to go ahead with the home search or [ESC] to cancel the operation.

Automatic home search (with subroutine).

This homing method is only available if the machine manufacturer has previously defined a homing subroutine.

Home search via keyboard.



- 1 Press the homing key [ZERO]. The CNC will display a dialog box requesting confirmation to execute the home search.
- 2 Press [START] to go ahead with the home search or [ESC] to cancel the operation.

Home search via softkey menu.

- 1 On the home search softkey of the horizontal menu, select the "All" option. The CNC will display a dialog box requesting confirmation to execute the home search.
- 2 Press [START] to go ahead with the home search or [ESC] to cancel the operation.

5.

MANUAL (JOG) MODE
Operations with the axes.



CNC 8060
CNC 8065

(REF: 1402)

5.2.2 Jog

The axes may be jog using the JOG keyboard on the operator panel. The type of jog is selected with the jog selector switch on the operator panel.

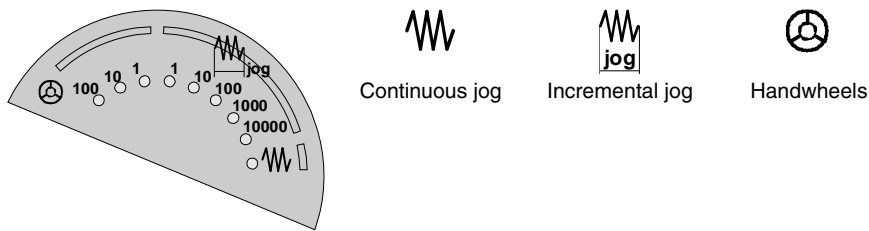

The jog keyboard and the feedrate selector

JOG keypad.

There are two types of jog keyboards depending on the behavior of the keys.

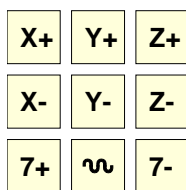

The keypad has two keys for each axis. One to jog the axis in the positive direction and another one to move it in the negative direction.

To move a single axis, press the axis key and the one for its jogging direction.

The keypad has a key for each axis and two keys for moving direction, common to all the axes.

To jog an axis requires activating both the axis key and the moving direction. There are two options, depending on how the jog keyboard has been configured.

- The axis will move while both keys are pressed, the axis key and the direction key.
- When pressing the axis key, the key remains active. The axis will move while the direction key is kept pressed. To de-select the axis, press [ESC] or [STOP].

User keys as jog keys

The CNC offers the OEM the possibility to enable the user keys as jog keys. The user keys defined this way behave like the jog keys.

Feedrate selector.

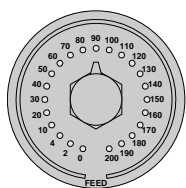

The movement is carried out at the feedrate defined by the OEM. The feedrate may be varied between 0% and 200% using the feedrate override switch on the operator panel.

5.

MANUAL (JOG) MODE
Operations with the axes.

Movement in continuous jog.

In continuous jog, the axes keep moving while the jog keyboard is acted upon. Continuous jog allows moving several axes at the same time.

- 1 Turn the jog selector switch of the operator panel to the continuous jog position on the dial.
- 2 Jog the desired axis using the JOG panel (keypad). If while moving, a second axis is selected and either the '+' key or the '-' key is pressed, the CNC stops the first axis and de-selects it. The new axis stays selected and moves according to the pressed '+' key or '-' key.



If while the axes are moving, the rapid key is pressed, the axes will move at the rapid rate set by the machine manufacturer. This feedrate will be applied while that key is kept pressed and, when released, the axes will recover their previous feedrate. This rapid rate may be varied between 0% and 200% with the feedrate override switch on the operator panel.

Movement in incremental jog.

In incremental jog, the axis moves a specific distance every time the key is pressed. In incremental jog, the axes may be jogged simultaneously.

- 1 Turn the jog selector switch of the operator panel to one of the incremental jog positions. Each position will move the axis a fixed distance; the typical values are the following.

Position.	Movement for each key push.
1	0.001 mm or 0.0001 inch.
10	0.010 mm or 0.0010 inches.
100	0.100 mm or 0.0100 inches.
1000	1.000 mm or 0.1000 inches.
10000	10.000 mm or 1.0000 inches.

- 2 Jog the desired axis using the JOG panel (keypad). Every time the JOG panel is acted upon, the axis will move the distance indicated on the dial of the jog selector switch. If while moving, a second axis is selected, the new one will move at the same time and under the same conditions.

5.

MANUAL (JOG) MODE
Operations with the axes.



CNC 8060
CNC 8065

(REF: 1402)

5.2.3 Jogging the axes with handwheels

Electronic handwheels may be used to move the axes. Depending on the type of handwheel, The CNC may have general handwheels to move any axis or individual handwheels that will only move their associated axes.

To move the axes with the handwheels, turn the jog selector switch of the operator panel to one of the handwheel positions. Every position indicates the multiplying factor applied to the handwheel pulses; the typical values are the following.

Position.	Movement per revolution of the handwheel.
1	0.100 mm or 0.0100 inches.
10	1.000 mm or 0.1000 inches.
100	10.000 mm or 1.0000 inches.

Once the desired resolution has been selected and depending on the type of handwheel being used, general or individual, proceed as follows.

General handwheel

The CNC may have several general handwheels. The general handwheel is not associated with any axis in particular, it may be used to move any axis of the machine even if it has an individual handwheel associated with it.

- If there are several axes selected in handwheel mode, the general handwheel will move all of them.
- If an axis has been selected which has an individual handwheel selected with it, this axis may be moved with the general handwheel, with the individual one or with both at the same time. When using both handwheels simultaneously, the CNC will add or subtract the pulses provided by both handwheels depending on which direction they are turned.
- If the CNC has several general handwheels, any of them can move the axes selected in handwheel mode. When using several handwheels simultaneously, each axis involved will be applied the sum of the increments of all the handwheels.

These are the steps to follow for moving one or several axes with the general handwheel.

- 1 Select the axis or axes to be jogged. The CNC will highlight the selected axes. When selecting an axis or quitting the handwheel mode using the movement selector, the previous one is automatically deselected.
- 2 Once the axis has been selected, the CNC will move it as the handwheel is turned depending on the setting of the selector switch and on the turning direction of the handwheel.

The feedrate depends on how fast the handwheel is turned.

Selecting the axes to be jogged

There are two ways to select the axes.

- 1 On the JOG keyboard, press one of the keys for the axis to be jogged. Selecting an axis de-selects the previous one. To select several axes, press one of the keys of each key at the same time.

An axis needs not belong to the active channel in order to be selected. An axis from one channel may be set in handwheel mode from another channel, if the channel of the axis is also in jog mode.

- 2 When using a handwheel with a push-button, the push-button may be used to select, sequentially, the axes to be jogged. Pushing the button selects the first one of the axes being displayed. If an axis has already been selected, it de-selects it and selects the next one. If it was the last one, it selects the first one again.

Only the axes being displayed in the active channel may be selected, regardless of the channel they belong to. The axes of another channel cannot be selected if they are not being displayed.

An axis is de-selected when quitting the handwheel mode using the movement selector and after a reset. If an axis has been set in handwheel mode from the PLC, it can only be deactivated from the PLC; a reset does not deactivate it.

5.

MANUAL (JOG) MODE
Operations with the axes.

FAGOR 

CNC 8060
CNC 8065

(REF: 1402)

Selecting an axis from the automatic mode

When having only one channel, if while in automatic mode, you set the switch in handwheel mode and select an axis, when going to jog mode, it maintains the selected axis.

Individual handwheel

The CNC can have several individual handwheels, where each of them is associated with a particular axis. The CNC moves each axis as its relevant handwheel is turned depending on the setting of the selector switch and on the turning direction of the handwheel.



In handwheel mode, this symbol next to an axis indicates that the axis has an individual handwheel associated with it.

When moving several axes simultaneously using handwheels, all the axes having their own handwheel plus the ones that may be selected with the general handwheel may be involved. When moving several axes at the same time, the feedrate of each axis depends on how fast its associated handwheel is turned.



It may happen that depending on the turning speed and the selector position, the CNC be demanded a faster feedrate than the maximum allowed. In that case, the CNC will move the axis the indicated distance but at the maximum feedrate allowed.

Feed handwheel.

Usually, when machining a part for the first time, the feedrate is controlled by the switch on the operator panel. The "feed handwheel" allows using one of the handwheels of the machine to control that feedrate depending on how fast the handwheel is turned.



This feature must be managed from the PLC. Usually, this feature is turned on and off using an external push button or key configured for that purpose.

5.

MANUAL (JOG) MODE

Operations with the axes.

5.2.4 Moving an axis to a particular position (coordinate)

Move an axis to a particular position (coordinate) via keyboard.

- 1 Select the axis to be moved using the alphanumeric keyboard. The CNC will highlight that axis to indicate that it is selected.
To select the numbered axes (e.g. "X1"), select any axis and then move the selection until positioning on the desired one. The focus moves with the [↑][↓] keys.
- 2 Enter the coordinate of the target point.
- 3 Press [START] to execute the movement or [ESC] to cancel the operation.

Move an axis to a particular position (coordinate) via softkey menu.

- 1 On the axis preset softkey of the horizontal menu, select an axis. The CNC will highlight that axis to indicate that it is selected.
- 2 Enter the coordinate of the target point.
- 3 Press [START] to execute the movement or [ESC] to cancel the operation.

Feedrate behavior

The moving feedrate depends on whether G00 or G01 is active. This feedrate may be varied between 0% and 200% using the feedrate override switch on the operator panel. The percentage will be applied on to all the movements carried out in G00 and in G01.

- If G00 is active, the movement is carried out at the rapid rate defined by the machine manufacturer.
- If G01 is active, the movement is carried out at the active feedrate. If no feedrate is active, the movement is executed at the feedrate defined by the machine manufacturer.

5.2.5 Coordinate preset

The coordinates must be preset one axis at a time. The preset may be canceled by homing the axes one by one or by means of function "G53".

Preset a position (coordinate) via keyboard.

- 1 Use the alphanumeric keyboard to select the axis whose position value (coordinate) is to be preset. The CNC will highlight that axis to indicate that it is selected.
To select the numbered axes (e.g. "X1"), select any axis and then move the selection until positioning on the desired one. The focus moves with the [↑][↓] keys.
- 2 Key in the desired preset value.
- 3 Press [ENTER] to preset the entered value or [ESC] to cancel the operation.

Preset a position (coordinate) via softkey menu.

- 1 On the axis preset softkey of the horizontal menu, select an axis. The CNC will highlight that axis to indicate that it is selected.
- 2 Key in the desired preset value.
- 3 Press [ENTER] to preset the entered value or [ESC] to cancel the operation.

5.

MANUAL (JOG) MODE
Operations with the axes.

FAGOR 

CNC 8060
CNC 8065

(REF: 1402)

5.3 Spindle control





Displaying the data of several spindles.

The screen only shows the data on one spindle. If there are several spindles in the channel, the data on the next spindle may be displayed by pressing the "S" key. The first push is to program the turning speed, the second one shows the data on the second spindle and so on.

Spindle control

The spindle may be controlled manually using the following keys of the operator panel. The keys always refer to the master spindle of the active channel.

The spindle speed should be set (in the MDI mode) before selecting the turning direction, thus avoiding a sudden start of the spindle when setting an "S" because the turning direction was active.

Key.	Meaning.
	Start the spindle clockwise (same as M03 function) at the active speed. The CNC shows the M03 function in the program history.
	Start the spindle counterclockwise (same as M04 function) at the active speed. The CNC shows the M04 function in the program history.
	Stop the spindle (same as M05 function). The CNC shows the M05 function in the program history.
	Orient the spindle (same as M19 function). The CNC shows the M19 function in the program history.

Vary the speed override from the operator panel.

With the operator panel, it is possible to change the percentage of spindle speed using a jog keyboard or a switch (depending on model).

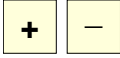
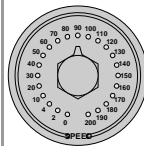
Key.	Meaning.
	Increases or decreases the percentage of spindle speed. The maximum and minimum values as well as the incremental step are set by the OEM, the typical values being a variation between 50% and 120% with a 5% step.
	It sets the percentage of turning speed to be applied. The maximum and minimum values are set by the OEM, the typical values being a variation between 50% and 120%.

5.

MANUAL (JOG) MODE
Spindle control



CNC 8060
CNC 8065

(REF: 1402)

5.4 Tool selection and tool change

The tool located in the spindle may be changed in manual mode. Proceed as follows.

- 1 Press [T] at the alphanumeric keyboard. The CNC will highlight the current tool indicating that it is selected.
- 2 Key in the number of the tool to be placed in the spindle.
- 3 Press [START] to execute the tool change or [ESC] to cancel the operation.

5.

MANUAL (JOG) MODE
Tool selection and tool change

FAGOR 

**CNC 8060
CNC 8065**

(REF: 1402)

5.5 Setting the feedrate and spindle speed.

5.

MANUAL (JOG) MODE

Setting the feedrate and spindle speed.

Setting a new feedrate in the channel.

The feedrate set in jog mode is only applied in that work mode and for the active channel. When setting a new feedrate in the MDI/MDA mode, it will become the new feedrate for the jog and automatic modes.

Follow these steps to set a new feedrate.

- 1 Press [F] at the alphanumeric keyboard. The CNC will highlight the relevant data indicating that it is selected.
- 2 Enter the new feedrate.
- 3 Press [START] to assume the entered value or [ESC] to cancel the operation.

Setting a new spindle speed.

The spindle speed set in the jog mode is applied to the spindle displayed at the time. If there are several spindles in the channel, the rest of the spindles may be displayed by pressing the [S] key. The spindle speed set in jog mode is maintained when switching to automatic mode and vice versa.

Follow these steps to set a new spindle speed.

- 1 Press [S] at the alphanumeric keyboard until selecting the desired spindle. When pressing this key for the first time, the CNC will highlight the relevant data indicating that it is selected.
- 2 Enter the new spindle speed.
- 3 Press [START] to assume the entered value or [ESC] to cancel the operation.



CNC 8060
CNC 8065

(REF: 1402)

5.6 Setting and activating the zero offsets and the fixture offsets.

In jog mode, it is possible to save the active offset in the zero offset table or in the fixture offset table (zero offset, coordinate presetting, etc.) and to activate a zero offset already defined in the tables.



This softkey shows the zero offsets and the fixture offsets of the system and their value in each axis of the channel. This list is a brief information of the zero offset tables and fixture offset tables and any change made in jog mode also affects those tables.

Loading a new zero offset or fixture offset into the table.

With an active offset, use the cursor to select an offset from the list and press [ENTER] to save the current offset in that zero offset. The position of all the axes of the channel are updated at the selected zero offset.

Applying a zero offset or fixture offset stored in the table.

Use the cursor to select a zero offset or fixture offset from the list and press the [START] key to activate. The new zero offset is applied to all the axes of the channel.

5.

MANUAL (JOG) MODE

Setting and activating the zero offsets and the fixture offsets.

FAGOR 

CNC 8060
CNC 8065

(REF: 1402)

5.

MANUAL (JOG) MODE

Setting and activating the zero offsets and the fixture offsets.





CNC 8060
CNC 8065

(REF: 1402)

MANUAL (JOG) MODE. TOOL CALIBRATION

6

Tool calibration is available in the jog mode. The softkey to access tool calibration will be different depending on the software installed (lathe model or mill model). To quit the calibration mode and return to jog mode, press the [ESC] key.

Softkey.	Type of calibration.
	Tool calibration in a mill model.
	Tool calibration in a lathe model.

The CNC offers in both models the possibility to calibrate lathe tools and milling tools. The CNC will show the necessary data and will update the help graphics according to the selected tool.

Types of calibration

There are several ways to calibrate a tool. Some ways are only available when using a table-top probe.



Only manual calibration is possible when not using a table-top probe. All types of calibration are available when using a table-top probe. The different calibration methods may be selected from the vertical softkey menu.

The active kinematics are taken into account and do not prevent tool calibration in this mode. Manual or semi-automatic calibration will not be possible if a coordinate (#CS or #ACS) transformation is active or when either the RTCP or TLC function is active.

Manual calibration. Calibration without a probe.

It is done without the table-top probe. A reference part is required to calibrate the tool. All the movements are carried out manually.

Semi-automatic calibration. Calibration with a probe.

This calibration mode is available when using a table-top probe. The positioning movements are carried out manually and the CNC executes the probing movements.

Automatic calibration. Calibration with a probe and a canned cycle.

This calibration mode is available when using a table-top probe. The CNC executes all the movements using the calibration canned cycle #PROBE.



CNC 8060
CNC 8065

(REF: 1402)

Probe selection

Two probes may be configured at the CNC. The probe active at the time is used for calibration. The active probe may be changed via part-program or MDI using the instruction #SELECT PROBE.

```
#SELECT PROBE [1]
  Selects the first probe.
#SELECT PROBE [2]
  Selects the second probe.
```

6.

MANUAL (JOG) MODE. TOOL CALIBRATION

Geometrical configuration of the axes on a lathe: "plane" or "trihedron".

At the lathe model, the geometrical configuration of the axes may be either of the "plane" or "trihedron" type depending on the availability of a third main axis, usually the ·Y· axis. The different calibration modes adapt to the current configuration showing the necessary data for each one of them.

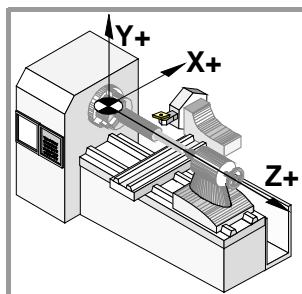

Geometrical configuration of "trihedron" type axes.

It is the typical configuration of a milling machine or of a lathe that has a third main axis (·Y· axis).

There are three axes forming a Cartesian XYZ type trihedron like on a milling machine. There may be more axes besides those forming the trihedron.

With this configuration, the planes behave in the same way as on a milling machine except that the usual work plane will be G18 (if it has been configured like that).

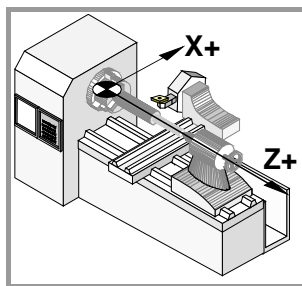

Geometrical configuration of "plane" type axes.

It is the typical configuration of a lathe.

There are two axes forming the usual work plane. There may be more axes, but they cannot be part of the trihedron; there must be auxiliary, rotary, etc.

With this configuration, the active plane will be formed by the first two axes defined in the channel. If the X (first) and Z (second) axes have been defined, the work plane will be the ZX (Z as abscissa and X as ordinate).

The work plane is always G18; the plane cannot be changed via part-program.

Configuration of "plane" type axes. The longitudinal axis.

In this configuration, the second axis of the channel is considered as longitudinal axis. If the X (first) and Z (second) axes have been defined, the work plane will be the ZX and Z will be the longitudinal axis. Tool length compensation is applied on this longitudinal axis when using milling tools. With lathe tools, tool length compensation is applied on all the axes where a tool offset has been defined.

When using milling tools on a lathe, the longitudinal compensation axis may be changed by means of the #TOOL AX instruction or the G20 function.



CNC 8060
CNC 8065

(REF: 1402)

6.1 Manual calibration. Calibration without a probe

In this mode, only the active tool can be calibrated and it may be a milling tool or a lathe tool. The CNC will show the necessary data and will update the help graphics according to the selected tool.

- Tool calibration window (-M- model).

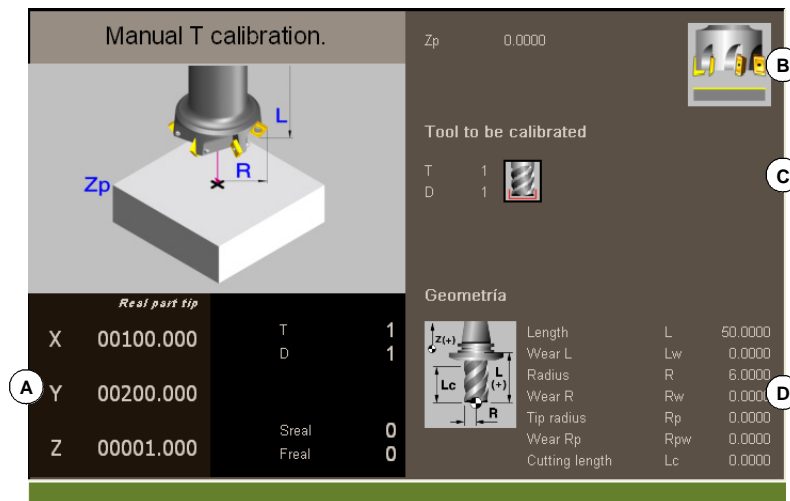

- Tool calibration window (-T- model).

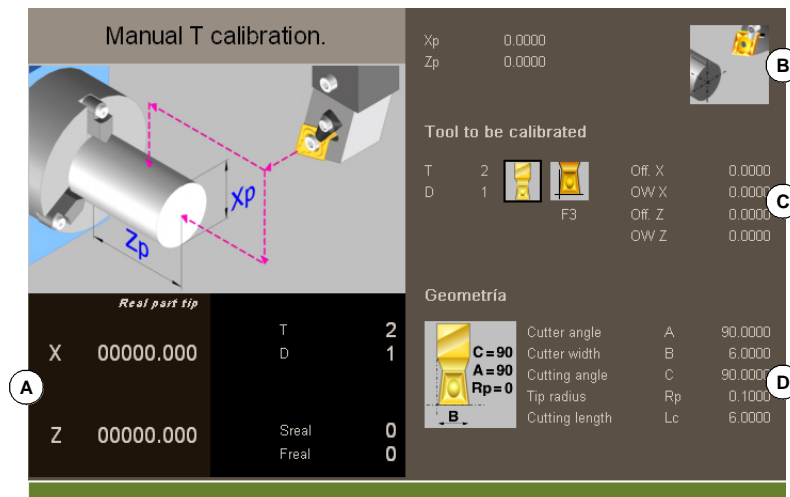

- A Machine data. Position of the axes, tool and active tool offset, real spindle speed and real feedrate of the axes.
- B Data of the part used for calibration and drawing showing that calibration is possible. If the window does not show this drawing, some of the data is missing.
- C Necessary data for calibration.
- D Tool data.

Tool calibration

Since there is no probe, a reference part is required to calibrate the tool. The calibration consists in moving the tool manually until it touches the part and then validating the calibration on each axis. After validating them, the new values are saved in the tool table.

Selecting a tool

The tool and the active tool offset may be changed from the calibration mode. After defining the new tool or tool offset in the cycle data, press [CYCLE START] and the CNC will execute the tool change.

Bear in mind that if the defined tool is the active tool, when pressing [START] the CNC assumes the values that the offset has at the time.

6.

MANUAL (JOG) MODE. TOOL CALIBRATION
Manual calibration. Calibration without a probe



CNC 8060
CNC 8065

(REF: 1402)

Calibration in a mill model

- On milling tools, the tool length is calibrated and the wear value is set to zero. The radius and radius wear may be set manually.
To calculate the length, it takes into account the coordinate of the longitudinal axis of the tool in the active plane (G17, G18, G19, G20), the tool orientation on the (#TOOL AX) axis and the coordinate of the reference part. For the calibration, it assumes that the coordinate of the reference part refers to the longitudinal axis of the tool.
- For the lathe tools, it calibrates the tool offsets on each axis. The offset wears are set to zero.

Tool calibration in a lathe model (Configuration of plane type axes).

For lathe and mill tools, it calibrates the tool offsets on each axis. When validating the calibration in one of the offsets, the wear of that offset is reset to zero.

Tool calibration in a lathe model (Configuration of trihedron type axes).

- For the lathe tools, it calibrates the tool offsets on each axis. When validating the calibration in one of the offsets, the wear of that offset is reset to zero.
- There are two options for the milling tools and may be selected with the following icons.





Tool length calibration. This option may be used to update the length value and resets the wear value to zero. It also updates the tool table data.



Tool offset calibration. This option may be used to update the value of the offsets on each axis. The offset wears are set to zero.

Validating the calibration.

They are validated from the vertical softkey menu. Once the tool has been calibrated, when pressing [START] the CNC assumes the new values of the offset.

Softkey.	Description.
	Validating the length calibration of a milling tool.
	Validating the offsets of a milling tool.
	Validating the offsets of a lathe tool.

When on a lathe the axis have a "trihedron" type configuration, the calibration on the axis perpendicular to the work plane is done using the horizontal softkey menu.

Definition of data

To define the data, place the focus on the relevant data, key in the desired value and press [ENTER].

For a lathe tool.

The nomenclature of the axes depends on the geometrical configuration of the "plane" or "trihedron" axes. For a "plane" configuration, the names of the axes assume the DIN standard for lathes; the Z axis as the abscissa axis and the X axis as the ordinate axis.

Data	Meaning
Zp Xp	Dimensions of the reference part being used in the calibration. These coordinates are referred to the main axes of the tool.
T	Tool to be calibrated.

6.

MANUAL (JOG) MODE. TOOL CALIBRATION
Manual calibration. Calibration without a probe



CNC 8060
CNC 8065

(REF: 1402)

Data	Meaning
D	Tool offset to be calibrated.
Off Y Off X	Tool offsets on each axis.
Lw	Offset wear on each axis.

When a lathe has a third axis perpendicular to the work plane ("trihedron" geometrical configuration), the CNC will also show its data and calibration will be possible on that axis. The data of the third axis may be hidden or shown using the horizontal softkey menu.

For a milling tool.

Data	Meaning
Zp	Coordinate of the reference part being used in the calibration. This coordinate is referred to the longitudinal axis of the tool.
T	Tool to be calibrated.
D	Tool offset to be calibrated.
L	Tool length.
Lw	Length wear.
R	Tool radius.
Rw	Radius wear.

Tool calibration steps

To calibrate the length, follow these steps.

- 1 Define the dimensions of the reference part being used in the calibration.
- 2 Select the tool and the offset to be calibrated. After the selection, the CNC shows the dimensions defined in the tool table for that offset.

To calibrate a tool, it must be the active tool. When selecting a tool and pressing [ENTER], the CNC only shows the data for that tool. Press [CYCLE START] for the CNC to make the tool change so it becomes the active tool. See *"Selecting a tool"* on page 119.
- 3 Calibrate the tool. Approach the tool manually until touching the part and then validate the calibration using the softkey menu.

After validating the calibration, it updates the values and initializes the wear value to zero. Then, the new values are saved in the tool table.
- 4 Press [START] for the CNC to assume the new values of the offset.

To calibrate another tool, repeat steps 2 and 3.

Considerations for the offsets and their wear.

It must be borne in mind that the offset of a tool on an axis is the distance between the base of the tool and its tip (nose). This means that when calculating the offset of a milling tool on an axis that includes the radius dimension, that radius is included in the offset. The same is true for the tool length.

When calibrating the offsets of a milling tool, the length value is deleted but not the radius value.

Sign criteria for the offsets and their wear.

The sign criterion for the offsets and their wear is established by machine parameter TOOLOFSG.

TOOLOFSG	Meaning.
Negative.	Tool calibration returns a negative offset. The offset wear must be entered with a positive value.
Positive.	Tool calibration returns a positive offset. The offset wear must be entered with a negative value.



CNC 8060
CNC 8065

(REF: 1402)

Entering wear values incrementally or absolutely.

In the tool table, it is possible to define whether the wear value being entered must be incremental or absolute. See *"Select the type of wear values to enter, incremental or absolute."* on page 255.

Using incremental wear, the value entered by the user will be added (or subtracted if it is negative) to the absolute value of the wear. After pressing [ENTER] to accept the new value, the wear field will show the resulting absolute value.

Initial wear	Incremental wear	Total wear
1	0.2	1.2
1	-0.2	0.8
-1	0.2	-0.8
-1	-0.2	-1.2

6.

MANUAL (JOG) MODE. TOOL CALIBRATION
Manual calibration. Calibration without a probe



CNC 8060
CNC 8065

(REF: 1402)

6.2 Semi-automatic calibration. Calibration with a probe

This option is only available when using a tabletop probe installed on the machine.

On a milling model, it may be used to calibrate the length and radius of the milling tools and the offsets of the lathe tools. On a lathe model, it may be used to calibrate the offsets of any tool.

- Tool calibration window (-M- model).

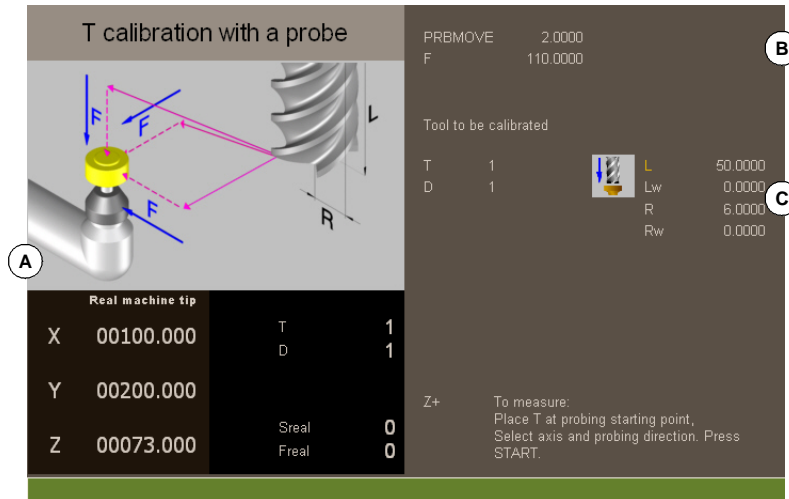

- Tool calibration window (-T- model).

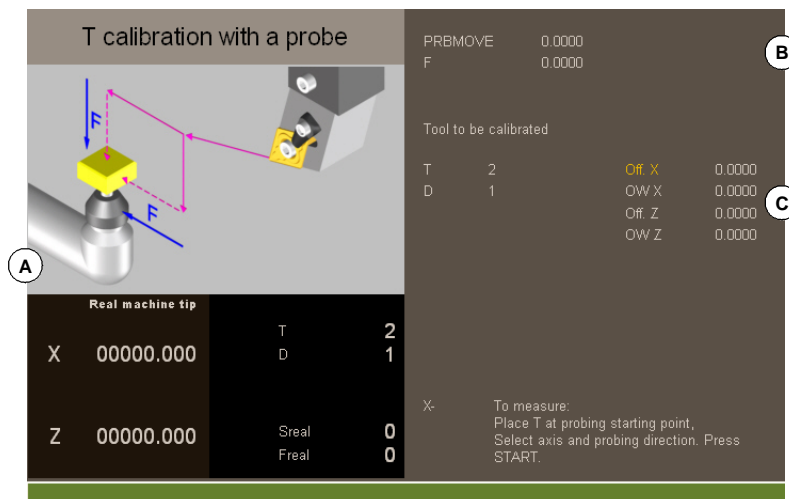

A Machine data. Position of the axes, tool and active tool offset, real spindle speed and real feedrate of the axes.

B Data of probing movement.

C Necessary data for calibration.

The tool must be in the spindle. After the calibration, the wear is reset to zero.

When changing the tool data, the tool table data is updated after calibration.

Tool calibration

The calibration consists in manually approaching the tool to the probe and then command the CNC to execute the probing movement. The CNC will move the tool on the selected axis until touching the probe. After touching the probe, it concludes the calibration on that axis and updates the values.

Selecting a tool

The tool and the active tool offset may be changed from the calibration mode. After defining the new tool or tool offset in the cycle data, press [CYCLE START] and the CNC will execute the tool change.

6.

MANUAL (JOG) MODE. TOOL CALIBRATION
Semi-automatic calibration. Calibration with a probe

FAGOR 

CNC 8060
CNC 8065

(REF: 1402)

Bear in mind that in this calibration mode, the [CYCLE START] key has two functions. If a new tool has been selected, it executes the tool change. If the selected tool is the active one, pressing [CYCLE START] initiates the calibration.

Calibration in a mill model

On milling tools, it calibrates the radius and length of the tool. After calibrating one of the two dimensions, its wear value is reset to zero.

For the lathe tools, it calibrates the tool offsets on each axis. The offset wears are set to zero.

Calibration in a lathe model

For the lathe tools, it calibrates the tool offsets on each axis. When validating the calibration in one of the offsets, the wear of that offset is reset to zero.

Validating the calibration

Use the horizontal softkey menu to select the axis and the moving direction for the calibration. Once selected and after placing the tool in the spindle, press [CYCLE START] to start the calibration. The tool will move in the indicated direction until touching the probe and it will then conclude the calibration updating the tool data with the measured values.

Once the tool has been calibrated, the CNC shows a message proposing to press [START] so the CNC assumes the new values of the offset. When pressing [START] while this message is displayed, the CNC assumes the new values of the offset; if the message is not displayed, pressing [START] executes the probing movement again.

Once a movement has been selected, the window will show a help drawing indicating the type of calibration to be done, length or radius.

Definition of data

To define the data, place the focus on the relevant data, key in the desired value and press [ENTER].

Data	Meaning
PRBMOVE	Maximum probing distance. If the CNC does not receive the probe signal before reaching moving this probing distance, it stops the axes.
F	Probing feedrate.
T	Tool to be calibrated.
D	Tool offset to be calibrated.
L	Tool length.
Lw	Length wear.
R	Tool radius.
Rw	Radius wear.

Tool calibration steps

To calibrate the tool, follow these steps:

- 1 Define the probing distance and feedrate. If the feedrate is not defined, the probing movement will be made at the feedrate set by the OEM.
- 2 Select the tool and the offset to be calibrated. After the selection, the CNC shows the dimensions defined in the tool table for that offset.

To calibrate a tool, it must be the active tool. When selecting a tool and pressing [ENTER], the CNC only shows the data for that tool. Press [CYCLE START] for the CNC to make the tool change so it becomes the active tool. See "[Tool calibration](#)" on page 119.

- 3 Manually approach the tool to the probe until it is placed on the path that will be used for probing. To calibrate the radius with a cylindrical probe, the path must coincide with the probe's center point; if not, the radius will be calculated wrong.

6.

MANUAL (JOG) MODE. TOOL CALIBRATION
Semi-automatic calibration. Calibration with a probe



CNC 8060
CNC 8065

(REF: 1402)

- 4 Calibrate the tool. Select the axis and the probing direction on the softkey menu and press [START].

The probe moves in parallel to the axis and in the selected direction until touching the probe. It updates the measured value and resets the wear value to zero. The data is stored in the tool table.

- 5 Press [START] again for the CNC to assume the new values of the offset. For the new values to be assumed, press [START] while the bottom message is displayed; otherwise, it executes the probing movement again.

Considerations for the offsets and their wear.

It must be borne in mind that the offset of a tool on an axis is the distance between the base of the tool and its tip (nose). This means that when calculating the offset of a milling tool on an axis that includes the radius dimension, that radius is included in the offset. The same is true for the tool length.

When calibrating the offsets of a milling tool, the length value is deleted but not the radius value.

Sign criteria for the offsets and their wear.

The sign criterion for the offsets and their wear is established by machine parameter TOOLOFSG.

TOOLOFSG	Meaning.
Negative.	Tool calibration returns a negative offset. The offset wear must be entered with a positive value.
Positive.	Tool calibration returns a positive offset. The offset wear must be entered with a negative value.

Entering wear values incrementally or absolutely.

In the tool table, it is possible to define whether the wear value being entered must be incremental or absolute. See ["Select the type of wear values to enter, incremental or absolute."](#) on page 255.

Using incremental wear, the value entered by the user will be added (or subtracted if it is negative) to the absolute value of the wear. After pressing [ENTER] to accept the new value, the wear field will show the resulting absolute value.

Initial wear	Incremental wear	Total wear
1	0.2	1.2
1	-0.2	0.8
-1	0.2	-0.8
-1	-0.2	-1.2

6.

MANUAL (JOG) MODE. TOOL CALIBRATION
Semi-automatic calibration. Calibration with a probe



CNC 8060
CNC 8065

(REF: 1402)

6.3 Automatic calibration with a probe and a canned cycle

6.3.1 Mill or lathe model ("trihedron" geometrical configuration)

This option is only available when using a tabletop probe installed on the machine. This mode may be used to calibrate both milling and lathe tools. The CNC will show the necessary data and will update the help graphics according to the selected tool.

6.

MANUAL (JOG) MODE. TOOL CALIBRATION
Automatic calibration with a probe and a canned cycle

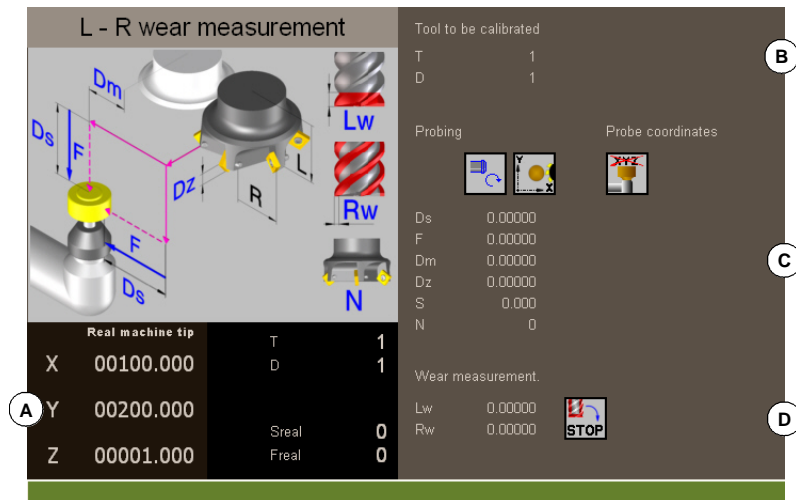

- A Machine data. Position of the axes, tool and active tool offset, real spindle speed and real feedrate of the axes.
- B Tool to be calibrated.
- C Data for probe calibration and position.
- D Data for tool wear measurement.

Tool calibration

The calibration is done using a probing canned cycle. The CNC moves the tool until touching the probe and validates the calibration on each axis. The tool may be calibrated on both axes of the plane or on the three axes of the trihedron.

The calibration begins when pressing the [CYCLE START] key. When the CNC finishes the calibration on the selected axes, it updates the tool table with the measured values. Also, the CNC assumes the new values.

Selecting a tool

In this calibration mode, the cycle itself changes the tool and the tool offset. There is no need to previously place the tool in the spindle.

Bear in mind that pressing the [CYCLE START] key starts the calibration cycle.

Select another position for the probe.



The calibration uses the probe position defined in the machine parameters. Optionally, another position may be defined for the probe which will only be valid for the defined calibration. The new position does not affect the values defined in the machine parameters.

Tool calibration

There are two options for the milling tools and may be selected with the following icons.



- Calibrate the offsets and resets the wears to zero.



- Calibrate the length and radius and measure the wears.

For the lathe tools, it calibrates the tool offsets on each axis. The offset wears are set to zero.



CNC 8060
CNC 8065



(REF: 1402)

Definition of data

To define the data, place the focus on the relevant data, key in the desired value and press [ENTER]. To change icons, place the focus on it and press [SPACE].

To calibrate the length, radius and wears of a milling tool.

The data shown depends on the calibration option selected with the horizontal softkey menu. This menu may be used to select the length and/or radius calibration and whether to calculate their wear or not. If the wears are not calculated, they are reset to zero after the calibration.

Data	Meaning
T	Tool to be calibrated.
D	Tool offset to be calibrated.
Ds	Safety distance.
F	Probing feedrate. If not defined, the movements are carried out at the default feedrate, set by the machine manufacturer.
N	Number of cutters of the tool. If defined with a $\cdot 0\cdot$ value, the CNC knows the location of a cutter and it will only make the movement once. The spindle turning speed must be $\cdot 0\cdot$. If defined with a value other than $\cdot 0\cdot$, all cutters will be calibrated. The CNC makes an initial movement to locate a cutter; then, stops the spindle and makes a precise measurement of each cutter. It is necessary to define the spindle speed and the Dm distance.
Dm	Distance the edge of the tool separates from the center of the probe to position the next cutter.
S	Spindle speed.
	Probe side to be touched.
 	Behavior when exceeding the maximum wear permitted; reject the tool or change it with another one from the same family.
Lw	Maximum length wear allowed.
Rw	Maximum radius wear allowed.
PRB1MAX ... PRB2MIN	Probe position. The values defined here are only taken into account during the calibration cycle; they do not modify the machine parameter values.

To calibrate the offsets of a milling or lathe tool.

Data	Meaning
T	Tool to be calibrated.
D	Tool offset to be calibrated.
Ds	Safety distance.
F	Probing feedrate. If not defined, the movements are carried out at the default feedrate, set by the machine manufacturer.
PRB1MAX ... PRB2MIN	Probe position. The values defined here are only taken into account during the calibration cycle; they do not modify the machine parameter values.
	This icon sets the number of axes to calibrate on.

6.

MANUAL (JOG) MODE. TOOL CALIBRATION
Automatic calibration with a probe and a canned cycle

FAGOR 

CNC 8060
CNC 8065

(REF: 1402)

Tool calibration steps

To calibrate the length, follow these steps.

- 1 Select the tool and the offset to be calibrated. It is not necessary to insert the tool into the spindle; the CNC carries out this operation if necessary.
- 2 Define the data defining the calibration. To calibrate a milling tool, use the horizontal softkey menu to select the desired operation.
- 3 Press the [CYCLE START] key to start the calibration. The CNC calibrates the tool making all the necessary movements; there is no need to manually approach the tool. If necessary, the CNC makes the tool change.
- 4 After the calibration It updates the tool table data.

6.**MANUAL (JOG) MODE. TOOL CALIBRATION**

Automatic calibration with a probe and a canned cycle



CNC 8060
CNC 8065

(REF: 1402)

6.3.2 Lathe model ("plane" geometrical configuration)

This option is only available when using a tabletop probe installed on the machine. This mode may be used to calibrate both milling and lathe tools. The CNC will show the necessary data and will update the help graphics according to the selected tool.

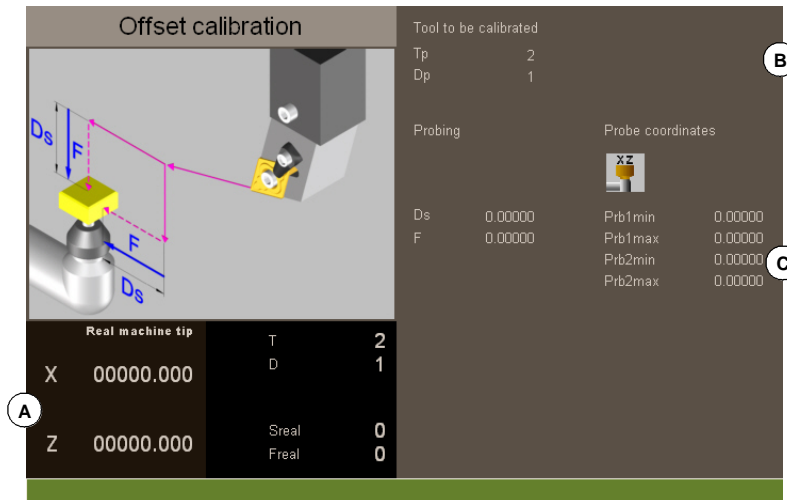

- A Machine data. Position of the axes, tool and active tool offset, real spindle speed and real feedrate of the axes.
- B Tool to be calibrated.
- C Data for probe calibration and position.

Tool calibration

The calibration is done using a probing canned cycle. The CNC moves the tool until touching the probe and validates the calibration on each axis. The tool is calibrated on the two axes of the plane.

The calibration begins when pressing the [CYCLE START] key. When the CNC finishes the calibration on the selected axes, it updates the dimensions and the wears. Then, the new values are saved in the tool table.

Selecting a tool

In this calibration mode, the cycle itself changes the tool and the tool offset. There is no need to previously place the tool in the spindle.

Bear in mind that pressing the [CYCLE START] key starts the calibration cycle.

Select another position for the probe.



The calibration uses the probe position defined in the machine parameters. Optionally, another position may be defined for the probe which will only be valid for the defined calibration. The new position does not affect the values defined in the machine parameters.

Tool calibration

For milling and lathe tools, it calibrates the tool offsets on each axis. The offset wears are set to zero.

6.

MANUAL (JOG) MODE. TOOL CALIBRATION
Automatic calibration with a probe and a canned cycle



CNC 8060
CNC 8065

(REF: 1402)

Definition of data

To define the data, place the focus on the relevant data, key in the desired value and press [ENTER]. To change icons, place the focus on it and press [SPACE].

Data	Meaning
T	Tool to be calibrated.
D	Tool offset to be calibrated.
Ds	Safety distance.
F	Probing feedrate. If not defined, the movements are carried out at the default feedrate, set by the machine manufacturer.
PRB1MAX ... PRB2MIN	Probe position. The values defined here are only taken into account during the calibration cycle; they do not modify the machine parameter values.

Tool calibration steps

To calibrate the length, follow these steps.

- 1 Select the tool and the offset to be calibrated. It is not necessary to insert the tool into the spindle; the CNC carries out this operation if necessary.
- 2 Define the data defining the calibration.
- 3 Press the [CYCLE START] key to start the calibration. The CNC calibrates the tool making all the necessary movements; there is no need to manually approach the tool. If necessary, the CNC makes the tool change.
- 4 After the calibration It updates the tool table data.

6.

MANUAL (JOG) MODE. TOOL CALIBRATION

Automatic calibration with a probe and a canned cycle



CNC 8060
CNC 8065

(REF: 1402)

MANUAL (JOG) MODE. PART CENTERING (MILL MODEL)

7

Part centering is available in the jog mode. This option is only available at the mill model. To quit the part centering mode and return to jog mode, press the [ESC] key.



This mode may be used to calculate the center of a rectangular or circular part of known dimensions as well as, in rectangular parts, the inclination of the part with respect to the abscissa axis. The type of part to be centered is selected with the parameters of the cycle.

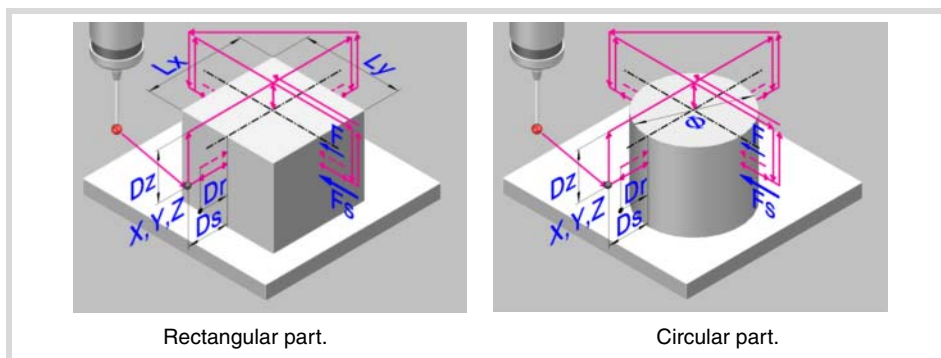

Requirements prior to the calibration.

To execute this cycle, the probe must be properly calibrated. Before executing the cycle, the probe must be placed near the part and in front of the probing point, as centered as possible and in the Z coordinate where probing will take place.

Requirements prior to the calibration.

To center the part, follow these steps.

- 1 Select the probe and the offset. If not selected, the probe to be used must be defined in the parameters of the cycle.
- 2 Enter the data of the cycle.
- 3 Press the [START] key to start the cycle. The CNC makes the necessary moves to center the part.
- 4 When done with the cycle, the CNC updates the corresponding parameters.

Data returned by the cycle after the measurement.

Once the cycle has ended, the CNC returns the real values obtained in the measurement in the following arithmetic parameters:

- P296 Inclination angle between the part and the abscissa axis (rectangular part).
P297 Part surface coordinate.
P298 Part center coordinate along the abscissa axis.
P299 Part center coordinate along the ordinate axis.

Optionally, in this cycle, it is possible to preset the coordinates to select a new part zero and, in rectangular parts, rotate the coordinate axes to align the axes with the part.



CNC 8060
CNC 8065

(REF: 1402)

7.1 How to define the data.

To enter or modify a data, it must be selected; i.e. it must have the editing focus on it. The parameters of the cycles may be selected with the [←] [→] [↑] [↓] keys or with the direct access keys. The first data of each group may also be selected by pressing the page-up and page-down keys.

The direct access keys correspond to the name of the parameters; [F] for feedrates, [T] for tools, etc. Every time the same key is pressed, it selects the next data of the same type.

7.

Manual data entry.

To modify a numerical data, key in the desired value or press [DEL] to leave the data undefined. In either case, press [ENTER] for the cycle to assume the new value.

Press the [SPACE] key to change the status of this icon.

Leaving some data undefined.

Some data may be left undefined (empty checkbox). In this case, the cycle behaves as follows.

- If the cycle position is not defined, it is executed at the current position the axes when calling the cycle.
- If the tool number is not defined, it will be executed with the tool that is active at the time of execution.

Defining data using arithmetic parameters..

Numerical data may be defined using global arithmetic parameters (P100-P9999) or common ones (P10000-P19999). In this case, when executing the cycle, these data will assume the value that the parameter has at the time.

When using global parameters, bear in mind that some cycles modify the value of these parameters at the end of the execution. Refer to each cycle to see which parameters it modifies.

Teach-in mode for data entry.

The Teach-in mode is always active and the bottom of the screen shows a window with the axes of the channel. The Teach-in mode may be used to jog the axes and assign their current position to the data that define the position of the cycle. The axes may be jogged using the jog keypad, the handwheels or via MDI.

To assign a value to a data, select it with the cursor (focus on it) and press the [RECALL] key. The data is taken from the channel where the part centering mode is active.

- The X axis related data takes the coordinate of the first axis of the channel.
- The Y axis related data takes the coordinate of the second axis of the channel.
- The Z axis related data takes the coordinate of the third axis of the channel.

7.2 Data programming.

Probe data.

·Tp· Number of the tool that identifies the probe.

Number of the tool used to define the probe in the tool table. Optional parameter, if not defined or set to 0, use the probe that is in the spindle when executing the cycle.

·Dp· Number of the tool offset that identifies the probe.

Offset associated with the probe, used to execute the cycle.

Probing movement.

·X Y Z· Probe position to execute the cycle.

Xm Probe position along the abscissa axis

Ym Probe position along the ordinate axis.

Zm Probe position along the axis perpendicular to the plane.

The part centering cycle is executed in the active plane.

·icon· Geometry of the part to be centered.

This parameter indicates the type of part to be centered.



Rectangular part centering.



Circular part centering.

·icon· Axis and direction of the first probing movement.

This parameter sets the axis on which the first probing movement will take place.

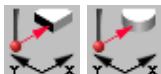

The probe moves in the positive direction of the X axis.



The probe moves in the negative direction of the X axis.



The probe moves in the positive direction of the Y axis.



The probe moves in the negative direction of the Y axis.

·icon· Surface coordinate measuring.

This parameter indicates whether the cycle must also measure the position of the top surface of the part.



The cycle does not measure the surface coordinate.



The cycle measures the surface coordinate.

·icon· Preset the part zero after ending the cycle.

This parameter indicates whether the part zero is to be preset or not, if so, the point taken as reference. This point may be preset with any value using parameters ·Px Py Pz·.



Do not preset the part zero.



Preset the part zero at the center of the part.



Preset the part zero at one of the corners (the cycle shows an icon for each corner).

·icon· Pattern rotation.

For rectangular parts, this parameter indicates whether a coordinate rotation is to be applied or not with the measured angle.



Do not rotate the coordinates (pattern).



Rotate the coordinates (pattern).

·Lx Ly Ø· Part dimensions.

These parameters establish the dimensions of the rectangular or circular part.

Lx Rectangular part. Part length along the abscissa axis.

Ly Rectangular part. Part length along the ordinate axis.

Ø Circular part. Part diameter.

For a rectangular part, parameters ·Lx· and ·Ly· indicate the length of the pocket on each axis. The sign indicates tool orientation.

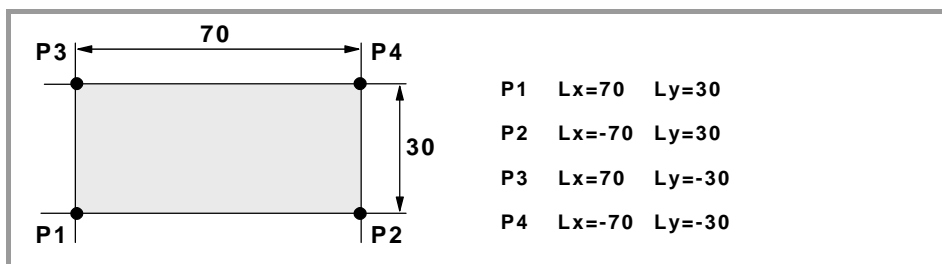

·Ds· Safety distance.

Optional parameter; if not defined, it assumes the distance between the part and the probe position when calling the cycle.

Distance with respect to the point to measure, to which the probe approaches before making the probing movement.

·Dr· Withdrawal distance after initial probing.

This parameter sets the distance the probe withdraws after the first probing movement. Once it withdraws this distance, the CNC makes a second probing movement.

·Dz· Safety distance along Z.

Distance for the probe to go up for its movements over the part.

·Fs· Feedrate for the first probing movement.

Optional parameter; if not defined, the cycle assumes the value of machine parameter PROBEFEED of the axis.

This parameter sets the feedrate for the first probing movement. Then, the CNC will repeat the probing movement at feedrate ·F·.

7.



CNC 8060
CNC 8065

(REF: 1402)

·F· Probing feedrate.

Optional parameter; if not defined, the cycle assumes 10% of the value of machine parameter PROBEFEED of the axis.

This parameter sets the feedrate for the second probing movement.

·icon· Feedrate for approach movements.

This parameter sets the type of feedrate for the movements to the approach points.



The movements are carried out in rapid.



The movements are carried out at work feedrate.

Coordinate preset value.

·Px Py Pz· Coordinate preset value on each axis.

Px Preset value on the abscissa axis.

Py Preset value on the ordinate axis.

Pz Preset value on the axis perpendicular to the plane.

These parameters are only valid when presetting the part zero and any this point may be assigned any value.

7.3 Basic operation.

7.

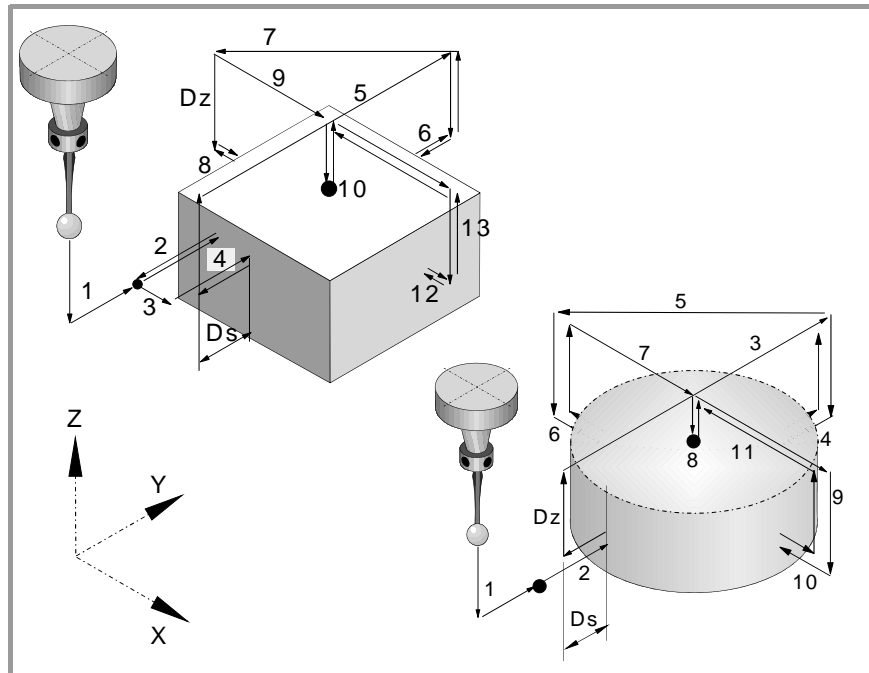
MANUAL (JOG) MODE. PART CENTERING (MILL MODEL)
Basic operation.

- 1 Approach movement (if any of parameters $\cdot XYZ \cdot$ has been defined).

Movement of the probe at the selected feedrate from the cycle calling point to the first approach point defined by parameters $\cdot XYZ \cdot$.

This approach movement is made in two stages. It first moves in the work plane and then along the axis perpendicular to the plane.

- 2 Probing of the first point

The cycle makes a first probing movement, a withdrawal movement and a second probing move. After the second probing move, the probe withdraws to the approach point.

First probing movement. Probe movement along the selected axis at feedrate $\cdot Fs \cdot$ until the probe signal is received.

Withdrawal movement. Return of the probe in rapid (G00) the distance indicated in $\cdot Dr \cdot$.

Second probe. Probing movement at feedrate $\cdot F \cdot$ until the probe signal is received.

Withdrawal movement. Rapid probe movement (G00) from the probing point to the starting point.

- 3 If it is a rectangular part, approach movement for calculating the inclination.

Movement parallel to the probed side to touch a different point of the same side.

- 4 If it is a rectangular part, probing movement to calculate the inclination of the part.

Probing movement at feedrate $\cdot F \cdot$ until the probe signal is received. The probe returns to the safety position located at a $\cdot Ds \cdot$ distance from the part.

- 5 Approach movement to the second probing point.

Movement of the probe from the first approach point to the second located in front of the first one.

The perpendicular axis moves the $\cdot Dz \cdot$ distance up in rapid (G00). Then the probe moves over the part, at the selected feedrate, to the next approach point. The probe moves a $\cdot Dz \cdot$ distance back down at feedrate $\cdot Fs \cdot$

For the movement, the cycle takes into consideration the dimensions of the part and, if it is rectangular, its inclination angle. If in this last movement, the probe touches the part, the CNC shows an error at the cycle parameter value.

- 6 Probing of the second point.

It is done like the previous one. The probe returns to the safety position located at a $\cdot Ds \cdot$ distance from the part.

- 7 Approach movement to the third probing point.

Movement of the probe from the second approach point to the third.

CNC 8060
CNC 8065

(REF: 1402)

8 Probing of the third point.

It is done like the previous one.

9 Approach movement to the top surface (only if it has been programmed).

When selecting to measure the surface, the probe moves the $\cdot Dz \cdot$ distance up in rapid (G00) and the probe moves to the center of the part.

10 Measuring the top surface (only if it has been programmed).

The probe makes a first probing move, a withdrawal movement and a second probing move. After the second probing move, the probe withdraws to the approach point.

First probing movement. Probing movement, at feedrate $\cdot Fs \cdot$, until touching the part surface.

Withdrawal movement. Return of the probe in rapid (G00) the distance indicated in $\cdot Dr \cdot$.

Second probe. Probing movement at feedrate $\cdot F \cdot$ until the probe signal is received.

Withdrawal movement. Rapid probe movement (G00) from the probing point to the safety position.

11 Approach movement to the fourth probing point.

Movement of the probe from the third approach point to the fourth.

12 Probing of the fourth point.

It is done like the previous one.

13 Probe positioning at the calculated center.

This movement is carried out in two stages. It first moves along the perpendicular axis in rapid (G00) and then in the plane.

7.

MANUAL (JOG) MODE. PART CENTERING (MILL MODEL)

Basic operation.



CNC 8060
CNC 8065

(REF: 1402)

7.

MANUAL (JOG) MODE. PART CENTERING (MILL MODEL)

Basic operation.



CNC 8060
CNC 8065

(REF: 1402)

EDISIMU MODE (EDITING AND SIMULATION)

8

Program editor, Unicode format.

The editor of the CNC admits Unicode characters. When saving a program, the editor respects its original format, ANSI or Unicode, except when editing a Unicode character, in which case the CNC will always save the program in Unicode format.



Programs in Unicode format are not compatible with versions older than V4.0. A program in Unicode format cannot be edited or executed in a version older than V4.0.

A third-party text editor (like Windows notepad) may be used to convert Unicode format programs into ANSI format; but special characters that have no ANSI equivalent will be lost in the process.

8.1 Interface description.

On a typical screen for this work mode, the information is laid out as follows.

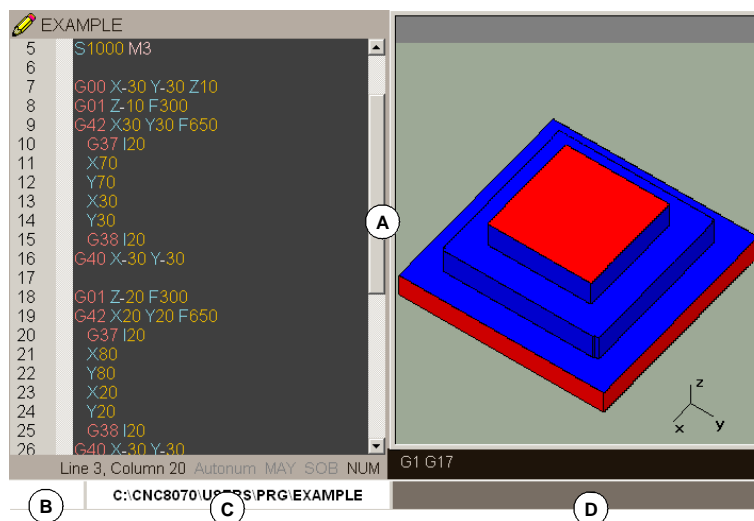

- A** Windows of the EDISIMU mode. Every screen may consist of one or more windows.
- B** Status of the program selected in this work mode or channel number when using them. In any case, the background color will be different depending on the status of the program being simulated.

Ready	Background color: White.
In simulation	Background color: Green.
Interrupted	Background color: Dark green.
In error	Background color: Red.
- C** Program name and location.
- D** CNC messages.



CNC 8060
CNC 8065

(REF: 1402)

Window description

As mentioned earlier, each screen may consist of one or many of the following windows (later sections of this chapter describe each one of them in greater detail):



When the screen consists of several windows, the softkey menu will show the options of the active window. To switch windows and access the desired softkey menu, press the [FOCUS] key.

- **Edit window:** For editing new programs or modify the existing ones. Editing is possible using a profile editor, a conversational canned cycle editor or using the TEACH-IN feature.
- **Graphic window:** This window shows a graphic representation of the program during the simulation. It also allows taking measurements on the graphics.
- **Program window:** For selecting the starting and ending conditions of the simulation.
- **Statistics window:** For estimating the machining time for each tool and the total program execution time.
- **Cycle editor.** The cycle editor makes it easier to edit machining and probing cycles.
- **Profile editor.**
- **Editor for inclined planes.**
- **Geometric help editor.**

8.

EDISIMU MODE (EDITING AND SIMULATION)

Interface description.











CNC 8060
CNC 8065

(REF: 1402)

8.1.1 Softkey menus.

Vertical softkey menu.

The vertical softkey menu always shows all the options associated with this operating mode regardless of the active screen.

Softkey.	Description.
	Show more options on the softkey menu.
	START (simulation) Starts program simulation or resume it if it was interrupted. During simulation, the graphic window will show the graphic representation of the program being simulated.
	STOP (simulation) Interrupt program simulation. Simulation will resume by pressing the START icon.
	RESET (simulation) Cancel program simulation. If an error occurs during simulation, reset eliminates the error status and returns the simulation mode to its initial conditions.
	Change the channel being displayed for editing and simulation. It does not affect the active channel at the CNC. (This icon will only be available when using channels).
	Select the "single block" or "continuous" mode; either one may be selected even while executing a program. When "single block" mode is active (the icon will appear pressed), program simulation will be interrupted at the end of each block. When the "automatic" mode is active, the simulation will take place until the end of the program or up to the block selected as end of simulation.
	Analyze the program looking for syntax errors. The syntax check is not available for programs written in 8055 CNC language. If there are no errors, the bottom of the screen will display a message indicating that the program is correct. If there are syntax errors, they will be shown at the bottom of the editing window.
	Offer an estimate of the total execution time at 100% of the programmed feedrate. The result will appear at the statistics window. (This icon is only available when the statistics window is displayed).
	Configuring simulation options. <ul style="list-style-type: none"> • Activate and cancel tool radius compensation. • Conditional stop. • Activate and deactivate the software travel limits. • Block skip condition. • Cancel the channel synchronization in the simulation.



8.2 Program editing and simulation

8.2.1 Program editing

The process of editing or modifying a program is the following:

- 1 Open the program at the editor or create a new program.
- 2 Use the cursor to select the block where the new blocks will be inserted. Edit the program blocks using the editing modes available.
- 3 Save the program so it can be modified or executed later on. This operation may be performed automatically as the program is being edited or if the editor has been personalized.

Available editing modes

Any of the various editing modes available may be used while editing a program. The available editing modes are:

CNC language

It is edited block by block and each one may be written in ISO language or in High level language. When editing high level commands and depending on the type of command, the editor offers a list of available commands. See "[8.3.2 Contextual programming assistance.](#)" on page 147.

8055 CNC language

Part-programs may be edited in the CNC's own language and in the 8055 language. The 8055 CNC programming language is enabled at the part-program editor using the "Customize" softkey of the horizontal menu. Within this option, activate the softkey of the 8055 editor. See "[8.2.2 Editing a program in the 8055 CNC language](#)" on page 139.

Canned cycle editor

With this editor, it is possible to define machining and probing canned cycles quickly and easily. When done editing the cycle, the CNC generates the necessary blocks and it will add them to the program inserting them after the block indicated by the cursor. This mode offers the following advantages:

- There is no need to know the canned cycle parameters.
- The CNC only lets entering the data being shown, thus avoiding any data entry errors when defining the cycles.
- The programmer is assisted at all times with help messages.

Profile editor

With this editor it is possible to edit new profiles quickly and easily. The editor shows a graphic representation of the profile being defined. After defining the profile data, the CNC generates the necessary blocks and it will add them to the program inserting them after the block indicated by the cursor.

Inclined planes (-M- model only)

Help to the user for programming inclined planes using the instructions #CS and #ACS. Using the "Insert" softkey, the block corresponding to the programmed instruction is inserted after the block where the cursor is.

Geometric help (-M- model only)

Assistance to the user for programming geometric help (scaling factor, corner rounding, etc.) using G72, G73 instructions, etc. Using the "Insert" softkey, the block corresponding to the programmed instruction is inserted after the block where the cursor is.

TEACH-IN

It is basically the same as editing in CNC language, except when it comes to programming coordinates. This option displays the coordinates of each axis and lets enter them directly into the block indicated by the cursor.

8.

8.2.2 Editing a program in the 8055 CNC language

Part-programs may be edited in the CNC's own language and in the 8055 language. The 8055 CNC programming language is enabled at the part-program editor using the "Customize" softkey of the horizontal menu. Within this option, activate the softkey of the 8055 editor. When this option is deactivated, the CNC always works with its own language.

Even when this option is active, programs may also be edited in the CNC language. The CNC assumes one or the other language depending on the name assigned to the part-program. Once a programming language has been selected, it does not admit instructions of the other language; i. e. Both languages cannot be combined in the same part-program.

Even when this option is active, it is possible to edit and execute part-programs at the CNC that have been written in the 8055 CNC language. The CNC does not allow executing instructions of the 8055 CNC from the MDI mode.

Editing a program in the 8055 CNC language

Having set the editor to accept the syntax of the 8055 CNC, the CNC assumes that this language will be used in the following cases. In the rest of the cases, the CNC interprets that the 8055 CNC language will not be used and assumes its own syntax.

- When the program name has the extension *pit* (lathe program) or *pim* (mill program). These are the native extensions of the 8055 CNC.
- When the program name is a number with no more than 6 digits (999999) like the program names at the 8055 CNC. In these cases, the CNC automatically adds the extension *pim* (for a mill) or *pit* (for a lathe).

Once the program has been opened, edit it using the 8055 CNC language; the CNC will not admit instructions of the CNC.

Program editing limitations

It is not possible to program calls to subroutines that are contained in other programs.

The syntax check is not available for programs written in 8055 CNC language. The softkey to run the syntax check of the program will be disabled.

Executing and simulating a program edited in the 8055 CNC language

To execute or simulate a program written in the 8055 CNC language (those with extensions *pim* or *pit*), the CNC converts it into its own language. The CNC always simulates and executes the converted program, which is also the one shown on the screen during the execution.

If when selecting the program, a file with extension *pit* or *pim* is selected, the CNC opens the converted file and displays it on the screen.

If any error occurs during execution, the CNC will display the block that caused it. The block will be in the language of the CNC, but it will be easily identified due to the translation format.

The conversion of the part-program

The CNC keeps both programs; the one written in 8055 format (the one edited) and its equivalent translated. The converted (translated) program is saved in the following folder with the same name but with the extension *m55* (milling program) or *t55* (lathe program).

C:\Cnc8070\Users\Prg\PRG_8055_TO_8070

The program is only converted one; the first time that is simulated or the first time that the program is selected in automatic mode.

When modifying the program edited in the 8055 CNC language, the CNC converts it again. When modifying the converted program, the CNC does not update the one written in 8055 CNC language.

8.

EDISIMU MODE (EDITING AND SIMULATION)

Program editing and simulation

FAGOR CNC 8060
CNC 8065

(REF: 1402)

If the syntax of the converted block is considerably different from the original, the CNC adds the original block as comment so as to identify it easily.

8055 language.	Converted (translated) program
G XYZ	G0 X0 Y0 Z0 (G XYZ)
T1 D2 M6	T1 D1 M06 (T1 D2 M6)
G01 G05 G90 F1000	G01 G05 G90 F1000
X10 Y23 Z33	X10 Y23 Z33
G75 X100	G100 X100 (G75 X100)
M30	M30

When the cannot translate a block because it has a function without equivalent, it will show the message "function without translation". The syntax analyzer will show this message when the index of a machine parameter is indicated parametrically.

8.

8.2.3 Program simulation

The graphic window shows the program selected at the editing window and its name appears at the bottom center of the screen.

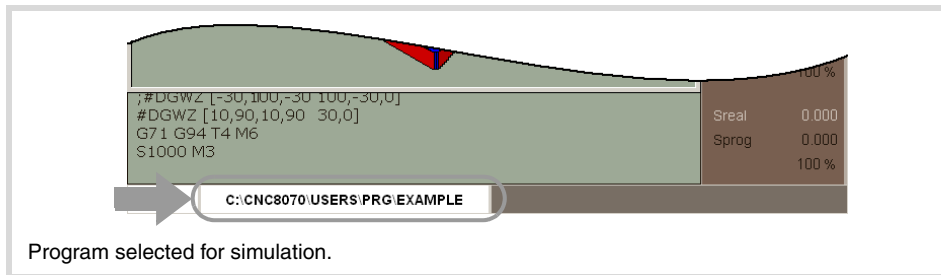

The program simulation procedure is the following:

- 1 Choose the type of graphic representation, its dimensions and the point of view. This data may also be modified during the simulation of the program.
- 2 Activate the desired simulation options using the icon menu.
- 3 Press the START icon to start the simulation. Every time the START icon is pressed, the editor saves the program being edited in the channel, even when the "save always" option is not active.
- 4 The simulation may be interrupted with the STOP icon or canceled with the RESET icon.

The simulation of the program starts at the first block of the program and ends after executing one of the end-of-program functions "M02" or "M30". As an option, it is possible to define the first and last blocks of the simulation. See "8.7 Working in the program window." on page 162.

To simulate the program, the CNC assumes the real configuration of the spindles of the channel and the configuration of the machine parameters.

"Single block" mode of simulation.

If the –single block– mode is active, program execution will be interrupted at the end of each block; the [START] icon must be pressed again to continue.



The –single block– mode is selected from the icon menu and may be selected before or while simulating the program.

Simulation options

The available simulation options are accessed from the icon menu. Pressing the icon displays a window that shows the following options.



Tool radius compensation

It activates or cancels tool radius compensation to simulate the program.

Tool radius compensation being off, the simulation will ignore the programmed tool radius compensation.



Conditional stop during simulation

It simulates the external "conditional stop" switch.

While active, the program simulation will be interrupted at the blocks having a "conditional stop" function "M01". The simulation will resume when pressing the START icon.



Software limits

It activates or deactivates the software limits for program simulation.

With the limits activated, if the software limits are reached during simulation, a simulation error message will be issued. If not active, the software limits will be ignored during simulation.

8.

EDISIMU MODE (EDITING AND SIMULATION)

Program editing and simulation

**Block jump**

It simulates the external "block skip" switch.

While active, the blocks having the block-skip character "/" will be ignored (not simulated).

**Cancel channel synchronization**

There is one icon for each channel. It cancels the channel synchronization wait periods during simulation.

When active, the wait period will end immediately and it will resume the execution of the program.

**Synchronizing spindles.**

There is an icon for each spindle where to indicate the spindle to synchronize with. The '0' value cancels the synchronization.

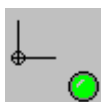
**Assume the active origins for execution.**

With this option, when starting the simulation or pressing the simulation reset, the CNC applies to the simulation the origins set in the execution environment (for example, the part zero set in jog mode).

8.2.4 Simulation errors

When an error occurs, the CNC will display a window describing the cause of the error. These errors are displayed in the middle of the screen, regardless of which window is active. Pressing the [ESC] key closes the windows one by one. Use the [↑][↓] keys to see the various windows without closing them.

There are two types of errors. The top of the window shows the category and it will have a different color depending on the type of error it shows.

WARNING

It is just a warning, it does not interrupt the simulation of the program.

The warnings programmed with the instruction #WARNINGSTOP interrupt the execution of the program where the instruction is located. In this case, It's up to the user to either resume the simulation at this point, [START], or abort the program, [RESET].

ERROR

The errors do not interrupt the simulation of the program.

Although the window displaying them may be closed by pressing [ESC], it does not mean that the error status has been taken care of; to do that, press the [RESET] icon. The program can be neither edited nor simulated while the error stays state active.

8.**EDISIMU MODE (EDITING AND SIMULATION)**

Program editing and simulation

FAGOR **CNC 8060
CNC 8065**

(REF: 1402)

8.3 Editing window

This window may be used to edit, modify or see the contents of a part-program and check the program for syntax errors.

Description of the editing window

The editing window shows the following information:

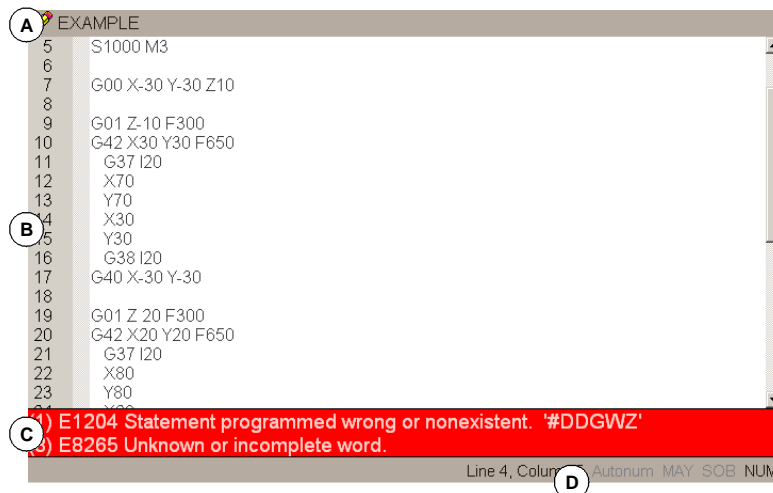

A Title bar

Name of the program selected for editing. It also indicates whether it is a read-only program or not (if read-only, while simulating or executing). An "*" next to the program means that the program has been modified since last saved (only if automatic program saving is off).

B Edit area.

Line number and area for editing the program.

C Editing errors (if any) and programming assistance. If the text is not display in full, place the focus in this area and move the text using the [←][→][↑][↓] keys.

- This area shows, on a red background, the errors that occur while editing the program or the errors found after running a syntax check of the program.
- This area shows, on a blue background, the contextual assistance offered by the editor when programming commands in high level language.

D Status bar.

Information about cursor position and the status of the editor options such as:

AUTONUM: Automatic block numbering. When active, the CNC automatically numbers the new blocks being generated.

CAP: Capital letters. When active, the text is always written in capital letters.

OVR: Overwrite text. It toggles between overwriting and inserting text. When active, it overwrites the existing text.

NUM: Numeric keypad active.

Functionalities of the editor.

Group lines at the editor.

Comments having an asterisk (*) and programmed at the beginning of the block allow to group blocks. Blocks programmed between these comments will be grouped and may be expanded or shrunk the same way as the cycles or profiles.

Expand y hide cycles, profiles and grouped blocks.

The editor offers the [ALT]+[-] hotkey to expand y hide cycles, profiles and grouped blocks. If the CNC has a mouse, click on the symbol located to the right of the cycle, profile or group of blocks to expand them and hide them.

8.

EDISIMU MODE (EDITING AND SIMULATION)
Editing window



CNC 8060
CNC 8065

(REF: 1402)

Having the "Hide cycles/profiles" option is active, the editor only shows the name of the canned cycle or of the profile. Having this option active, when the cursor moves over a hidden element, it expands automatically; when the cursor moves out of the element, it shrinks again.

Zoom at the editor.

The editor has the following hotkeys to increase or decrease the size of the editor font. If the CNC has a mouse with a wheel, the [CTRL] key combined with this wheel can also be used to increase and decrease the size of the text font.

- [CTRL][+] Zoom in.
- [CTRL][-] Zoom out.

Multi-line blocks.

```
POCK.)
L
.C.M=0
```

The editor adjusts the long blocks to the size of the window dividing the block into several lines. On the right side of each cut line, the editor shows a symbol to indicate that the block continues in the next line.



CNC 8060
CNC 8065

(REF: 1402)

8.3.1 Softkey and hotkey menus.

Horizontal softkey menu.

The options available in the softkey menu are the following.

Softkey.	Description.
Open program.	Open a program at the editor.
Operations with blocks.	Copy, cut and paste text and blocks as well as copy a block or set of blocks as an independent program. Also find a line or a text in the program and replace a text with another one.
Undo and redo.	Undo the last modifications made.
Geometry and planes.	Access the help for programming inclined planes and geometric help.
Cycle editor.	Access the editor for machining and probing canned cycles.
Profile editor.	Access the profile editor and define a new profile or modify an existing one.
File.	Recall, save, save with another name or print a program. It can also be used to import the contents of another program, of a DXF file or PIM and PIT files.
TEACH-IN.	Turn TEACH-IN mode on or off.
Customizing.	Customize the appearance and the properties of the editing window.

Hotkeys of the editor.

Shortcut	Function.
[CTRL]+[C]	Copy the selected text.
[CTRL]+[X]	Cut the selected text.
[CTRL]+[V]	Paste the selected text.
[CTRL]+[Z]	Undo the last change.
[CTRL]+[Y]	Redo the selected text.
[CTRL]+[G]	Save the program/Recover the original program.
[CTRL]+[+]	Zoom in.
[CTRL]+[-]	Zoom out.
[ALT]+[-]	Hide or expand a cycle.
[CTRL]+[HOME]	Move the cursor to the beginning of the program.
[CTRL]+[END]	Move the program to the end of the program.
[CTRL]+[TAB]	Toggle between the editor and the error window.

8.

8.3.2 Contextual programming assistance.

The contextual assistance is shown when editing commands in high level language.

- Keying in "V" shows the list of CNC variables.
- Keying in "#" shows the list of CNC instructions.
- Keying in "\$" shows the list of flow control instructions of the CNC.

In all of them, when keying the following letter of the variable or instruction name, the cursor of the list goes to the first command that starts with that letter. The [↑][↓] keys may be used to move the cursor through the list of commands and the [ENTER] key to enter the selected command into the block that is being edited.

Entering a help element in the block being edited.

When an element has been selected from the list and [ENTER] is pressed, the editor inserts in the cursor position the element selected in the drop menu.

- If the statement does not have parameters, the editor inserts the whole statement.
- If the statement has parameters, but the text written by the user does not have any parameters, the editor inserts only the fixed part of the statement. If the user has written a parameter, the editor does not insert anything.
- If it is not an axis variable and/or array variable, the editor inserts the whole variable.
- If it is an axis variable and/or array variable, but the user has not written it, the editor inserts only the fixed part of the variable. If it is an axis variable and/or array variable and the user has written it, the editor does not insert anything.

After inserting an element, if it is necessary, the bottom of the screen maintains the contextual assistance for that element to complete the editing of the block. Pressing [ENTER] again, the contextual assistance disappears from the bottom of the screen.

Activating the contextual assistance.

Contextual help is activated from the general customizing options. Contextual assistance is not available when using the 8055 CNC language.

8.

EDISIMU MODE (EDITING AND SIMULATION)
Editing windowFAGOR CNC 8060
CNC 8065

(REF: 1402)

8.3.3 Help for programming subroutines.

Subroutine help files.

Help files may be associated with each OEM subroutine (G180/G189 and G380/G399) and each global subroutine called upon using #MCALL or #PCALL and they will be displayed while editing. Each subroutine may have two help files; a text file (txt) and an image file (bmp).

The help window is displayed while editing, after a blank space or tab following a G function or following the name of the subroutine. The help window is only informative, it cannot be accessed with the cursor nor browse through it. When the help file is displayed, its text may be inserted into the part-program using the [INS] key. The help window closes with [ESC], deleting the key word or going on to another line of the program.

The help window of the subroutines is only available when the editor uses the CNC language; when the editor is enabled for the 8055 CNC, these helps are not available. The help window of the subroutines is available even when the contextual helps of the editor are disabled.

List of available subroutines.

The editor allows having in a text file (txt) a list that is displayed while editing the part-program, every time a #PCALL or an #MCALL instruction is edited.

The editor shows the list of subroutines while editing, after a blank space or tab following a G180-G189 or following a #PCALL or #MCALL instruction. This list works the same way as the lists of variables, it is possible to use the arrow keys to scroll through the various elements. Pressing [ENTER], the editor inserts the selected line in the current position of the cursor. The list of subroutines disappears with [ESC], deleting the key word or going on to another line of the program.

The help is always active, even when the contextual helps of the editor are disabled.



For further information on how to define the help on subroutines, refer to the programming manual.

8.

EDISIMU MODE (EDITING AND SIMULATION)

Editing window

8.3.4 Syntax errors when editing

The syntax errors occurred while editing or after running a syntax check will be displayed at the bottom of editing window. To toggle the cursor between the editor and the error listing, press the key combination [CTRL]+[TAB].

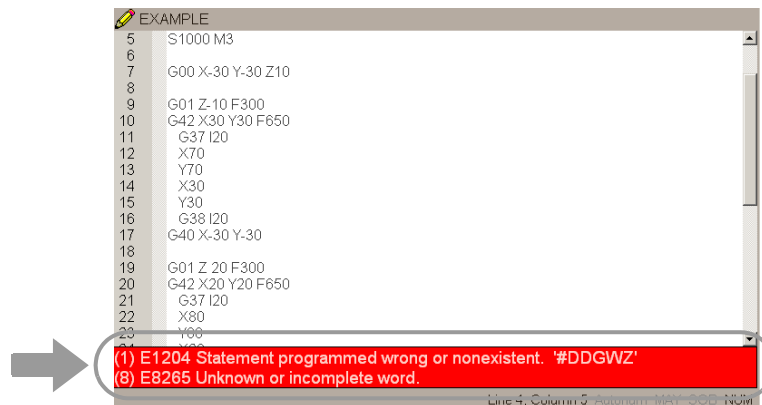

Errors while editing

While editing, each block is analyzed when entered. If a syntax error is detected in the block, the error window will display the following information:

- Position of the error in the block.
- Error number and explanatory text.

Errors after a syntax check



The syntax check is executed from the icon menu. The syntax check is not available for programs written in 8055 CNC language.

The syntax check checks all the blocks of the program. If a syntax error is detected, the error window will show the following information.

- Location and name of the program being checked.
- Line number and position of the error within the block.
- Explanation of the error.

Moving the cursor through the errors of the window, the editor will highlight the block containing the selected error. Use the [↑][↓] keys to move the cursor. Press [ENTER] to select the block containing the error or press [ESC] to close the error window.

If the text is not display in full, place the focus in this area and move the text using the [←][→][↑][↓] keys.

8.

EDISIMU MODE (EDITING AND SIMULATION)
Editing window

FAGOR 

CNC 8060
CNC 8065

(REF: 1402)

8.4 Working in the editing window.

8.4.1 Select a program.

The "Open program" softkey is used to select a program in EDISIMU mode and may be a new program or an existing one. A different program may be edited and executed in each channel. When selecting this option, the CNC shows a list of the available programs. See "[3.7 File selection window](#)" on page 63.

To select a program from the list:

- 1 Select the folder that contains the program. If it is a new program, it will be saved in this folder.
- 2 Select the program from the list or write its name in the bottom window. To edit a new program, write the name of the program in the lower window and the CNC will open an empty program or a predefined template depending on how the editor is configured. See "[8.4.6 Customizing the editor.](#)" on page 153.
- 3 Press [ENTER] to accept the selection and open the program or [ESC] to cancel it and close the program listing.

8.4.2 Operations with blocks. Cut and paste.

The "Operations with blocks" softkey is used to copy, cut and paste the information of a block or set of blocks and export this information as an independent program. This option is only available when there is a text selected in the program or on the clipboard. To select a text in the program, keep the [SHIFT] key pressed while moving the cursor.

Operations with blocks "Copy"

Copy the selected text onto the clipboard.

Operations with blocks "Cut"

Copy the selected text onto the clipboard and deletes it from the program.

Operations with blocks "Paste"

Paste the contents of the clipboard into the program.

Operations with blocks "Copy to program"

Save the selected texts as an independent program. When selecting this option, the CNC shows a list of the available programs. To save the text as a program:

- 1 Select the destination folder.
- 2 Define the file name at the bottom window. To replace an existing file, select it from the list.
- 3 Press [ENTER] to save the program or [ESC] to cancel the selection and close the program listing.

8.

8.4.3 Find a line or a text in the program.

The "Operations with blocks" softkey is used to find a line or a text in the program and replace a text with another one. When selecting this option, the CNC shows a dialog box requesting the line number or the text to look for. When defining a text search, certain options may also be defining that allow:

- A Go to a line of the program.
- B Replacing the text being searched with another in the program.
- C Ignore uppercase and lowercase.
- D Consider the text to find as a whole word.
- E Select whether the search starts at the beginning of the program or at the cursor position.
- F Direction of the search.

After defining the search options, press [ENTER] to start the search or [ESC] to cancel it. The text found in the program will be highlighted and the softkey menu will show the following options:

- "Replace" option, to replace the highlighted text.
- "Replace all" option, to replace the text throughout the whole program.
- "Find next" option, to skip this text and keep on searching.
- "Find previous" option, to look for the text without replacing it.

To end the search, press [ESC].

8.4.4 Undo and redo.

This softkey may be used to "undo" the last modifications made. The modifications are undone one by one starting from the most recent one. The CNC offers the following keyboard shortcuts to undo and redo the operations.

- | | |
|------------|-------------------------|
| [CTRL]+[Z] | Undo the last change. |
| [CTRL]+[Y] | Redo the selected text. |



EDISIMU MODE (EDITING AND SIMULATION)
Working in the editing window.

8.4.5 Operations with files.

The "File" softkey is used to recall, save or print the program as well as import dxf, pit or pim files.

File "Restore original"

This softkey is used to recover the original file without the changes made since the last time it was opened. When selecting this option, the CNC requests confirmation of the command. In programs larger than 2MB, the editor does not offer the option to recover the original program.

This option is only available when the "auto save" option is active. See ["8.4.6 Customizing the editor."](#) on page 153.

File "Save"

This softkey saves the file that is being edited.

This option is only available when the "auto save" option is not active. See ["8.4.6 Customizing the editor."](#) on page 153.

File "Save as"

This softkey saves the file, that is being edited, with a different name. After saving the file, one keeps editing the new file. Once the program has been saved, the top of the editing window will show the name of the new program.

When selecting this option, the CNC shows a list with all the programs already saved. To save a program with another name:

- 1 Select the destination folder.
- 2 Write the program name in the bottom window. To replace an existing program, select it from the list
- 3 Press [ENTER] to save the program or [ESC] to return to the editor without saving the program.

File "Include program"

This softkey may be used to import the content of a part-program into the one being edited. Any program that may be accessed from the CNC may be imported, even the program currently in execution. The selected program is added to the one being edited after the block indicated by the cursor.

When selecting this option, the CNC shows a list of the programs that may be imported into the one being edited. To import a program from the list:

- 1 Select the desired program from the list or write its name in the bottom window.
- 2 Press [ENTER] to import the program or [ESC] to cancel the selection and close the program listing.

File "Print"

This softkey may be used to print the program in the pre-determined printer.

File "Import"

This softkey is used to import DXF, PIM and PIT files into the program being edited.

- The DXF format is standard for exchanging graphic files. Importing this type of files makes it possible to generate the part-program directly from a drawing. The files must consist of points, lines and arcs. See ["8.4.8 Import DXF files"](#) on page 156.
- PIM and PIT files are part-programs used by the 8055 CNC. When importing this type of file, its programming language is adapted to the one used by the CNC.

When selecting this option, the CNC shows a list of the programs that may be imported into the one being edited. Select the desired program from the list and press [ENTER].

8.

EDISIMU MODE (EDITING AND SIMULATION)
Working in the editing window.



CNC 8060
CNC 8065

(REF: 1402)

8.4.6 Customizing the editor.

The "Customize" softkey is used for personalizing (customizing) the behavior, properties and appearance of the program editor.

Customizing the general options of the editor.

Option.	Meaning.
Save always.	Activating the automatic saving of the program. When this option is active, the CNC will automatically save the program every time the cursor changes blocks. In large programs (more than 200 kB), the CNC saves the program when the user has not modified the program for about 5 seconds. If this option is not active, the program is saved from the softkey menu.
Line adjust.	Adjust the long blocks to the size of the window dividing the block into several lines. In large programs (more than 200 kB), the CNC does not adjust the lines.
Show the line number.	Show the line numbers at the editor.
Drop menus.	Organize the horizontal softkey menu in drop menus.
Hide cycles and profiles.	Hide the contents of the canned cycles and of the profiles. Being this option active, the editor only shows the name of the canned cycle or profile; otherwise, it shows the whole contents. In large programs (more than 200 kB), the editor does not hide the canned cycles or the profiles. Having this option active, when the cursor moves over a hidden element, it expands automatically; when the cursor moves out of the element, it shrinks again.
Editor 8055.	Activate editing in 8055 CNC language. See "8.2.2 Editing a program in the 8055 CNC language" on page 139.
Programming assistance.	Activate the contextual assistance for programming commands in high level language. Contextual assistance is not available when using the 8055 CNC language. See "8.3.2 Contextual programming assistance." on page 147.

Customize the template for new programs.

This option activates the use of the template for new programs. The "Edit template" button opens a template at the editor to edit it. Only one template may be in the editor, called "Template.nc" and must be saved in the following folder.

C:\Cnc8070\Users\Session\Templates

The "Save always" option of the editor sets how the template is saved, automatically or from the softkey menu.

Set the parameters for editing in TEACH-IN.

This option sets the behavior of each axis in TEACH-IN mode. Each axis may have one of the following behaviors. After defining the behavior of the axes, press [ENTER] to accept the selection or [ESC] to reject it.

Behavior.	Meaning.
Selected and visible.	The axis is displayed in the TEACH-IN window and it is included in the blocks being edited by pressing the [RECALL] key.
Not selected and visible.	The axis is displayed in the TEACH-IN window, but it is not included in the blocks being edited by pressing the [RECALL] key.
Not selected and hidden.	The axis is neither displayed in the TEACH-IN window nor included in the blocks being edited by pressing the [RECALL] key.

Set the auto-numbering of new blocks.

This option activates the auto-numbering of blocks and may be used to set the number of the first block and the sequencing step for two consecutive blocks. While auto-numbering is active, the CNC inserts the block number automatically every time a new block is generated.



EDISIMU MODE (EDITING AND SIMULATION)
Working in the editing window.



CNC 8060
CNC 8065

(REF: 1402)

Customize the appearance of the editor.

This option customizes the appearance (color, font, etc.) of the elements that make up the program editor. After defining the new look, press [ENTER] to accept the changes or [ESC] to ignore them.

Customize the syntax coloring.

This option may be used to customize the color of the elements (functions, comments, etc.) that make up the program. After defining the new look, press [ENTER] to accept the changes or [ESC] to ignore them. In large programs (more than 200 kB), the editor cancels the syntax coloring.

8.**EDISIMU MODE (EDITING AND SIMULATION)**

Working in the editing window.



CNC 8060
CNC 8065

(REF: 1402)

8.4.7 TEACH-IN

The "Teach-in" softkey is used to activate or deactivate the TEACH-IN mode; in this mode, the axes may be moved manually and their position may be assigned to a block. When this mode is active, the top of the editing window shows the position of the axes defined as "visible" for the TEACH-IN mode. See ["8.4.6 Customizing the editor."](#) on page 153.

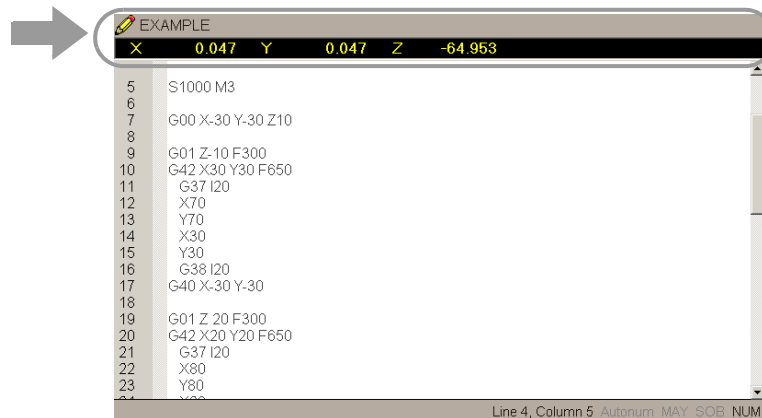

When TEACH-IN mode is active, it is possible to keep editing the coordinates of the axes directly from the keyboard or they may be assigned the current position of the machine axes. Both editing methods may be used indistinctly, even while defining a block. To define the coordinates of one or several axes using TEACH-IN:

- 1 Move the axes to the desired position using the JOG keys, the handwheels or the MDI mode.
- 2 In the part-program, edit the name of the axes whose position is to be defined or not select any axis if you wish to define the position of all of them.
- 3 Press the [RECALL] key.

If an axis of the channel has been edited, the CNC assigns the current position of that axis as the program coordinate. The axis is displayed in the TEACH-IN window.

If only the block number or an empty line has been edited, it inserts a block with the position of all the axes of the channel defined as "selected" for the TEACH-IN mode.

If a character has been edited other than the axis name or the block number, it does not insert anything and the cursor stays in the same place.

8.

EDISIMU MODE (EDITING AND SIMULATION)

Working in the editing window.

FAGOR 
CNC 8060
CNC 8065

(REF: 1402)

8.4.8 Import DXF files

The DXF format is standard for exchanging graphic files. Importing this type of files makes it possible to generate the part-program directly from a drawing. The DXF file may consist of points, lines and arcs. It can also consist of polylines, but they must be previously uncombined.

The program editor and the profile editor can import DXF files. When selecting this option, the editor shows a list of the programs that may be imported. Select the desired program from the list and press [ENTER].

After selecting the file, define how the various layers of the DXF file are to be converted into ISO code. Once this data has been set, press the "Convert" softkey to import the file into the part-program.

DXF file configuration

When importing a DXF file, it shows the configuration window to define how the different layers of the drawing must be treated. The configuration window shows three areas clearly and distinctly.

Layer description area

The DXF files may consist of layers and each one has different heights of the drawing. All the layers together make up the whole drawing.

When importing the file, you can decide which layers to include in the part-program. By default, all the layers are included. To exclude a layer, select it and press the "Disable layer" softkey.

For each layer, it indicates its priority and offset (height) on the perpendicular axis.

Layer priority and offset

It shows the data of the layer selected by the cursor. For each layer, one must define its priority and offset (height) on the perpendicular axis.

- The priority defines the order in which the layers will be executed; i.e. the order in which they will be included in the part-program. Those with priority ·1· will be executed first and so on.
- The offset (height) on the perpendicular axis permits executing each layer in the desired Z coordinate (or that of the relevant perpendicular axis).

Work plane

The work plane must be defined before importing the file in the part-program. The plane is defined by selecting the abscissa axis, the ordinate axis and the perpendicular axis.

When importing it in the profile editor, the plane will be the one selected at the editor and only the perpendicular axis can be selected.

8.

EDISIMU MODE (EDITING AND SIMULATION)
Working in the editing window.



CNC 8060
CNC 8065

(REF: 1402)

8.4.9 Profile editor.

The profile editor may be accessed from the softkey menu to edit a new one, or selecting a profile of the program and pressing the [RECALL] key. The profile editor shows its options on the softkey menu. See chapter "9 Profile editor".

To return to editing the program, press "End". The softkey menu of the program editor shows the "insert profile" softkey to insert the defined profile into the program. The block for the defined profile is inserted after the block where the cursor is.

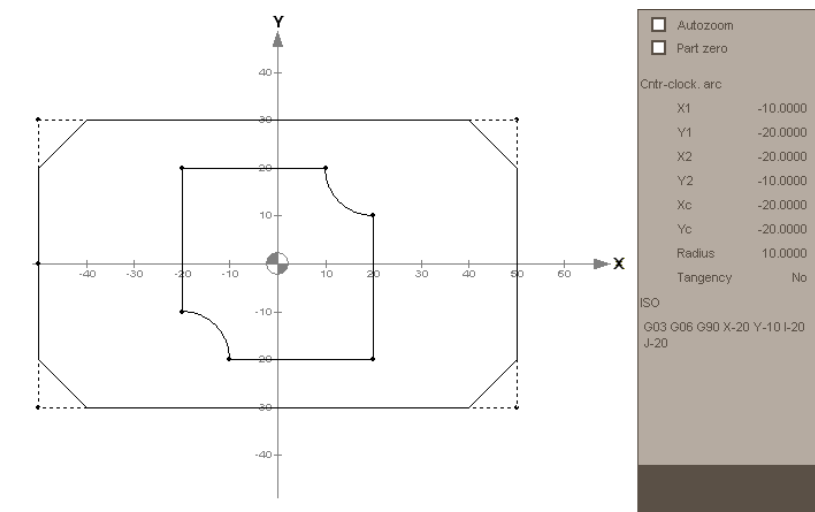

EDISIMU MODE (EDITING AND SIMULATION)

Working in the editing window.

8.4.10 Canned cycle editor.

The cycle editor may be accessed from the softkey menu to edit a new one, or selecting a cycle of the program and pressing the [RECALL] key. The softkey menu of the cycle editor shows the available canned cycles.



To return to the program editor, press the [BACK] key. The softkey menu of the program editor shows the "insert cycle" softkey to insert the defined cycle into the program. The block for the defined cycle is inserted after the block where the cursor is.



Canned cycles have a specific manual both for milling and turning. Refer to the documentation included in the CD-Rom that comes with the product for further detail.



CNC 8060
CNC 8065

(REF: 1402)

8.4.11 Inclined planes (-M- model)

The inclined-plane editor may be accessed from the softkey menu to edit a new one, or selecting an inclined plane of the program and pressing the [RECALL] key.



The softkey menu of the inclined-plane editor shows the various ways to program inclined planes. To return to the main menu, press the [BACK] key.

Inclined planes programmed directly in ISO code using the instructions #CS and #ACS can also be restored using the [RECALL] key. This way, it is possible to check the programmed parameters and the resulting inclined plane.

Once the inclined plane has been defined, press [ESC] to quit the editor. The softkey menu will show the "insert inclined plane" softkey to insert the defined inclined plane into the program. The block for the defined inclined plane is inserted after the block where the cursor is.



For further information on how to program inclined planes, instructions #CS and #ACS, refer to the programming manual.

8.

EDISIMU MODE (EDITING AND SIMULATION)
Working in the editing window.

Description of the help screen for inclined planes.

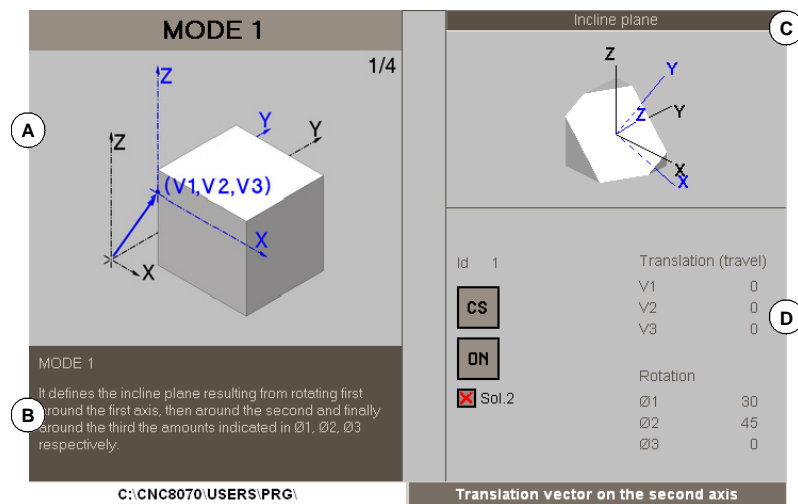

- A Help graphics. Sequence of drawings showing each step for defining the inclined plane. When the focus is on a programmable parameter, the sequence will stop and show the relevant explanatory drawing.
- B Short explanation on how to program the selected inclined plane.
- C Drawing of the resulting inclined plane. The drawing is updated (refreshed) as the user programs the different parameters that affect the geometry of the inclined plane. The drawing shows the following elements.
- The inclined plane in white.
 - The reference system of the inclined plane, X' Y' Z', in blue.
 - When there is a translation vector (V1, V2, V3), the drawing will show a reference system at the lower left side of the drawing. The distance between this reference system and the cube is not proportional; the graphics is merely approximate.
- When the drawing is selected with the focus, the cube may be rotated using the [←][→][↑][↓] keys or using the wheel of the mouse.
- D Parameters to define the inclined plane.



CNC 8060
CNC 8065

(REF: 1402)

8.4.12 Geometric-help editor (.M- model)

The geometric-help editor may be accessed from the softkey menu to edit a new one, or selecting one of the program helps of the program and pressing the [RECALL] key. Geometric helps programmed directly in ISO code can also be recalled by pressing the [RECALL] key to check the programmed parameters.







The softkey menu of the geometric-help editor shows the various programmable helps. To return to the main menu, press the [BACK] key.

Once the help has been defined, press [ESC] to quit the editor. The softkey menu will show the "insert geometric help" softkey to insert the help into the program. The block for the defined geometric help is inserted after the block where the cursor is.

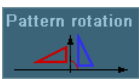

For further information on how to program geometric help, refer to the programming manual.

Horizontal softkey menu.

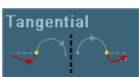
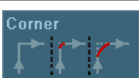
Softkey.	Meaning.
	Scaling factor.
	Mirror image.
	Rotate the coordinate system.
	Corner chamfering and rounding.
	Tangential entry and exit.
	Square, semi-rounded or rounded corner.

Description of the screen of the geometric-help editor.

- A Help graphics.
- B Short explanation on how to program the geometric help.
- C Parameters to define the inclined plane.

8.5 Graphics window

This window is used to show a graphic representation of the program being simulated and take measurements over the drawing. The CNC has different types of graphics.

8.

EDISIMU MODE (EDITING AND SIMULATION)

Graphics window

Part Zero	
X	-30.000
Y	-30.000
Z	10.000
M41	
G1 G17	
Tool	4 D 1
Freal	0.000
Fprog	0.000
	100 %
Sreal	0.000
Sprog	0.000
	100 %

```

;#DGWZ [-30,100,-30 100,-30,0]
#DGWZ [10,90,10,90 30,0]
G71 G94 T4 M6
S1000 M3
    
```

1 | C:\CNC8070\USERS\PRG\EXAMPLE



CNC 8060
CNC 8065

(REF: 1402)

8.6 Program window

This window shows the contents of the program selected for simulation and allows selecting the first and last blocks of the simulation. When not selected, the simulation will begin at the first block of the block and will end after executing one of the end-of-program functions "M02" or "M30". While simulating, the window cursor will show the block being simulated.

Description of the program window

The program window shows the following information:

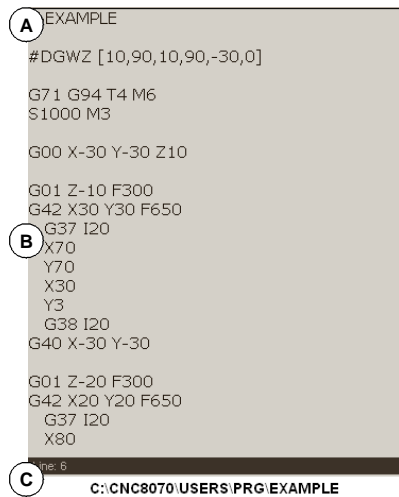

A Title bar.

Name of the program selected for simulation.

B Program blocks selected for simulation.

While simulating, the cursor will indicate the block being simulated. The "active subroutines" option being active, the window displays information related to the execution of subroutines, canned cycles, repetition blocks and loops.

C Program line.

Line of the program where the cursor is.

Horizontal softkey menu.

When selecting the program window, the horizontal softkey menu will show the options related to this window.

Softkey.	Description.
Block selection.	Select the first and last blocks of the execution.
Display.	Toggle between the various screens of the EDISIMU mode and display information related to the status of the subroutines, canned cycles, repetition blocks and loops.
Exblk.	Execute only the block selected with the cursor.
Graphics.	Show the graphics screen.



CNC 8060
CNC 8065

(REF: 1402)

8.7 Working in the program window.

8.7.1 Select the first and last blocks of the execution.



After selecting the "block selection" softkey, the horizontal softkey menu shows the following options. To return to the main menu, press the [BACK] key.

Softkey.	Description.
Set beginning	First block for execution or for manual block search.
Stop condition.	Set the condition to end the execution or the manual block search.
Find text.	Find text

Set beginning.

This option sets as starting block for simulation the block selected with the cursor. When not setting the first block, the simulation will begin at the first block of the program.

The first block may be selected using the cursor or the "Find text" option of the softkey menu. The selected block stays active until canceled (selecting another block or selecting the same one again) or simulating the program.

Stop condition.

This option sets the block where the simulation of the program or subroutine will be interrupted. After executing that block, the execution may be resumed with the [START] icon or canceled with the [RESET] icon. If no last block is established, the simulation of the program will end after executing one of the end-of-program functions "M02" or "M30".

Select subroutine.

This option selects the stop condition in a global subroutine which has been called upon from the program. When selecting this option, the CNC shows a list of the available subroutines. After selecting the desired subroutine, it will appear in the program window.

Set stop block.

This option sets as simulation interruption block the block selected with the cursor. If no last block is established, the simulation of the program will end after executing one of the end-of-program functions "M02" or "M30".

The last block may be selected using the cursor or the "Find text" option of the softkey menu. The selected block stays active until canceled (selecting another block or selecting the same one again) or executing the program.

Number of times.

This option sets as stop condition, that the block selected as the last block has been executed a specific number of times.

When selecting this option, the CNC requests the number of times that the block must be executed before ending the execution of the program. After entering the number of times, press [ENTER] to validate the value or [ESC] to cancel it.

Find text.

This option shows a dialog box for placing the cursor on a particular line of the program or search for text or a character string in the program.

Go to line.

In this area of the dialog box, the CNC requests the line number to go to. Key in the desired number and press [ENTER], the cursor will then go to that line.

8.

Find text

In this area of the dialog box, the CNC requests the text to look for. It is also possible to select whether the search must start at the beginning of the program or at cursor position.

To start the search, press [ENTER] and the cursor will position on the text found. Pressing [ENTER] again, the CNC will look for the next match and so on. To end the search, press [ESC]. The cursor will position on the block containing the text searched.

8.

EDISIMU MODE (EDITING AND SIMULATION)

Working in the program window.

FAGOR 

**CNC 8060
CNC 8065**

(REF: 1402)

8.7.2 Simulate program blocks separately.

From the EDISIMU mode, it is possible to simulate blocks of a program separately; i.e. it is possible to select a block of the program and simulate only that block. Blocks executed like this change the history of the M and G functions.

Press the "EXBLK" softkey of the horizontal menu to enable this function. Being this option active, every time the START icon key is pressed, it only simulates the block selected in the active program. Once that block is simulated, another block may be simulated by selecting it with the cursor and pressing [START] again and so on. The blocks may be selected with the [↑] [↓] keys.

8.

EDISIMU MODE (EDITING AND SIMULATION)

Working in the program window.



CNC 8060
CNC 8065

(REF: 1402)

8.7.3 Display the status of the program or of the active subroutines.

From the horizontal softkey menu, it is possible to toggle between the display of program blocks and the display of information related to the status of the subroutines, canned cycles, repetition blocks and loops.

Having this option active and the program execution interrupted, the user can use the cursor to select an information line and press [ENTER] to skip to the corresponding program block.

Description of the information displayed.

The information is laid out in a table with four columns and having the following meaning.

Column.	Meaning.
S	Nesting level of the subroutine.
P	Nesting level of the local parameters used in the subroutine.
Sub	Name of the program, subroutine or canned cycle.
Op	Type of block being simulated. The loops are shown with a progress bar and a text indicating the loop it is in.

The window shows the following information.

Type of block.	Information displayed.
L	Name of the subroutine
LL	Name of the subroutine
#CALL	Name of the subroutine
#PCALL	Name of the subroutine
#MCALL	Name of the subroutine
G180 through G189	Name of subroutine associated with the G function.
M function.	Name of the subroutine associated with the M function.
T function.	Name of the subroutine associated with the T function.
Canned cycle.	G function associated with the canned cycle.
#EXEC	Name of the subroutine
#EXBLK	
\$RPT	Number of current loop and total number of loops.
\$FOR	Number of current loop and total number of loops.
\$WHILE	Number of current loop.
\$DO	Number of current loop.
\$IF	Text "IF".
\$SWITCH	Text "SWITCH".



EDISIMU MODE (EDITING AND SIMULATION)
 Working in the program window.



CNC 8060
CNC 8065

(REF: 1402)

8.8 Statistics window

This window offers an estimate the total program execution time at 100% of the programmed feedrate and the machining time for each tool. For this execution time estimate, the CNC analyzes the following.

- The machining and positioning time for each tool used in the program.
- The number of "M" functions that are executed.
- The number of tool changes performed.

Description of the statistics window

This statistics window shows the following information:

Positioning and machining in seconds		
TOOL	Positioning	Machining
0	0.000	0.000
1	1.567	18.572
2	0.600	54.015
3	0.840	97.677

A General information.

It shows a time estimate of program execution at 100% of the programmed feedrate, the number of "M" functions executed and the number of tool changes made.

B Machining time for each tool.

It shows a list of the tools used in the program indicating the machining time for each tool and the total positioning time.

C "G" functions active during simulation.



EDISIMU MODE (EDITING AND SIMULATION) Statistics window



CNC 8060
CNC 8065

(REF: 1402)

8.8.1 Time estimates

The statistics window shows an estimate of the execution of the program selected in the editing window, and whose name appears at the bottom center of the screen.

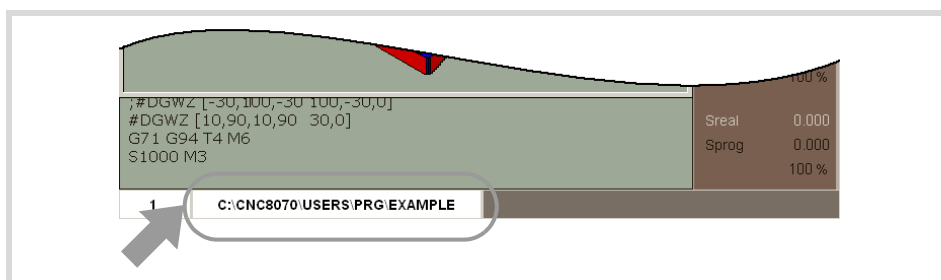

The process to estimate time is the following:

- 1 Use the program window to select the first and last block for the execution time estimate. If not selected, the execution time estimate will be done from the first block of the program to the execution of one of the end-of-program functions "M02" or "M30".
- 2 Select the desired simulation options.
- 3 From the vertical softkey menu, start calculating the execution time estimate.



8.

EDISIMU MODE (EDITING AND SIMULATION)
Statistics window

FAGOR 

CNC 8060
CNC 8065

(REF: 1402)

8.

EDISIMU MODE (EDITING AND SIMULATION)

Statistics window



CNC 8060
CNC 8065

(REF: 1402)

9.1 Interface description.

The profile editor is used to edit quickly and easily simple rectangular, circular profiles and any type of profile consisting of straight and curved sections. As the profile data is entered, the editor shows a graphic representation of the profile.

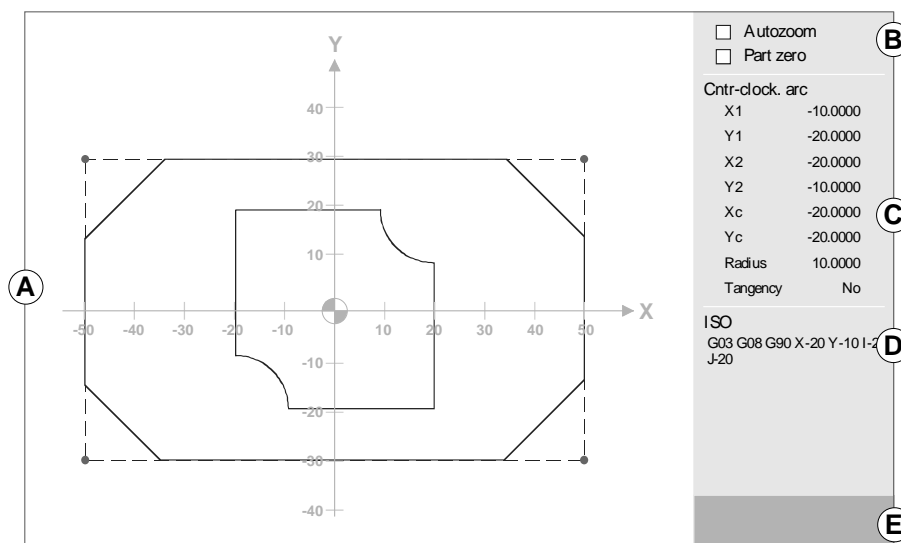

- A** Graphic area. Graphic representation of the profile being drawn, axes coordinated with autoscale and name of the axes that make up the plane. The name of the axis indicates the positive direction of the axis.
- B** Status of the autozoom and part zero options, regarding the display of the profile at the editor.
- C** Data entry area.
- D** Translation (conversion) of the selected profile or part of it into ISO code
- E** Area used to enter the values of the corners or the ISO coded text to be added to the element.

Keyboard shortcuts.

These options will not be available when a menu for editing data or selecting items is active at the editor.

Keys.	Meaning.
[←] [→] [↑] [↓]	Move the graphics.
[+] [-]	Enlarge or reduce the display area.
[=]	Apply optimum zoom.
[/]	Keeps the part zero visible at all times.
[*]	Activate autozoom.

Softkey menu.

The options that may be selected from the softkey menu make it possible to edit profiles, modify edited profiles, select the zoom, the work plane, undo the last change and end the editing session. While editing or modifying the profile, the softkey menu offers the option to undo the last operation. Likewise, it offers the option to save the profile at any time.

Softkey.	Meaning.
Edit	Edit a new profile, enlarge an existing profile or import a profile saved in DXF format. See "9.2 Define a new profile, enlarge an existing one or import one from a file." on page 172.
Modify	Modify, insert or delete elements of a profile. See "9.3 Modify a profile and insert corners" on page 179.
Displayed area	Modify the zoom of the graphics area. See "9.4 Configuring the profile editor. Displayed area." on page 181.
Plane	Define the work plane. See "9.5 Configuring the profile editor. Define the work plane." on page 181.
End	End the profile editing session and insert the edited profiles into the program. See "9.6 End the session at the editor." on page 181.
Undo	Undo the last operation.
Save and continue	Save the profile and continue editing. Using this key does not require that the profile be completed.

9.

PROFILE EDITOR

Interface description.



CNC 8060
CNC 8065

(REF: 1402)

9.1.1 How to use the profile editor.

Several profiles may be edited without having to exit the profile editor. To edit a profile, proceed as follows:

- 1 Define the work plane at the profile editor.
- 2 Select the type of profile to be edited, such as a circular or rectangular profile or any profile.
- 3 For a rectangular or circular profile, define its data and insert it. For any profile, first select the starting point of the profile. Once the first point has been selected, draw the profile, which will be made up of straight and curved sections. If it has corner rounding, chamfering or tangential entries and exits, use one of these methods:
 - Treat them as individual sections when having enough information to define them.
 - Ignore them while defining the profile and, once it has been defined, select the corners that have those characteristics and insert them.
- 4 End the profile editing session by inserting them into the program. The portion of ISO-code program corresponding to the edited profile will be identified with the line "#PROFILE" or it will appear framed between the lines "#PROFILE BEGIN" and "#PROFILE END".

Data editing

All data need not be defined; but it is recommended to define all the known data. To define the profile data, proceed as follows:

- 1 Press the softkey corresponding to the data to be defined.
- 2 Key in the desired value (which may be a numeric constant or an expression entered via the calculator). Use the [SPACE] key to change the value of a non-numerical data (tangency, direction, etc.). Press [CTRL]+[K] to access the calculator.
- 3 Press [ENTER] to accept the defined value or [ESC] to reject it and return to the previous one. If the entered value is accepted, the CNC will select the next data.
- 4 Once all the data has been defined, press the "Validate" softkey and the CNC will show the profile that has been defined.

Displaying incomplete sections

If there isn't enough data to show the defined section, the CNC will draw as much of it as it knows. The sections that are not fully defined will be shown with a dash line.

If there are more than one possibility, use the arrow keys to view the available options one by one except the ones that could generate tangency errors later on. To select the desired option, press [ENTER]. The sections with several possibilities will be shown in green whereas the rest of the sections will be shown in white.

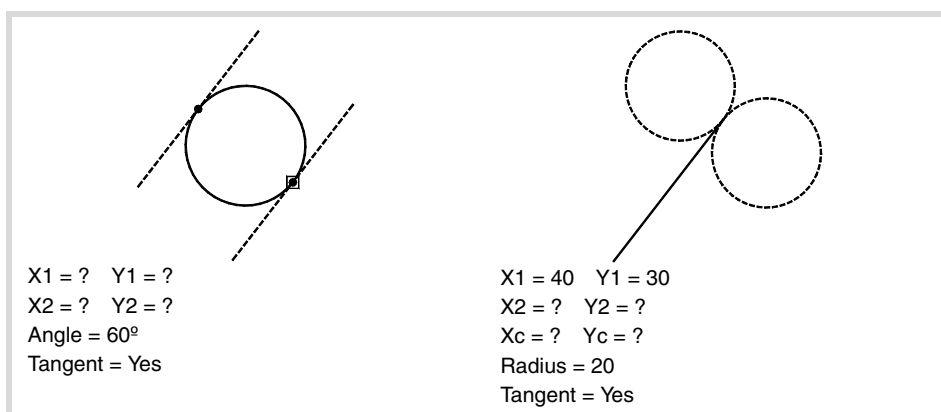

9.

PROFILE EDITOR
Interface description.

FAGOR 

CNC 8060
CNC 8065

(REF: 1402)

9.2 Define a new profile, enlarge an existing one or import one from a file.

With the softkey menu of this screen, it is possible to define any profile, a circular or a rectangular one. It can also be used to enlarge a profile already defined or import a profile saved in DXF format.

Softkey.	Meaning.
Profile	Softkey for editing any profile by defining the straight and curved sections that make it up. See "9.2.1 Define any profile using straight and curved sections." on page 173.
Circle	Softkey for quickly defining a circular profile. See "9.2.2 Define a circular profile." on page 175.
Rectangle	Softkey for quickly defining a rectangular profile. See "9.2.3 Define a rectangular profile." on page 176.
Expand a profile	Softkey for adding straight and curved sections to the profile. See "9.2.4 Enlarge a profile." on page 176.
Import profile	Softkey for importing a profile in DXF format. See "9.2.5 Import a profile from a DXF file." on page 177.

9.

PROFILE EDITOR

Define a new profile, enlarge an existing one or import one from a file.



CNC 8060
CNC 8065

(REF: 1402)

9.2.1 Define any profile using straight and curved sections.

For any element of the profile, the softkey menu may be used to define the data in Cartesian or Polar coordinates as well as in absolute or incremental coordinates. The softkeys for these options are only available when allowed by the selected data.

Softkey.	Meaning.
Cartesian Polar	Softkey to select either Cartesian or Polar coordinates.
ABS INC	Softkey to select either absolute or incremental coordinates. Being the incremental coordinates active, the editor will show the symbol Δ next to the affected data.
Polar origin	Softkey to define the Polar origin.
Direction	Direction of the profile; clockwise or counterclockwise.
Validate	Validate the profile defined.

Define the starting point of the profile.



When selecting a new profile, the starting point must always be defined first. Once the profile's starting point has been defined, the softkey menu will show the necessary options to define the profile. To return to the main menu, press the [BACK] key.

The starting point may be edited both in Cartesian and Polar coordinates, but always in absolute coordinates.

Define a straight section of the profile.

The end point of the section may be edited both in Cartesian and Polar coordinates as well as in absolute or incremental coordinates. Being the incremental coordinates active, the editor will show the symbol Δ next to the affected data.

Cartesian coordinates.

The data definition area shows the following data.

Data.	Information
X1, Y1	Coordinates of the starting point of the section on each axis of the active plane at the editor.
X2, Y2	Coordinates of the end point of the section on each axis of the active plane at the editor.
Angle	Angle of the profile with the abscissa axis.
Tangency	Tangency with the previous section of the profile.

Polar coordinates.

The data definition area shows the following data.

Data.	Information
r1, θ 1	Radius and Polar angle of the section's starting point.
r2, θ 2	Radius and Polar angle of the section's end point.
Angle	Angle of the profile with the abscissa axis.
Tangency	Tangency with the previous section of the profile.

Define a curved section (clockwise or counterclockwise) of the profile.

The end point and the center of the section may be edited both in Cartesian and Polar coordinates as well as in absolute or incremental coordinates. Both points may have different types of coordinates and, besides, when using Polar coordinates, both points may have a

9.

PROFILE EDITOR

Define a new profile, enlarge an existing one or import one from a file.

FAGOR 
CNC 8060
CNC 8065

(REF: 1402)

different Polar origin. Being the incremental coordinates active, the editor will show the symbol Δ next to the affected data.

Cartesian coordinates.

The data definition area shows the following data.

Data.	Information
X1, Y1	Coordinates of the starting point of the section on each axis of the active plane at the editor.
X2, Y2	Coordinates of the end point of the section on each axis of the active plane at the editor.
Xc, Yc	Coordinates of the center of the section on each axis of the active plane at the editor.
Radius	Radius of the arc.
Tangency	Tangency with the previous section of the profile.

Polar coordinates.

The data definition area shows the following data.

Data.	Information
r1, θ 1	Radius and Polar angle of the section's starting point.
r2, θ 2	Radius and Polar angle of the section's end point.
rc, θ c	Radius and Polar angle of the section's center point.
Radius	Radius of the arc.
Tangency	Tangency with the previous section of the profile.

Start a new profile.

This softkey may be used to add a new profile to the current one, for example to define a pocket with islands.

Modify the last element of the profile.

This softkey may be used to modify the last element added to the profile.

Undo the last operation.

This softkey may be used to "undo" the last operation made.

Save and continue.

To save the profile and continue editing. Using this key does not require that the profile be completed.

9.

PROFILE EDITOR
Define a new profile, enlarge an existing one or import one from a file.



CNC 8060
CNC 8065

(REF: 1402)

9.2.2 Define a circular profile.

The softkey menu may be used to define the data in Cartesian or Polar coordinates as well as in absolute or incremental coordinates. The softkeys for these options are only available when allowed by the selected data.

Softkey.	Meaning.
Cartesian Polar	Softkey to select either Cartesian or Polar coordinates.
ABS INC	Softkey to select either absolute or incremental coordinates.
Polar origin	Softkey to define the Polar origin. The softkey is only available when Polar coordinates are active.
Direction	Direction of the profile; clockwise or counterclockwise.
Validate	Validate the profile defined.

The type of coordinates may be changed at any time and the editor will update the displayed values.

- The starting point and the center may be edited both in Cartesian and Polar coordinates, but both points must have the same type of coordinates. Therefore, a change of coordinate type affects both points. If programmed in Polar coordinates, the Polar origin will be the same for both.
- The starting point of the circle may only be edited both in absolute coordinates, whereas the center may be edited in both absolute and incremental coordinates.

Define the data of the profile.

The data definition area shows all the data needed to define a profile. The data shown by the editor depends on the active coordinate type, Cartesian or Polar. Being the incremental coordinates active, the editor will show the symbol Δ next to the affected data.

Cartesian coordinates.

The data definition area shows the following data.

Data.	Information
X1, Y1	Coordinates of the starting point of the profile on each axis of the active plane at the editor.
Xc, Yc	Coordinates of the center of the profile on each axis of the active plane at the editor.
Radius	Radius of the arc.
Direction	Direction of the profile; clockwise or counterclockwise.

Polar coordinates.

The data definition area shows the following data.

Data.	Information
r1, θ 1	Radius and Polar angle of the profile's starting point.
rc, θ c	Radius and Polar angle of the profile's center point.
Radius	Radius of the arc.
Direction	Direction of the profile; clockwise or counterclockwise.

9.

PROFILE EDITOR

Define a new profile, enlarge an existing one or import one from a file.



CNC 8060
CNC 8065

(REF: 1402)

9.2.3 Define a rectangular profile.

The softkey menu may be used to define the data in Cartesian or Polar coordinates. The softkey for this options is only available when allowed by the selected data.

Softkey.	Meaning.
Cartesian Polar	Softkey to select either Cartesian or Polar coordinates.
Polar origin	Softkey to define the Polar origin. The softkey is only available when Polar coordinates are active.
Direction	Direction of the profile; clockwise or counterclockwise.
Validate	Validate the profile defined.

The type of coordinates may be changed at any time and the editor will update the displayed values.

- The starting point may be edited both in Cartesian and Polar coordinates.
- The starting point of the rectangle can only be edited in absolute coordinates.

Define the data of the profile.

The data definition area shows all the data needed to define a profile. The data shown by the editor depends on the active coordinate type, Cartesian or Polar.

Cartesian coordinates.

The data definition area shows the following data.

Data.	Information
X1, Y1	Coordinates of the starting point of the profile on each axis of the active plane at the editor.
XL, YL	Length of the profile on each axis of the active plane at the editor.
Angle	Angle of the profile with the abscissa axis.
Direction	Direction of the profile; clockwise or counterclockwise.

Polar coordinates.

The data definition area shows the following data.

Data.	Information
r1, θ 1	Radius and Polar angle of the profile's starting point.
XL, YL	Length of the profile on each axis of the active plane at the editor.
Angle	Angle of the profile with the abscissa axis.
Direction	Direction of the profile; clockwise or counterclockwise.

9.2.4 Enlarge a profile.

The softkey menu may be used to select one of the profiles of the editor and continue building it by adding straight and curved sections. After selecting the profile, press the [ENTER] key to enter in editing mode where the softkey menu will show the options to define straight and curved sections. See "[9.2.1 Define any profile using straight and curved sections.](#)" on page 173.

9.

PROFILE EDITOR

Define a new profile, enlarge an existing one or import one from a file.



CNC 8060
CNC 8065

(REF: 1402)

9.2.5 Import a profile from a DXF file.

The DXF format is standard for exchanging graphic files. The CNC can import this type of files and, based on the contours and tool paths it contains, generate the ISO-coded blocks of the part-program.

DXF files may be imported and modified in the program editor and in the profile editor. After selecting the file, define how the various layers of the DXF file are to be interpreted.

How to draw and lay the drawing out.

How to draw the contour and other elements (items).

Element.	
Origin (zero point) of the drawing.	The CNC uses the drawing zero point as part zero.
Measuring units.	DXF files do not contain any references to measuring units (mm or inches); therefore, the CNC uses the ones defined in the part-program.
Contours.	The DXF can consist of points, lines, arcs and polylines, but they must be previously decomposed (uncombined). If the file contains polygons, they must also be decomposed; otherwise, they will be ignored.
Holes.	Drilling, tapping, etc must be represented with a single point. The CNC interprets the circles that represent the drilling, etc. as paths to be machined. To keep the look of the drawing intact, place these elements on a layer so the CNC can disable this layer when importing the drawing.

Laying the drawing out in layers.

A DXF file may be divided into layers offering the designer a way to lay the drawing out. Although each layer can contain any type of information (layers, dimensions, etc.), it must be borne in mind that the CNC uses the layers to define the order of the machining operations and the height where they will be carried out; therefore, the following rules must be followed.

- A layer must not contain profiles located at different heights. When importing the file, the CNC puts all the contents of the layer at the same machining height.
- Profiles placed at the same height may be on different layers.
- The elements that are not part of the machining operation (axes, dimensions, etc.) must be placed on layers that do not contain contours so the CNC can ignore these layers when importing the file.

Exporting the file to DXF format.

The DXF file must be in ASCII format, files in Binary format are not permitted. When generating the DXF file from the drawing program, make sure that the file is saved in ASCII format.

When generating the DXF file from the drawing program, select a 4-decimal resolution if the CNC units are millimeters or 5 decimals if the measuring units at the CNC are inches. A greater resolution increases the size of the DXF file unnecessarily because the CNC ignores the excess of resolution.

9.

PROFILE EDITOR

Define a new profile, enlarge an existing one or import one from a file.



CNC 8060
CNC 8065

(REF: 1402)

Importing a profile into the CNC.

When importing a DXF file, it shows the configuration window to define how the different layers of the drawing must be treated. The configuration window shows three areas clearly and distinctly.

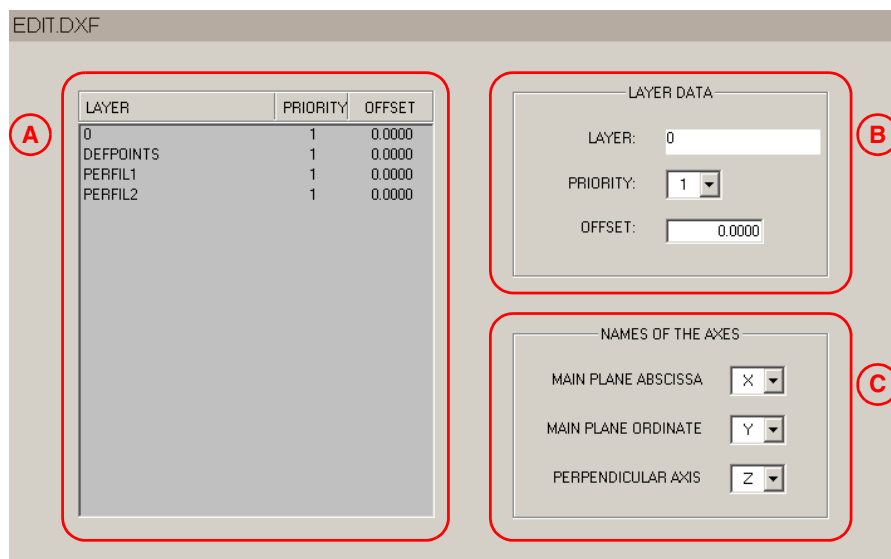

- A** List of layers of the DXF file. For each layer, it indicates its priority and offset (height) on the perpendicular axis.

When importing the file, you can decide which layers to include in the part-program. To exclude a layer, select it and press the "Disable layer" softkey.

- B** Data of the selected layer; priority and offset. Data of the layer selected with the cursor. For each layer, one must define its priority and offset (height) on the perpendicular axis.

The priority defines the order in which the layers will be executed; i.e. the order in which they will be included in the part-program. Those with priority ·1· will be executed first and so on.

The offset (height) on the perpendicular axis permits executing each layer in the desired Z coordinate (or that of the relevant perpendicular axis).

- C** Work plane. In the profile editor, the plane will be the one selected at the editor and only the perpendicular axis can be selected.

9.

PROFILE EDITOR

Define a new profile, enlarge an existing one or import one from a file.



CNC 8060
CNC 8065

(REF: 1402)

9.3 Modify a profile and insert corners

This softkey menu may be used to change the defined profiles either changing or deleting existing elements, inserting new ones or introducing rounding, chamfering and tangential entries or exits. When selecting this option, the softkey menu will show the necessary options to modify the profile.

Softkey.	Meaning.
Modify element	This softkey may be used to modify any data of a section of the profile.
Insert element	This softkey may be used to insert a new element in any position of the profile.
Delete element	This softkey may be used to delete an element of the selected profile.
Corners	This softkey may be used to include rounding, chamfers, tangential entries or exits in the defined profile.
Additional ISO	This softkey may be used to add an ISO coded line to a previously closed profile. Once the ISO coded line to be added has been entered, confirm the command by pressing the [ENTER] key.
Undo	To "undo" the last operation made.
Save and continue	To save the profile and continue editing. Using this key does not require that the profile be completed.

Modify element

This softkey may be used to modify any data of a section of the profile. Once the desired element has been selected, one may modify the type of section (straight or arc) or its data. Once the element has been modified, press "Validate" to confirm the changes.

The CNC recalculates the new profile according to the data used to define that section and the next one (tangency, angle, etc.)

Insert element

This softkey may be used to insert a new element in any position of the profile. After selecting the section after which the element is to be inserted, select the type of section (straight or arc) to be inserted, define its parameters and press the "Validate" softkey.

The CNC recalculates the new profile according to the data used to define that section and the next one (tangency, angle, etc.)

Delete element

This softkey may be used to delete an element of the selected profile. Once the element to be deleted has been selected, confirm the command by pressing [ENTER]. The CNC recalculates the new profile.

Corner definition

This softkey may be used to include rounding, chamfers, tangential entries or exits in the defined profile. When selecting this option, the softkey menu shows the type of corners that can be inserted.

Softkey.	Meaning.
Rounding	Define a rounding at the profiles corners where it is possible.
Chamfer	Define a chamfer at the corners of the profile where it is possible.
Tangential entry	Add a tangential tool entry at the beginning of the profile.
Tangential exit	Add a tangential tool exit at the end of the profile.

9.



PROFILE EDITOR
Modify a profile and insert corners

FAGOR 

CNC 8060
CNC 8065

(REF: 1402)

Once the type of corner to be inserted has been selected, the CNC will highlight in red one of the corners of the profile. Use the softkey menu or the following keys to select another element of the profile or select a corner of another profile.

Key.	Meaning.
	Select the corners of the profile.
	Select a corner of another profile.

After selecting the corner of the profile to be modified and the CNC will request the value (radius or size) of the corner.

- For a rounding, enter the rounding radius.
- For a chamfer, enter the size of the chamfer.
- For a tangential entry, enter the entry radius.
- For a tangential exit, enter the exit radius.

After defining the value of the corner, press [ENTER] to insert the corner in the profile. Then, one may select another corner or quit this mode by pressing [ESC].

9.

PROFILE EDITOR

Modify a profile and insert corners



CNC 8060
CNC 8065

(REF: 1402)

9.4 Configuring the profile editor. Displayed area.

The softkey menu of this screen may be used to modify the zoom of the graphics area. When accessing the "display area" menu, the softkey menu shows the following options:

Softkey.	Meaning.
Zoom + Zoom -	Enlarge or reduce the display area.
Optimum area	Select the best zoom, i.e. it places the profile in the center of the graphics window and selects the best zoom possible to show the whole profile.
Part zero	Keeps the part zero visible at all times.
Autozoom	Activate autozoom. When applying Autozoom, every time a new section is inserted which goes beyond the screen, the profile will automatically be centered and zoomed in or out to show the whole profile. This way, it will show the whole profile again.
Validate	Confirm the changes made.

When at the editor no menu is active to edit data or select elements, these options may be applied with their corresponding hotkeys. See "[Keyboard shortcuts.](#)" on page 169.

9.5 Configuring the profile editor. Define the work plane.

The softkey menu of this screen may be used to modify the axes of the plane and their directions. At the lathe model, the direction and position of the axes are defined by machine parameter GRAPHTYPE. When accessing the plane menu, the softkey menu shows the following options:

Softkey.	Meaning.
Abscissa axis	Select the abscissa axis.
Abscissa direction	Select the direction of the abscissa axis.
Ordinate axis	Select the ordinate axis.
Ordinate direction	Select the direction of the ordinate axis.
Validate	Confirm the changes made.

9.6 End the session at the editor.

The "End" softkey ends the profile editing session. Before exiting the profile editor, it will offer the option to save or not the edited profile.

Softkey.	Meaning.
Save profile	Insert the profile in the program and exit the profile editor. If the profile has been resolved, the CNC will insert it in the part program that is being edited. If the editor cannot resolve the profile due to lack of data, the CNC will issue the relevant message.
Do not save profile	Do not insert the profile in the program and it exit the profile editor.
Continue	Do not insert the profile in the program and continue editing the profile.

9.

9.7 Examples of how to define profiles.

9.7.1 Profile editor. Example 1 (milling).

9.

PROFILE EDITOR
Examples of how to define profiles.

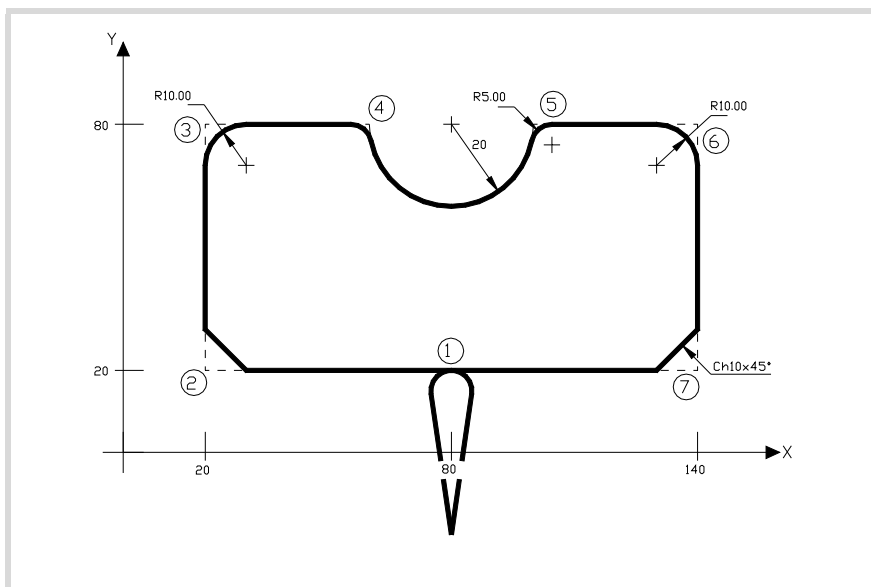

Profile definition without rounding, chamfers or tangential entries and exits.

Section.	Geometry.
Starting point	X = 80 Y = -20
Straight	X = 80 Y = 20
Straight	X = 20 Y = 20
Straight	X = 20 Y = 80
Straight	X = 60 Y = 80
Counterclockwise arc	X = 100 Y = 80 Center X = 80 Center Y = 80 Radius = 20
Straight	X = 140 Y = 80
Straight	X = 140 Y = 20
Straight	X = 80 Y = 20
Straight	X = 80 Y = -20

Definition of rounding, chamfers and tangential entries and exits

Select the "Corners" option. Press [ESC] to quit the "Corners" option.

Corner		
Tangential entry	Select point "1"	Assign radius = 5
Chamfer	Select point "2"	Assign size = 10
Rounding	Select point "3"	Assign radius = 10
Rounding	Select point "4"	Assign radius = 5
Rounding	Select point "5"	Assign radius = 5
Rounding	Select point "6"	Assign radius = 10
Chamfer	Select point "7"	Assign size = 10
Tangential exit	Select point "1"	Assign radius = 5

End of editing

Select the "END" option and save the profile. The CNC quits the profile editor and inserts the profile in the part-program.

(REF: 1402)



CNC 8060
CNC 8065

9.7.2 Profile editor. Example 2 (milling).

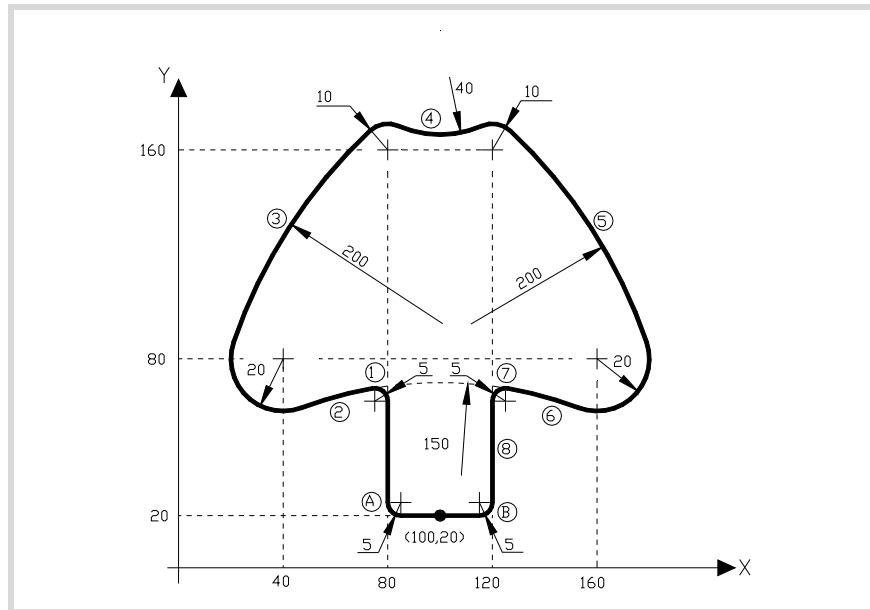

Definition of a profile without rounding.

Section.	Geometry.		
Starting point	X = 100 Y =20		
Straight	X = 80 Y =20		
Straight	X = 80	Angle = 90	
Counterclockwise arc (1)	Center X = 75	Radius = 5	Tangency = Yes
Counterclockwise arc (2)	Center X = 100	Radius = 150	Tangency = Yes
Clockwise arc	Center X = 40 Center Y = 80	Radius = 20	Tangency = Yes
			<ul style="list-style-type: none"> The CNC shows the options for section 2. Select the correct one. The CNC shows the options for section 1. Select the correct one.
Clockwise arc (3)		Radius = 200	Tangency = Yes
Clockwise arc	Center X = 80 Center Y = 160	Radius = 10	Tangency = Yes
			<ul style="list-style-type: none"> The CNC shows the options for section 3. Select the correct one.
Counterclockwise arc (4)		Radius = 40	Tangency = Yes
Clockwise arc	Center X = 120 Center Y = 160	Radius = 10	Tangency = Yes
			<ul style="list-style-type: none"> The CNC shows the options for section 4. Select the correct one.
Clockwise arc (5)		Radius = 200	Tangency = Yes
Clockwise arc	Center X = 160 Center Y = 80	Radius = 20	Tangency = Yes
			<ul style="list-style-type: none"> The CNC shows the options for section 5. Select the correct one.
Counterclockwise arc (6)	Center X = 100	Radius = 150	Tangency = Yes
			<ul style="list-style-type: none"> The CNC shows the options for section 6. Select the correct one.
Counterclockwise arc (7)	Center X = 125	Radius = 5	Tangency = Yes
			<ul style="list-style-type: none"> The CNC shows the options for section 7. Select the correct one.
Straight (8)	X = 120 Y =20		Tangency = Yes
			<ul style="list-style-type: none"> The CNC shows the options for section 8. Select the correct one.
Straight	X = 100 Y =20		

9.

PROFILE EDITOR
Examples of how to define profiles.



CNC 8060
CNC 8065

(REF: 1402)

Rounding definition "A" and "B".

Select the "Corners" option. Press [ESC] to quit the "Corners" option.

Corners.

Rounding	Select point "A"	Assign radius = 5
Rounding	Select point "B"	Assign radius = 5

End of editing

Select the "END" option and save the profile. The CNC quits the profile editor and inserts the profile in the part-program.

9.**PROFILE EDITOR**

Examples of how to define profiles.



CNC 8060
CNC 8065

(REF: 1402)

9.7.3 Profile editor. Example 3 (milling).

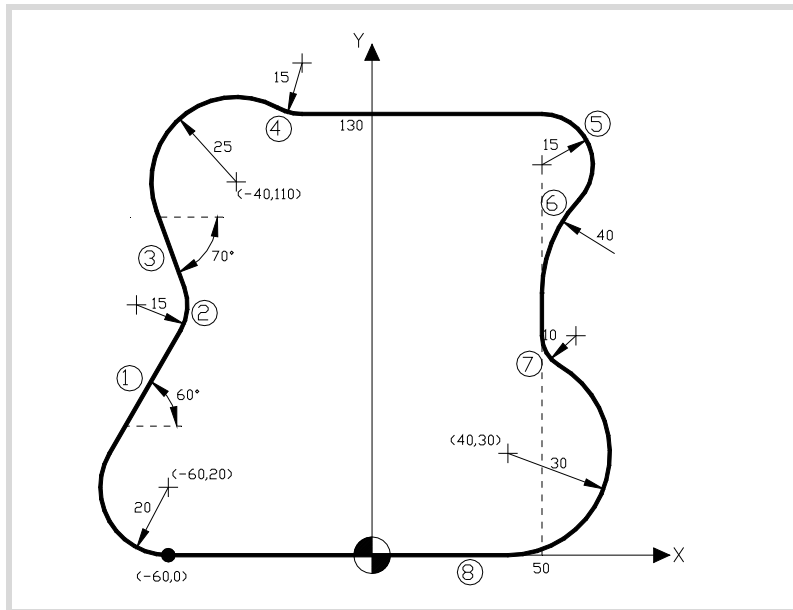

Profile definition.

Section.	Geometry.		
Starting point	X = -60 Y = 0		
Clockwise arc	Center X = -60 Center Y = 20	Radius = 20	
Straight (1)		Angle = 60	Tangency = Yes
• The CNC shows the options for section 1. Select the correct one.			
Counterclockwise arc (2)		Radius = 15	Tangency = Yes
Straight (3)		Angle = -70	Tangency = Yes
Clockwise arc (3)	Center X = -40 Center Y = 110	Radius = 25	Tangency = Yes
• The CNC shows the options for section 3. Select the correct one.			
• The CNC shows the options for section 2. Select the correct one.			
Counterclockwise arc (4)		Radius = 15	Tangency = Yes
Straight (4)	Y = 130	Angle = 0	Tangency = Yes
• The CNC shows the options for section 4. Select the correct one.			
Clockwise arc (5)	Center X = 50	Radius = 15	Tangency = Yes
• The CNC shows the options for section 5. Select the correct one.			
Counterclockwise arc (6)		Radius = 40	Tangency = Yes
Straight (6)	X = 50	Angle = 270	Tangency = Yes
• The CNC shows the options for section 6. Select the correct one.			
Counterclockwise arc (7)		Radius = 10	Tangency = Yes
Clockwise arc (7)	Center X = 40 Center Y = 30	Radius = 30	Tangency = Yes
• The CNC shows the options for section 7. Select the correct one.			
Straight (8)	X = -60 Y = 0		Tangency = Yes
• The CNC shows the options for section 8. Select the correct one.			

End of editing

Select the "END" option and save the profile. The CNC quits the profile editor and inserts the profile in the part-program.

9.

PROFILE EDITOR
Examples of how to define profiles.



CNC 8060
CNC 8065

(REF: 1402)

9.7.4 Profile editor. Example 4 (lathe)

9.

PROFILE EDITOR

Examples of how to define profiles.

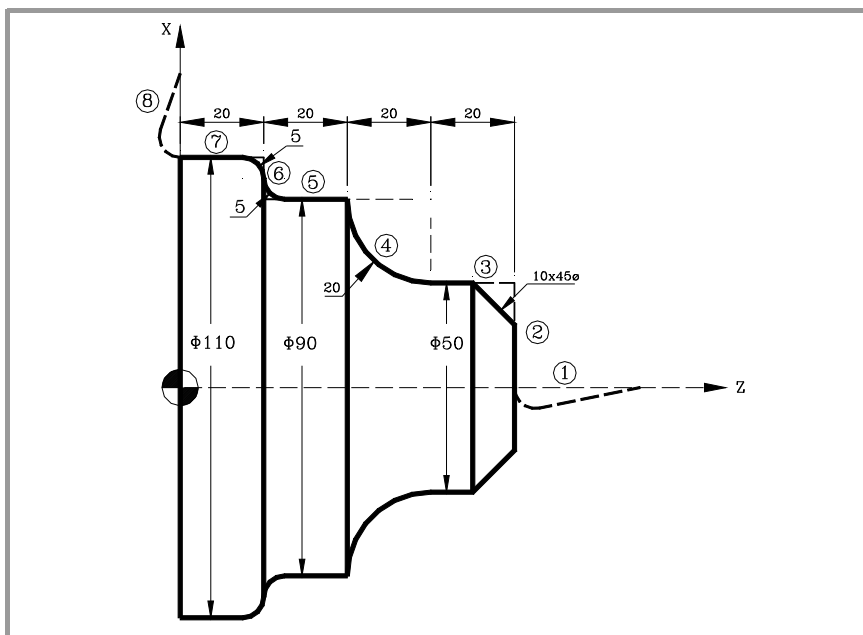

Profile definition without rounding, chamfers or tangential entries and exits.

Section.	Geometry.
Starting point	Z = 100 X = 0
Straight (1)	Z = 80 X = 0
Straight (2)	Z = 80 X = 50
Straight (3)	Z = 60 X = 50
Clockwise arc (4)	Z = 40 X = 90 Center Z = 60 Center X = 90 Radius = 20
Straight (5)	Z = 20 X = 90
Straight (6)	Z = 20 X = 110
Straight (7)	Z = 0 X = 110
Straight (8)	Z = 0 X = 150

Definition of rounding, chamfers and tangential entries and exits

Select the "Corners" option. Press [ESC] to quit the "Corners" option.

Corners.		
Tangential entry	Select the corner "1-2"	Assign radius = 5
Chamfer	Select the corner "2-3"	Assign size = 10
Rounding	Select the corner "5-6"	Assign radius = 5
Rounding	Select the corner "6-7"	Assign radius = 5
Tangential exit	Select the corner "7-8"	Assign radius = 5

End of editing

Select the "END" option and save the profile. The CNC quits the profile editor and inserts the profile in the part-program.



CNC 8060
CNC 8065

(REF: 1402)

10.1 Description of the graphic environment.

The graphic environment displays a graphic representation of the program that is being executed or simulated and take measurements on the graphics.

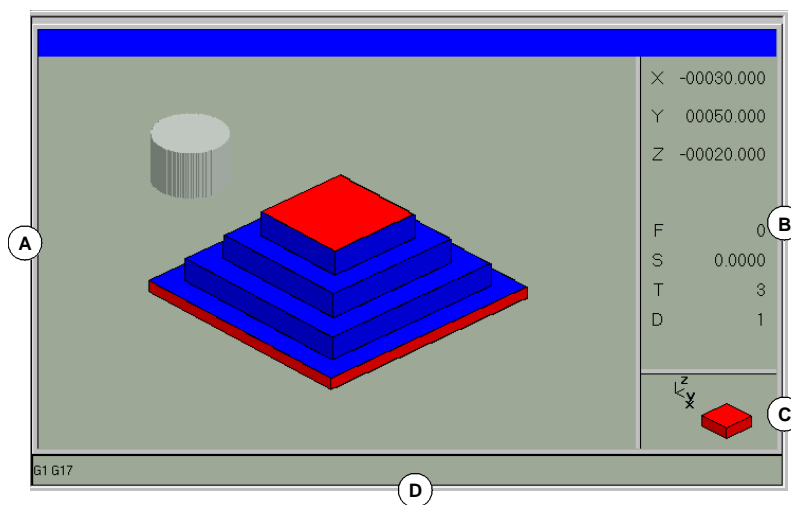

A Display area.

Shows a graphic representation of the tool paths or of the part as the program is being executed or simulated.

B Dialog area.

Shows the position of the axes and the machining conditions active in the execution or simulation (feedrate, spindle speed, tool and tool offset).

When selecting specific options of the softkey menu, it shows the information associated with that option which may be defined by the user.

C Information area.

Shows the work plane appearing in the display area and an illustration representing the size of the graph and the portion of the graphic area selected with the zoom.

On 3D graphics, the illustration shows the point of view of the graph displayed and it may be changed by the operator.

Key.	Meaning.
	Select a new point of view.
	Assumes the new point of view selected.
	Cancel the selected point of view.

D This area only appears during simulation and shows the "G" functions active in the simulation.

10.1.1 Softkey menus.

Vertical softkey menu.

The vertical softkey menu shows the options related to the operating mode that called upon the graphic environment (EDISIMU mode for simulation, automatic mode for execution, etc.).

Horizontal softkey menu (graphic area).

When selecting this area, the horizontal softkey menu shows the necessary options for interacting with graphics.

Softkey.	Description.
"Type of graphics"	Select the type of graphics.
"ZOOM"	Enlarge or reduce the whole graph shown or part of it.
"Dimensions"	Define the size of the graphics representation.
"Point of view"	Change the point of view of the graph and show it from another perspective.
"Measurement"	Measure the distance between two points.
"Clear screen"	Clear the screen or delete the graphics displayed.
"Colors"	Set the appearance of the graphics on display.
"Options"	Set the appearance and some options of the graphic window.
" +Real"	Display either the real or the theoretical tool path.
" +Error"	Display the real path, but enlarging the error with respect to the theoretical path. Pressing this softkey also activates the one corresponding to the real path.
"Speed"	Change the simulation speed.

10.

GRAPHIC ENVIRONMENT (MILL MODEL)
 Description of the graphic environment.



CNC 8060
CNC 8065

(REF: 1402)

10.2 Type of graphics

When selecting this option, the softkey menu shows the types of graphics available. The various types of graphics may be line (3D lines, XY, XZ, YZ and Combined) or solid (Sections and 3D solid). Line graphics show the tool path with lines of different colors and solid graphics show an image of the part.

The type of graphics selected will remain active until another type is selected or the graphic display is deactivated or the CNC is turned off. Likewise, when changing the type of graphics, the CNC will maintain the graphic conditions (zoom, graphic parameters, display area, etc.), defined for the last graphic.

"3D lines" Graphics

This type of graphics displays a three-dimensional graph of the tool paths.

"Sections" Graphics

This type of graphic displays a top view (XY plane) of the part; it shows the machining depths in different tones. It also displays the XZ and YZ sections for the areas shown by the indicators of the top view.

These indicators may be moved around using the [↑][↓][←][→] keys, to display the different sections of the part. The CNC shows dynamically the new section being selected.

The indicators may be moved at any time even while executing the program.

"XY" - "XZ" - "YZ" graphics

This type of graphic displays the tool paths in the XY, XZ or YZ plane.

"Combined" graphics

This type of graphic divides the display area in four quadrants and displays the tool path corresponding to each plane XY, XZ, YZ and to the 3D view.

"Solid 3D" Graphics





This type of graphics displays a three-dimensional graph of the machining of the part. Starting out with a 3D block which is "machined" as the program is executed or simulated.

10.

10.3 Zoom

The zoom option may be used to enlarge or reduce the whole graph shown or part of it. This option is not available in the "Combined" type of graphics.

After selecting the "Zoom" option, a zoom frame will appear over the graphics. This frame may be enlarged, reduced and moved around over the graphics already displayed in order to select a particular portion of it to zoom into or out of.

Key.	Meaning.
 	To move the zoom frame around.
	To change the size of the zoom frame.
	To validate and display the selected zoom area.

The graphics at the lower right-hand side of the screen shows two figures. The one shown with lines only, indicates the dimensions of the display area and the one with colored sides indicates the portion selected with the zoom.



When selecting this option, the softkey menu shows the available zoom options. To return to the main menu, press the [BACK] key.

Zoom "Initial"

This option restores the size of the display area set via program or using the "Dimensions" option.

Zoom "Automatic"

The CNC uses the zoom that it considers best according to the movements programmed.

Zoom "Previous"

This option displays up to two zooms defined earlier. After the second one, it shows again the one defined last.

Zoom "Limits"

Only for the "Sections" type. In this graphics, zooming is done by moving the indicators that appear framing the graphic sections.

With this option, it is possible to select the axis whose indicator is to be moved. The indicator may also be selected with the [+] and [-] keys of the numeric keyboard in a rotary fashion (Xmin, Xmax, Ymin, Ymax, Zmin, Zmax).

Zoom "Edit"

It is used to manually edit the zoom values. It is edited in the dialog area of the graphic window that shows the dimensions of the zoom frame

10.

10.4 Dimensions

This softkey is used to define the size of the graphic representation by setting the maximum and minimum coordinates of the graphics on each axis.



When selecting this option, the softkey menu shows the options available for setting the dimensions. To return to the main menu, press the [BACK] key.

Dimensions "Automatic"

The CNC sets the dimensions that it considers best according to the movements programmed.

Dimensions "Edit"

The CNC lets manually edit the dimension values. It is edited in the graphic window that shows the dimensions of the graphics on each axis.

10.5 Point of view

This softkey is used to select the point of view on 3D graphics. This option is only available for the types of graphics "Combined", "3D lines", "Sections" and "Solid 3D".

The orientation of the graphics may be directly selected at the graphic window by orienting the XY plane and the Z axis. The XY plane may be rotated 360° and the Z axis 90°. The figure at the lower right-hand side of the screen shows the point of view currently selected.

Key.	Meaning.
	To orient the XY plane.
	To orient the Z axis.
	To validate and display the selected point of view.
	To cancel the selected point of view.



When selecting this option, the softkey menu shows the options available for selecting the point of view. To return to the main menu, press the [BACK] key.





Point of view "Edit"

It is used to manually edit the orientation of the axes of the graphics. It is edited in the dialog area of the graphic window that shows the current orientation of the axes.

10.6 Measurement

This softkey may be used to measure the distance between two points. This option is only available for the types of graphics "XY", "XZ", "YZ" and "Solid 3D".

When selecting this option, the section being measured will appear on the graphics with two cursors and a dashed line. The cursor currently selected will appear in red.

Key.	Meaning.
   	To move the zoom frame around.
	To change the size of the zoom frame.

The dialog area will show the coordinates of both cursors, the distance between them on the straight line and the components of that distance on the axes of the active plane. The coordinates of the selected cursor will appear in red.



When selecting this option, the softkey menu shows the available options. To return to the main menu, press the [BACK] key.

Measurement "Point1" & "Point2"

This option is used to select the cursor to be moved (same as using the [+] key).

Measurement "Edit"

This option is used to manually edit the position of the cursors. It is edited in the dialog area of the graphic window that shows the position of both cursors.

10.

GRAPHIC ENVIRONMENT (MILL MODEL)
Measurement



CNC 8060
CNC 8065

(REF: 1402)

10.7 Clear screen

This softkey is used to clear the screen or delete the graphics displayed. If a solid graphic type is selected, the graphic representation will be reset and it will return to its initial state without machining.

10.8 Colors

This softkey is used to change the colors used in the graphic representation.

- In the line graphics, it is possible to choose the color for each type of tool path; the color for rapid movements, paths with tool compensation, etc.

The real coordinates are only available for the execution of the program. The real coordinate is the actual position of the tool which differs from the command coordinate in the amount of following error (axis lag).

- In solid graphics, only the color of each side of the solid may be selected.



When selecting this option, the softkey menu shows the available options. To return to the main menu, press the [BACK] key.

Colors "Apply"

It assumes the new colors and applies them to the blocks drawn next. If the new colors are not applied, the graphics are drawn with the old colors.

Colors "Edit"

It is used to select the new colors for the graphics. They are selected in the dialog area of the graphic window that show the current colors.

Key.	Meaning.
	To move the cursor through the data.
	To open and close the color palettes.
	To move the cursor through the colors of the palette.
	To cancel the selected colors.

10.

GRAPHIC ENVIRONMENT (MILL MODEL)
Clear screen

10.9 Options

This softkey is used to set the appearance and some functions of the graphic window. These options may be used at any time, even while executing a program.



When selecting this option, the softkey menu shows the available options. To return to the main menu, press the [BACK] key.

Option "Activate"

This softkey may be used to activate the graphics. The softkey appears pressed when this option is enabled. The status of this softkey cannot be modified while executing or simulating a program.

When the graphic representation is deactivated and activated, the current graphic is erased; but the display conditions are kept active (type of graphics, zoom, graphic parameters and display area) that were active before that mode was deactivated.

Option "Simple"

This softkey shows the single window for graphics. The softkey appears pressed when this option is enabled.

The single window hides the dialog and data areas on the right-hand side of the graphic window so the drawing occupies the whole graphic window.

Option "Hide Tool"

This softkey is used to hide or show the tool while simulating in "3D solid" graphics. The softkey appears pressed when this option is enabled.

Lathe tools are never displayed regardless of the status of this softkey. When it is a lathe tool, this softkey may be activated to hide the tool, but it cannot be deactivated to show the tool.

Option "Print"

This softkey may be used to print the graphics in the pre-determined printer or save it as a file (bmp format) at the CNC. When selecting the "File" option, it will be saved in the folder "C:\Cnc8070\Users\Reports\"; the file name may be selected using the "Print configuration" softkey.

When selecting this option, the CNC will show a dialog box requesting the print destination (printer or file). After selecting the destination, press [ENTER] to print it or [ESC] to cancel it.

Option "Print setup"

It is used to set the printing configuration. When selecting this option, the CNC shows a dialog box where the following may be defined:

- The title of the graphics that will appear next to it in the print.
- The name of the file where the graphics will be stored when printing out to a file.

After filling out the data, press [ENTER] to accept them or [ESC] to cancel them.

10.

Options
GRAPHIC ENVIRONMENT (MILL MODEL)



CNC 8060
CNC 8065

(REF: 1402)

10.10 Real coordinates

This softkey is used to draw the real tool path or the theoretical tool path. This option is only available in line type graphics.

This option is only available when executing the program; not when simulating it. When selecting this option (the softkey will appear pressed), the CNC draws the actual (real) tool path.

10.11 Real coordinates with enlarged error

This softkey shows the real path, but enlarging the error with respect to the theoretical path. The error enlargement factor may be set after pressing the softkey.

This option is only available when executing the program; not when simulating it. When selecting this option (the softkey will appear pressed), the CNC draws the actual (real) tool path with enlarged error. Pressing this softkey also activates the one corresponding to the real path.

10.12 Simulation speed

This softkey is used to change the simulation speed.



When selecting this option, the softkey menu shows the options to set the simulation speed. To return to the main menu, press the [BACK] key.

This option is only available when simulating the program; not when executing it.

Speed "Edit"

It is used to select the new simulation speed. It is selected using the graduated ruler that indicates the active simulation speed.

Key.	Meaning.
	To move the ruler cursor.

10.

GRAPHIC ENVIRONMENT (MILL MODEL)
Real coordinates

FAGOR

CNC 8060
CNC 8065

(REF: 1402)

10.

GRAPHIC ENVIRONMENT (MILL MODEL)

Simulation speed



CNC 8060
CNC 8065

(REF: 1402)

11.1 Description of the graphic environment.

The graphic environment displays a graphic representation of the program that is being executed or simulated and take measurements on the graphics.

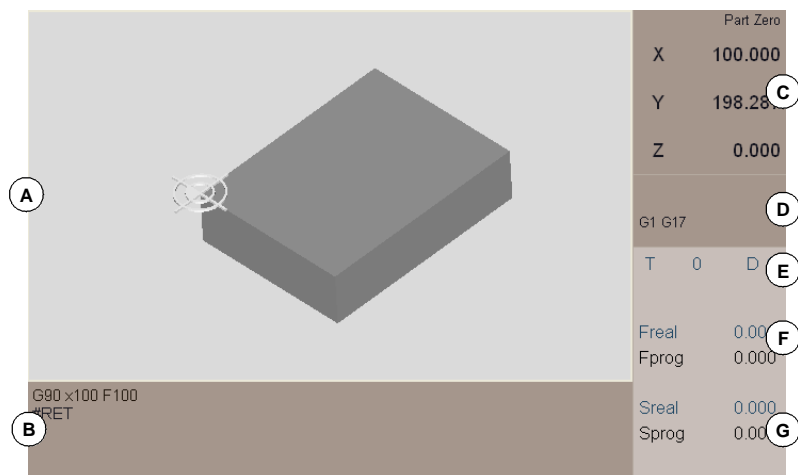

- A** Display area. Shows a graphic representation of the tool paths or of the part as the program is being executed or simulated.
- B** Blocks of the program or subroutine being executed. During execution, the cursor shows the block being executed.
- C** Current axis position referred to part zero, referred to the tool tip.
- D** Active "G" functions.
- E** Tool related information; tool number "T" and tool offset "D".
- F** Information related to the feedrate "F" of the axes:
 - "F real" Real (actual) feedrate of the axes.
 - "F prog" Programmed feedrate.
- G** Information related to the spindle speed "S".
 - "S real" Real (actual) spindle speed.
 - "S prog" Programmed speed.

11.1.1 Softkey menus.

Vertical softkey menu.







The vertical softkey menu shows the options related to the operating mode that called upon the graphic environment (EDISIMU mode for simulation, automatic mode for execution, etc.).

Horizontal softkey menu (program area).

When selecting this area, the horizontal softkey menu shows the necessary options for simulating (EDISIMU mode) or executing the program (automatic mode).

Horizontal softkey menu (graphic area).

When selecting this area, the horizontal softkey menu shows the necessary options for interacting with graphics.

Softkey.	Function.
	Select the type of view.
	Configure the graphics (number of windows, colors, etc.).
	Actions.
	Delete the graphic.
	Define the parts and the size of the graphic.
	Measure the part.
	Views. Simulation speed.

11.

HD GRAPHIC ENVIRONMENT (MILL MODEL)
 Description of the graphic environment.



CNC 8060
CNC 8065





(REF: 1402)

11.2 Move, rotate and zoom in or out on the graphic.

When no option has been selected on the softkey menu, it is possible to act upon the graphic as follows.

Move the graphic.

To move the part of the active view, move the mouse while holding its right button or use the following keys.

Key.	Meaning.
 	Move the part to the left or to the right.
 	Move the part up or down.

Rotate the graphic.

To rotate the part of the active view, move the mouse while holding its left button or use the following keys [↑][↓][←][→].

Zoom the graphic.

To zoom in or out on the active view, turn the mouse wheel or use the [+][-] keys.

11.

HD GRAPHIC ENVIRONMENT (MILL MODEL)

Move, rotate and zoom in or out on the graphic.

FAGOR 

**CNC 8060
CNC 8065**

(REF: 1402)

11.3 Select the type of view.

This option is used to select the point of view of the part. Since the screen may be divided into 4 windows, the softkey only affects the active window (the one having the focus). The screen may be selected with the tab key or with the keys [1] through [4] (depending on the window to be selected).

- Top view.
- Front view.
- Left view.
- Right view.
- First user view.
- Second user view.
- Save the current view as user view.
- Select the part to be displayed.

User views.

The top view, front view and side views are predetermined views that may be moved or rotated with the mouse or with the following keys.

Key.	Meaning.
	Rotate the part.
	Move the part to the left or to the right.
	Move the part up or down.

The new position and orientation of the part may be saved as a user view. The CNC keeps the saved user views even after being turned off.

Select the part to be displayed.

The graphics may have defined up to four different parts. Each of the four windows that the screen may be divided into may display the same part or different parts. The following softkeys only affect the active window (the one having the focus).

Softkey.	Function.
	General view of all the parts.
	See the first part that the active channel is working on. When changing channels, the displayed part changes. If several channels are working on the same part, all of them can show the same part.
	View the first part. The menu shows a softkey per available part.

11.

HD GRAPHIC ENVIRONMENT (MILL MODEL)
Select the type of view.







CNC 8060
CNC 8065

(REF: 1402)

11.4 Configure the graphics (number of windows, colors, etc.).

This option is used to configure the graphic environment and each window.

Softkey.	Function.
	Configuration of the active window (properties of each window).
	Configuration of the sections.
	Configuration of the colors for the part and for the tool paths.
	General configuration of the graphics.
	Cancel the graphics.

Configuration of the windows (properties of each window).

This softkey is used to configure the properties of the active window so each of the four windows the screen may be divided into, may have different properties. For example, a window may show only the part to be machined and another one only the machining tool paths. The screen may be selected with the tab key or with the keys [1] through [4] (depending on the window to be selected).

Properties.	Meaning.
View part.	The graphic shows the solid part to be machined.
View tool path.	The graphic shows the machining lines.
View machine.	Not being used.
View tool colors.	The graphic shows the machining of each tool in the color defined in the color configuration.
View axes.	The graphic shows the first three axes of the channel set as origin channel for the part. These axes make up the coordinate system used to reference the part and its origin coincides with part zero.
View sections.	The graphic enables the sections, those marked as active in the configuration of the sections.
Enhance part edges.	The graphic enhances the edges of the displayed part.

Configuration of the sections.

This option is used to defined up to three planes to cut the graphic. The sections are global to all the defined parts. If there is a section defined in X100, it will cut all the parts that have that coordinate in their dimensions.

The definition of the sections is global for all the defined windows, but each window may have different sections active. To view the sections in a window, one must also enable the "view sections" option in the window properties.

Define the sections.

Each section (cutting plane) is defined using its origin point and a normal vector that defines its orientation. Both data appear on the section configuration page as "Origin" and "Normal". The color of each section may also be defined.

11.

HD GRAPHIC ENVIRONMENT (MILL MODEL)
Configure the graphics (number of windows, colors, etc.).

FAGOR 

CNC 8060
CNC 8065

(REF: 1402)

The default values define three sections, each of them perpendicular to one of the axes and cut the part in half.

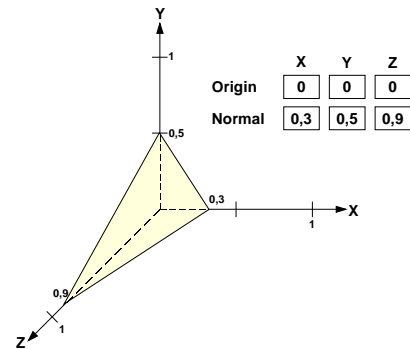
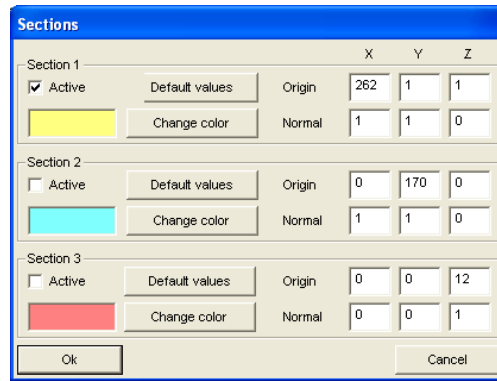

Activate the sections.

Each section may be activated individually. The definition of active windows only affect the active window (the one having the focus).

To view the sections on the graphic, one must also enable the "view sections" option in the window properties. If the "view sections" option is not enabled, the graphic does not show any section even if they are active. If the "view sections" option is not enabled, the graphic shows the active sections separately.

Color configuration.

This softkey is used to configure the colors for the part and for the tool paths. This configuration is global for all the windows.

Path colors.

This option is used to assign colors to the following tool paths.

- Rapid traverse (G0).
- Compensated movements.
- Uncompensated movements.
- Canned cycles.
- Tapping.

Part colors.

This option is used to change the background colors, the colors of the machined areas and the look of the part. The selected values remain until the CNC is turned off.

- Background color.
- Color of the machining operations carried out with the first five tools used on the graphic. Here only the colors are defined, to display them, the "view tool colors" option must be active in the properties of the view.
- Material used to represent the solid part. The "Advanced" button may be used to change the properties of the selected material. Besides the various color components (diffuse, ambient, etc.), the brightness and transparency of the part can also be defined. Transparency may take values between 0 and 1. If the value of the transparency is other than zero, the solid part becomes transparent.

General configuration of the graphics.

This softkey may be used to configure the global properties of the graphic environment, those affecting all the windows.

Number of windows.

The graphic environment may be a full-screen window or may be divided into 2 or 4 windows, each with different properties (for example a different view of the part). The screen may be

11.

HD GRAPHIC ENVIRONMENT (MILL MODEL)
Configure the graphics (number of windows, colors, etc.).



CNC 8060
CNC 8065

(REF: 1402)

selected with the tab key or with the keys [1] through [4] (depending on the window to be selected).

Graphic parameters.

The "Advanced" button may be used to change the following parameters that affect the speed and quality of the graphic. The higher the value of these parameters, the better the graphic quality but slower drawing speed.

- Machining accuracy.
- Refresh speed.

Simulation speed.

When simulating a program (from EDISIMU mode), the simulation speed can also be defined. It is not possible during execution (automatic mode).

11.

HD GRAPHIC ENVIRONMENT (MILL MODEL)

Configure the graphics (number of windows, colors, etc.).





CNC 8060
CNC 8065

(REF: 1402)

11.5 Actions (move sections and print graphics).

The softkey menu may be used to carry out the following actions.

Softkey.	Function.
	Move the active sections.
	Print the graphic out to the predetermined printer or out to a file.

Move the active sections.

This option may be used to move the active sections. To move the sections, the active view must have the "view sections" option enabled and it must also have a section active. To end the possibility to move sections, press the [ESC] key or press the same softkey again. With this option active, the bottom of the screen shows a message indicating the active section and its data.

Select and move the sections.

One of the sections is always selected. To change the section to be moved, use the tab key or with the [1] [2] [3] keys (depending on the section number). The section to be moved appears in orange and the rest in the color they have been defined with.

Moving a section is actually changing its origin point which is the point in space defined by its three coordinates X Y Z. Therefore, moving a non-perpendicular section requires knowing which coordinate of the origin point is to be moved.

If the section to be moved is perpendicular to one of the axes of the trihedron, like the default sections, the [↑][→] keys move the section in the positive direction of the axis and the [↓][←] keys move it in the negative direction of the axis.

If the section is not perpendicular to any of the axes of the trihedron, it is necessary to select one of the axes of the trihedron (hold one of the keys [X] [Y] [Z] down) and use the [↑][→] keys move the section in the positive direction of the axis and the [↓][←] keys move it in the negative direction of the axis.

Print the graphic.

This option may be used to print the graphic out to the predetermined printer or out to a file.

Print the graphic.

This softkey may be used to print the graphics in the pre-determined printer or save it as a file (bmp format) at the CNC. When printing the graphic to a file, it will be saved in the folder "C:\Cnc8070\Users\Reports\"; the file name may be selected using the "Print configuration" softkey.

When selecting this option, the CNC will show a dialog box requesting the print destination (printer or file). After selecting the destination, press [ENTER] to print it or [ESC] to cancel it.

Print configuration.

This softkey may be used to set the printing properties. When selecting this option, the CNC shows a dialog box where the following may be defined:

- The title of the graphics that will appear next to it in the print.
- The name of the file where the graphics will be stored when printing out to a file.

After filling out the data, press [ENTER] to accept them or [ESC] to cancel them.

11.

HD GRAPHIC ENVIRONMENT (MILL MODEL)
Actions (move sections and print graphics).



CNC 8060
CNC 8065



(REF: 1402)

11.6 Delete the graphic.

This option deletes the graphic representation; deletes the drawn tool paths and resets the solid to its initial dimensions.

11.7 Define the dimensions of the parts and the size of the graphic.

This option may be used to define the parts to be used on the graphics. The graphics may display up to four different parts at the same time and it is possible to work with all of them at the same time or with each one separately. Each of the parts may be referred to a different origin, associated with a particular channel and have different zero offsets.

Softkey.	Function.
	Edit and display the parts.
	Automatic dimensions.

Edit and display the parts.

This softkey shows the following box of options.

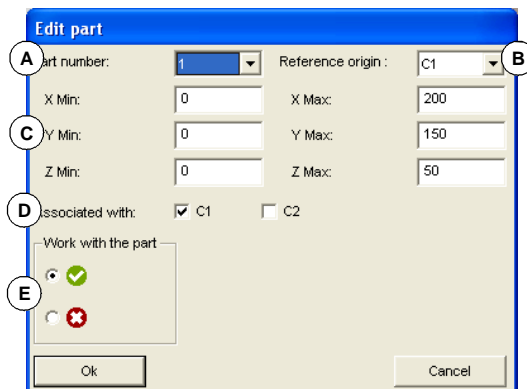

- A Part number.
- B Channel used to define the origins and the dimensions. The box will show the axes of the selected channel.
- C Part dimensions. To include a zero offset in the part, edit the zero offset at the minimum values of the axes.
- D Channels the part is associated with, to display it. Since several channels may work on a part, in order to be able to keep displaying the machining of that part when changing channels, it is necessary to define which channels are working on that part.
- E Display or hide the defined part.

Automatic dimensions.

The CNC sets the dimensions that it considers best according to the movements programmed.

11.

HD GRAPHIC ENVIRONMENT (MILL MODEL)
Delete the graphic.

11.8 Measure the part.

This option may be used to measure the distance between two points. Once measured, press the [ESC] key or press the same softkey again.

If it is a 3D view, the measuring points are always inside the a surface of the part. If it is a 2D view, the measuring points may be out of the limits of the part. Only distances external to the part may be measured in 2D views (tool path measuring).

When selecting this option, two measuring points appear on the graphic joined by a dashed line that represents the distance to measure. These measuring points are visible in all the views, but the actions are carried out in the active view.

Select and move the measuring points.

One of the measuring points is always active; to change the active measuring point, use the tab key or place the cursor on it. The CNC shows the active measuring point in a different color.

The active measuring point may be moved with the mouse or with the [↑][↓][←][→] keys. With the mouse, click on one point of the screen, the active measuring point moves to that point automatically. Also with the mouse, place the cursor on the measuring point and click the left button, drag it to the measuring point.

11.9 Simulation speed.

This option may be used to change the simulation speed, same as from the graphics configuration menu. After activating this option, the CNC shows a cursor for setting the simulation speed. To move the cursor, use the mouses or the [SHIFT][←] or [SHIFT][→] keys.

Simulation speed ————— **75** ————— +

11.

HD GRAPHIC ENVIRONMENT (MILL MODEL)
Measure the part.



CNC 8060
CNC 8065

(REF: 1402)

12.1 Description of the graphic environment.

The graphic environment displays a graphic representation of the program that is being executed or simulated and take measurements on the graphics.

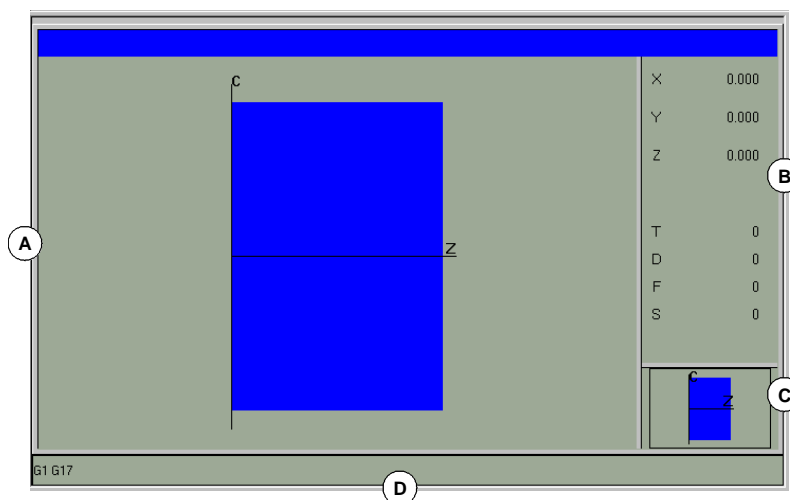

- A** Display area.
Shows a graphic representation of the tool paths or of the part as the program is being executed or simulated.
- B** Dialog area.
Shows the position of the axes and the machining conditions active in the execution or simulation (feedrate, spindle speed, tool and tool offset).
When selecting specific options of the softkey menu, it shows the information associated with that option which may be defined by the user.
- C** Information area.
Shows the work plane appearing in the display area and an illustration representing the size of the graph and the portion of the graphic area selected with the zoom.
- D** This area only appears during simulation and shows the "G" functions active in the simulation.

12.1.1 Softkey menus.

Vertical softkey menu.

The vertical softkey menu shows the options related to the operating mode that called upon the graphic environment (EDISIMU mode for simulation, automatic mode for execution, etc.).

Horizontal softkey menu (graphic area).

When selecting this area, the horizontal softkey menu shows the necessary options for interacting with graphics.

Softkey.	Description.
"Type of graphics"	Select the type of graphics.
"ZOOM"	Enlarge or reduce the whole graph shown or part of it.
"Dimensions"	Define the size of the graphics representation.
"Measurement"	Measure the distance between two points.
"Clear screen"	Clear the screen or delete the graphics displayed.
"Colors"	Set the appearance of the graphics on display.
"Options"	Set the appearance and some options of the graphic window.
" +Real"	Display either the real or the theoretical tool path.
" +Error"	Display the real path, but enlarging the error with respect to the theoretical path. Pressing this softkey also activates the one corresponding to the real path.
"Speed"	Change the simulation speed.

12.

GRAPHIC ENVIRONMENT (LATHE MODEL)
Description of the graphic environment.



CNC 8060
CNC 8065

(REF: 1402)

12.2 Type of graphics

When selecting this option, the softkey menu shows the types of graphics available. The various types of graphics may be grouped into line graphics (XZ, XC, ZC and combined) and solid graphics (Solid XZ, Solid XC, Solid ZC). Line graphics show the tool path with lines of different colors and solid graphics show an image of the part.

The type of graphics selected will remain active until another type is selected or the graphic display is deactivated or the CNC is turned off. Likewise, when changing the type of graphics, the CNC will maintain the graphic conditions (zoom, graphic parameters, display area, etc.), defined for the last graphic.

"XZ" - "XC" - "ZC" graphics

This type of graphic displays the tool paths in the XZ, XC or ZC plane.

"Combined" graphics

This type of graphic divides the display area in four quadrants and displays the tool path corresponding to each plane planos XZ, XC or ZC.

"Solid 3D" Graphics







This type of graphics displays a three-dimensional graph of the machining of the part. Starting out with a solid block which is "machined" as the program is executed or simulated.

12.

12.3 Zoom

The zoom option may be used to enlarge or reduce the whole graph shown or part of it. This option is not available in the "Combined" type of graphics.

After selecting the "Zoom" option, a zoom frame will appear over the graphics. This frame may be enlarged, reduced and moved around over the graphics already displayed in order to select a particular portion of it to zoom into or out of.

Key.	Meaning.
   	To move the zoom frame around.
 	To change the size of the zoom frame.
	To validate and display the selected zoom area.

A window is displayed on the graphics at the lower right-hand side of the screen. This window indicates the graphic area selected with the zoom.



When selecting this option, the softkey menu shows the available zoom options. To return to the main menu, press the [BACK] key.

Zoom "Initial"

This option restores the size of the display area set via program or using the "Dimensions" option.

Zoom "Automatic"

The CNC uses the zoom that it considers best according to the movements programmed.

Zoom "Previous"

This option displays up to two zooms defined earlier. After the second one, it shows again the one defined last.

Zoom "Edit"

It is used to manually edit the zoom values. It is edited in the dialog area of the graphic window that shows the dimensions of the zoom frame

12.

GRAPHIC ENVIRONMENT (LATHE MODEL) Zoom



CNC 8060
CNC 8065

(REF: 1402)

12.4 Dimensions

It is used to define the size of the graphic representation by setting the inside and outside diameters of the part and the maximum and minimum coordinates of the graphics on the longitudinal axis.



When selecting this option, the softkey menu shows the options available for setting the dimensions. To return to the main menu, press the [BACK] key.

Dimensions "Automatic"

The CNC sets the dimensions that it considers best according to the movements programmed.

Dimensions "Edit"

The CNC lets manually edit the dimension values. It is edited in the dialog area of the graphic window that shows the dimensions of the graphics.

12.5 Measurement

This softkey may be used to measure the distance between two points. This option is not available in the "Combined" type of graphics.

When selecting this option, the section being measured will appear on the graphics with two cursors and a dashed line. The cursor currently selected will appear in red.

Key.	Meaning.
	To move the zoom frame around.
	To change the size of the zoom frame.

The dialog area will show the coordinates of both cursors, the distance between them on the straight line and the components of that distance on the axes of the active plane. The coordinates of the selected cursor will appear in red.



When selecting this option, the softkey menu shows the available options. To return to the main menu, press the [BACK] key.

Measurement "Point1" & "Point2"

This option is used to select the cursor to be moved (same as using the [+] key).

Measurement "Edit"

This option is used to manually edit the position of the cursors. It is edited in the dialog area of the graphic window that shows the position of both cursors.

12.6 Clear screen

This softkey is used to clear the screen or delete the graphics displayed. If a solid graphic type is selected, the graphic representation will be reset and it will return to its initial state without machining.

12.7 Colors

This softkey is used to change the colors used in the graphic representation.

- In the line graphics, it is possible to choose the color for each type of tool path; the color for rapid movements, paths with tool compensation, etc.

The real coordinates are only available for the execution of the program. The real coordinate is the actual position of the tool which differs from the command coordinate in the amount of following error (axis lag).

- In solid graphics, it is possible to choose the color of the solid, of the tool, etc.



When selecting this option, the softkey menu shows the available options. To return to the main menu, press the [BACK] key.

Colors "Apply"

It assumes the new colors and applies them to the blocks drawn next. If the new colors are not applied, the graphics are drawn with the old colors.

Colors "Edit"

It is used to select the new colors for the graphics. They are selected in the dialog area of the graphic window that show the current colors.

Key.	Meaning.
	To move the cursor through the data.
	To open and close the color palettes.
	To move the cursor through the colors of the palette.
	To cancel the selected colors.

12.

GRAPHIC ENVIRONMENT (LATHE MODEL)
Clear screen



CNC 8060
CNC 8065

(REF: 1402)

12.8 Options

This softkey is used to set the appearance and some functions of the graphic window. These options may be used at any time, even while executing a program.



When selecting this option, the softkey menu shows the available options. To return to the main menu, press the [BACK] key.

Option "Activate"

This softkey may be used to activate the graphics. The softkey appears pressed when this option is enabled. The status of this softkey cannot be modified while executing or simulating a program.

When the graphic representation is deactivated and activated, the current graphic is erased; but the display conditions are kept active (type of graphics, zoom, graphic parameters and display area) that were active before that mode was deactivated.

Option "Simple"

This softkey shows the single window for graphics. The softkey appears pressed when this option is enabled.

The single window hides the dialog and data areas on the right-hand side of the graphic window so the drawing occupies the whole graphic window.

Option "Lines"

This softkey hides the solid part of the graphics and only shows the tool paths. The softkey appears pressed when this option is enabled.

Option "Print"

This softkey may be used to print the graphics in the pre-determined printer or save it as a file (bmp format) at the CNC. When selecting the "File" option, it will be saved in the folder "C:\Cnc8070\Users\Reports\"; the file name may be selected using the "Print configuration" softkey.

When selecting this option, the CNC will show a dialog box requesting the print destination (printer or file). After selecting the destination, press [ENTER] to print it or [ESC] to cancel it.

Option "Print setup"

It is used to set the printing configuration. When selecting this option, the CNC shows a dialog box where the following may be defined:

- The title of the graphics that will appear next to it in the print.
- The name of the file where the graphics will be stored when printing out to a file.

After filling out the data, press [ENTER] to accept them or [ESC] to cancel them.

12.

12.9 Real coordinates

This softkey is used to draw the real tool path or the theoretical tool path. This option is only available in line type graphics.

This option is only available when executing the program; not when simulating it. When selecting this option (the softkey will appear pressed), the CNC draws the actual (real) tool path.

12.

12.10 Real coordinates with enlarged error

This softkey shows the real path, but enlarging the error with respect to the theoretical path. The error enlargement factor may be set after pressing the softkey.

This option is only available when executing the program; not when simulating it. When selecting this option (the softkey will appear pressed), the CNC draws the actual (real) tool path with enlarged error. Pressing this softkey also activates the one corresponding to the real path.

12.11 Simulation speed

This softkey is used to change the simulation speed.



When selecting this option, the softkey menu shows the options to set the simulation speed. To return to the main menu, press the [BACK] key.

This option is only available when simulating the program; not when executing it.

Speed "Edit"

It is used to select the new simulation speed. It is selected using the graduated ruler that indicates the active simulation speed.

Key.	Meaning.
	To move the ruler cursor.

13.1 Description of the graphic environment.

The graphic environment displays a graphic representation of the program that is being executed or simulated and take measurements on the graphics.

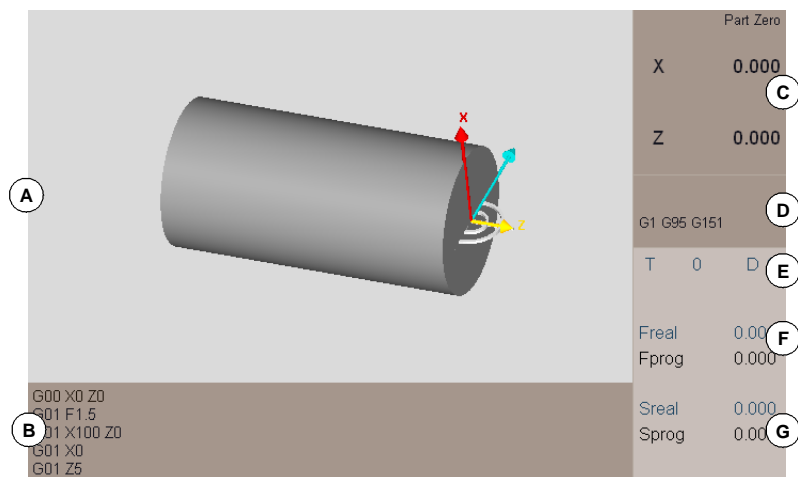

- A** Display area. Shows a graphic representation of the tool paths or of the part as the program is being executed or simulated.
- B** Blocks of the program or subroutine being executed. During execution, the cursor shows the block being executed.
- C** Current axis position referred to part zero, referred to the tool tip.
- D** Active "G" functions.
- E** Tool related information; tool number "T" and tool offset "D".
- F** Information related to the feedrate "F" of the axes:
 - "F real" Real (actual) feedrate of the axes.
 - "F prog" Programmed feedrate.
- G** Information related to the spindle speed "S".
 - "S real" Real (actual) spindle speed.
 - "S prog" Programmed speed.

13.1.1 Softkey menus.

Vertical softkey menu.







The vertical softkey menu shows the options related to the operating mode that called upon the graphic environment (EDISIMU mode for simulation, automatic mode for execution, etc.).

Horizontal softkey menu (program area).

When selecting this area, the horizontal softkey menu shows the necessary options for simulating (EDISIMU mode) or executing the program (automatic mode).

Horizontal softkey menu (graphic area).

When selecting this area, the horizontal softkey menu shows the necessary options for interacting with graphics.

Softkey.	Function.
	Select the type of view.
	Configure the graphics (number of windows, colors, etc.).
	Actions.
	Delete the graphic.
	Define the parts and the size of the graphic.
	Measure the part.
	Views. Simulation speed.

13.

HD GRAPHIC ENVIRONMENT (LATHING MODEL)
 Description of the graphic environment.



CNC 8060
CNC 8065





(REF: 1402)

13.2 Move, rotate and zoom in or out on the graphic.

When no option has been selected on the softkey menu, it is possible to act upon the graphic as follows.

Move the graphic.

To move the part of the active view, move the mouse while holding its right button or use the following keys.

Key.	Meaning.
 	Move the part to the left or to the right.
 	Move the part up or down.

Rotate the graphic.

To rotate the part of the active view, move the mouse while holding its left button or use the following keys [↑][↓][←][→].

Zoom the graphic.

To zoom in or out on the active view, turn the mouse wheel or use the [+][-] keys.

13.

HD GRAPHIC ENVIRONMENT (LATH MODEL)

Move, rotate and zoom in or out on the graphic.

FAGOR 

CNC 8060
CNC 8065

(REF: 1402)



13.3 Select the type of view.

This option is used to select the point of view of the part. Since the screen may be divided into 4 windows, the softkey only affects the active window (the one having the focus). The screen may be selected with the tab key or with the keys [1] through [4] (depending on the window to be selected).

- Top view.
- Front view.
- Left view.
- Right view.
- First user view.
- Second user view.
- Save the current view as user view.
- Select the part to be displayed.

User views.



The top view, front view and side views are predetermined views that may be moved or rotated with the mouse or with the following keys.

Key.	Meaning.
	Rotate the part.
	Move the part to the left or to the right.
	Move the part up or down.

The new position and orientation of the part may be saved as a user view. The CNC keeps the saved user views even after being turned off.

Select the part to be displayed.

The graphics may have defined up to four different parts. Each of the four windows that the screen may be divided into may display the same part or different parts. The following softkeys only affect the active window (the one having the focus).





Softkey.	Function.
	General view of all the parts.
	See the first part that the active channel is working on. When changing channels, the displayed part changes. If several channels are working on the same part, all of them can show the same part.
	View the first part. The menu shows a softkey per available part.

13.

HD GRAPHIC ENVIRONMENT (LA THE MODEL)
Select the type of view.

13.4 Configure the graphics (number of windows, colors, etc.).

This option is used to configure the graphic environment and each window.

Softkey.	Function.
	Configuration of the active window (properties of each window).
	Configuration of the sections.
	Configuration of the colors for the part and for the tool paths.
	General configuration of the graphics.
	Cancel the graphics.

Configuration of the windows (properties of each window).

This softkey is used to configure the properties of the active window so each of the four windows the screen may be divided into, may have different properties. For example, a window may show only the part to be machined and another one only the machining tool paths. The screen may be selected with the tab key or with the keys [1] through [4] (depending on the window to be selected).

Properties.	Meaning.
View part.	The graphic shows the solid part to be machined.
View tool path.	The graphic shows the machining lines.
View machine.	Not being used.
View tool colors.	The graphic shows the machining of each tool in the color defined in the color configuration.
View axes.	The graphic shows the first three axes of the channel set as origin channel for the part. These axes make up the coordinate system used to reference the part and its origin coincides with part zero.
View sections.	The graphic enables the sections, those marked as active in the configuration of the sections.
Enhance part edges.	The graphic enhances the edges of the displayed part.

Configuration of the sections.

This option is used to defined up to three planes to cut the graphic. The sections are global to all the defined parts. If there is a section defined in X100, it will cut all the parts that have that coordinate in their dimensions.

The definition of the sections is global for all the defined windows, but each window may have different sections active. To view the sections in a window, one must also enable the "view sections" option in the window properties.

Define the sections.

Each section (cutting plane) is defined using its origin point and a normal vector that defines its orientation. Both data appear on the section configuration page as "Origin" and "Normal". The color of each section may also be defined.

13.

HD GRAPHIC ENVIRONMENT (LATH MODEL)
Configure the graphics (number of windows, colors, etc.).

FAGOR 

CNC 8060
CNC 8065

(REF: 1402)

The default values define three sections, each of them perpendicular to one of the axes and cut the part in half.

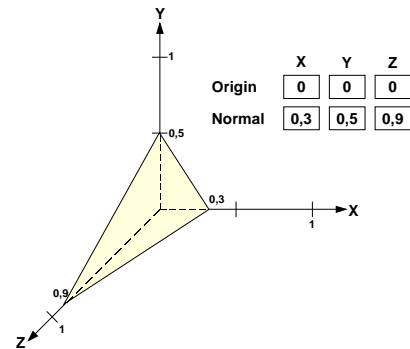
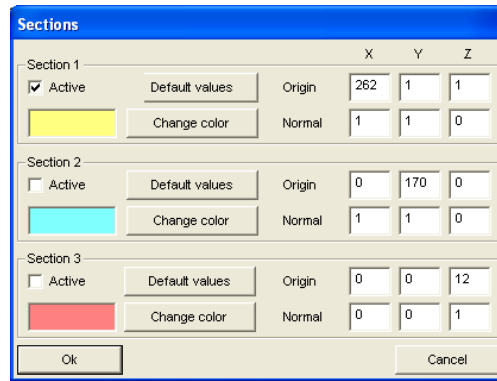

13.

HD GRAPHIC ENVIRONMENT (LA THE MODEL)
Configure the graphics (number of windows, colors, etc.).

Activate the sections.

Each section may be activated individually. The definition of active windows only affect the active window (the one having the focus).

To view the sections on the graphic, one must also enable the "view sections" option in the window properties. If the "view sections" option is not enabled, the graphic does not show any section even if they are active. If the "view sections" option is not enabled, the graphic shows the active sections separately.

Color configuration.

This softkey is used to configure the colors for the part and for the tool paths. This configuration is global for all the windows.

Path colors.

This option is used to assign colors to the following tool paths.

- Rapid traverse (G0).
- Compensated movements.
- Uncompensated movements.
- Canned cycles.
- Tapping.

Part colors.

This option is used to change the background colors, the colors of the machined areas and the look of the part. The selected values remain until the CNC is turned off.

- Background color.
- Color of the machining operations carried out with the first five tools used on the graphic. Here only the colors are defined, to display them, the "view tool colors" option must be active in the properties of the view.
- Material used to represent the solid part. The "Advanced" button may be used to change the properties of the selected material. Besides the various color components (diffuse, ambient, etc.), the brightness and transparency of the part can also be defined. Transparency may take values between 0 and 1. If the value of the transparency is other than zero, the solid part becomes transparent.

General configuration of the graphics.

This softkey may be used to configure the global properties of the graphic environment, those affecting all the windows.

Number of windows.

The graphic environment may be a full-screen window or may be divided into 2 or 4 windows, each with different properties (for example a different view of the part). The screen may be



CNC 8060
CNC 8065

(REF: 1402)

selected with the tab key or with the keys [1] through [4] (depending on the window to be selected).

Graphic parameters.

The "Advanced" button may be used to change the following parameters that affect the speed and quality of the graphic. The higher the value of these parameters, the better the graphic quality but slower drawing speed.

- Machining accuracy.
- Refresh speed.

Simulation speed.

When simulating a program (from EDISIMU mode), the simulation speed can also be defined. It is not possible during execution (automatic mode).

13.

HD GRAPHIC ENVIRONMENT (LATH MODEL)

Configure the graphics (number of windows, colors, etc.).





**CNC 8060
CNC 8065**

(REF: 1402)

13.5 Actions (move sections and print graphics).

The softkey menu may be used to carry out the following actions.

Softkey.	Function.
	Move the active sections.
	Print the graphic out to the predetermined printer or out to a file.

Move the active sections.

This option may be used to move the active sections. To move the sections, the active view must have the "view sections" option enabled and it must also have a section active. To end the possibility to move sections, press the [ESC] key or press the same softkey again. With this option active, the bottom of the screen shows a message indicating the active section and its data.

Select and move the sections.

One of the sections is always selected. To change the section to be moved, use the tab key or with the [1] [2] [3] keys (depending on the section number). The section to be moved appears in orange and the rest in the color they have been defined with.

Moving a section is actually changing its origin point which is the point in space defined by its three coordinates X Y Z. Therefore, moving a non-perpendicular section requires knowing which coordinate of the origin point is to be moved.

If the section to be moved is perpendicular to one of the axes of the trihedron, like the default sections, the [↑][→] keys move the section in the positive direction of the axis and the [↓][←] keys move it in the negative direction of the axis.

If the section is not perpendicular to any of the axes of the trihedron, it is necessary to select one of the axes of the trihedron (hold one of the keys [X] [Y] [Z] down) and use the [↑][→] keys move the section in the positive direction of the axis and the [↓][←] keys move it in the negative direction of the axis.

Print the graphic.

This option may be used to print the graphic out to the predetermined printer or out to a file.

Print the graphic.

This softkey may be used to print the graphics in the pre-determined printer or save it as a file (bmp format) at the CNC. When printing the graphic to a file, it will be saved in the folder "C:\Cnc8070\Users\Reports\"; the file name may be selected using the "Print configuration" softkey.

When selecting this option, the CNC will show a dialog box requesting the print destination (printer or file). After selecting the destination, press [ENTER] to print it or [ESC] to cancel it.

Print configuration.

This softkey may be used to set the printing properties. When selecting this option, the CNC shows a dialog box where the following may be defined:

- The title of the graphics that will appear next to it in the print.
- The name of the file where the graphics will be stored when printing out to a file.

After filling out the data, press [ENTER] to accept them or [ESC] to cancel them.



13.

13.6 Delete the graphic.

This option deletes the graphic representation; deletes the drawn tool paths and resets the solid to its initial dimensions.

13.7 Define the dimensions of the parts and the size of the graphic.

This option may be used to define the parts to be used on the graphics. The graphics may display up to four different parts at the same time and it is possible to work with all of them at the same time or with each one separately. Each of the parts may be referred to a different origin, associated with a particular channel and have different zero offsets.

Softkey.	Function.
	Edit and display the parts.
	Automatic dimensions.

Edit and display the parts.

This softkey shows the following box of options.

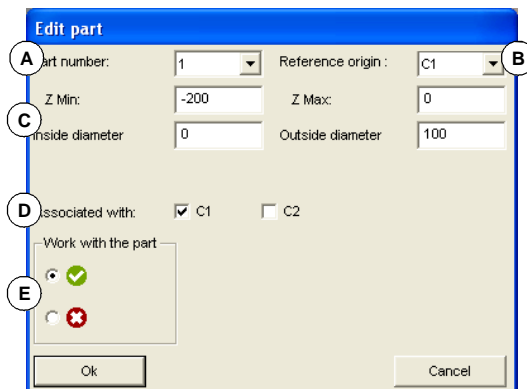

- A Part number.
- B Channel used to define the origins and the dimensions. The box will show the axes of the selected channel.
- C Part dimensions. To include a zero offset in the part, edit the zero offset at the minimum values of the axes.
- D Channels the part is associated with, to display it. Since several channels may work on a part, in order to be able to keep displaying the machining of that part when changing channels, it is necessary to define which channels are working on that part.
- E Display or hide the defined part.

Automatic dimensions.

The CNC sets the dimensions that it considers best according to the movements programmed.

13.

HD GRAPHIC ENVIRONMENT (LATH MODEL)
Delete the graphic.

13.8 Measure the part.

This option may be used to measure the distance between two points. Once measured, press the [ESC] key or press the same softkey again.

If it is a 3D view, the measuring points are always inside the a surface of the part. If it is a 2D view, the measuring points may be out of the limits of the part. Only distances external to the part may be measured in 2D views (tool path measuring).

When selecting this option, two measuring points appear on the graphic joined by a dashed line that represents the distance to measure. These measuring points are visible in all the views, but the actions are carried out in the active view.

Select and move the measuring points.

One of the measuring points is always active; to change the active measuring point, use the tab key or place the cursor on it. The CNC shows the active measuring point in a different color.

The active measuring point may be moved with the mouse or with the [↑][↓][←][→] keys. With the mouse, click on one point of the screen, the active measuring point moves to that point automatically. Also with the mouse, place the cursor on the measuring point and click the left button, drag it to the measuring point.

13.9 Simulation speed.

This option may be used to change the simulation speed, same as from the graphics configuration menu. After activating this option, the CNC shows a cursor for setting the simulation speed. To move the cursor, use the mouses or the [SHIFT][←] or [SHIFT][→] keys.

Simulation speed ————— **75** ————— +

13.

HD GRAPHIC ENVIRONMENT (LA THE MODEL)
Measure the part.



CNC 8060
CNC 8065

(REF: 1402)

The MDI mode lays over all the other work modes in such a way that when quitting the MDI mode by pressing [ESC], the CNC goes into the work mode from where the MDI mode was accessed.

The channel does not allow accessing its MDI/MDA mode if a program is being executed in the same channel, except when it is interrupted. The blocks executed while a program is interrupted alter the history of the program and these changes are maintained when resuming the execution.

14.1 Interface description.

Standard window (MDI).

This window only shows the edit line of the MDI mode. In the MDI window, it is possible to edit and execute new blocks or recover blocks saved in the block history, which may be modified before executing them.

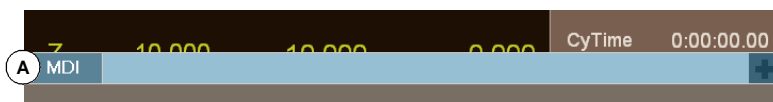

A Window for the MDI mode (Edit line) where the blocks to be executed are edited. Blocks are edited one by one.

Full screen (MDA).

This window shows the blocks saved so far and the edit line of the MDI mode. It is possible to edit and execute new blocks or recover blocks saved in the block history, which may be modified before executing them.

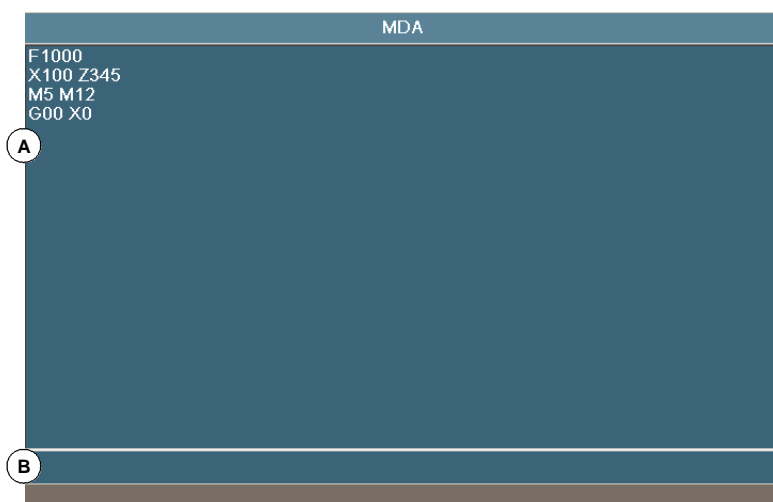

A History of blocks in MDI mode. Every time a new block is edited, it is added to this history.
 B Edit line where the blocks to be executed are edited. Blocks are edited one by one.





CNC 8060
 CNC 8065

(REF: 1402)

14.1.1 Softkey menus.

Horizontal softkey menu.

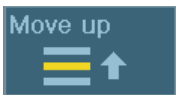
When selecting the full screen, the horizontal softkeys show the options related to this window.

Softkey.	Description.
New block.	Initiate the editing of a new block.
Modify.	Restore from the history the block selected with the cursor and insert it in the edit line. This option is the same as pressing [ENTER].
Delete.	Delete the block selected with the cursor.
Cancel edit.	Cancel the editing of the block currently being edited. This option is only available when editing a block.
Delete all.	Delete all the blocks from the block history.
Save.	Save the block history as an independent program.
	Move up the block selected with the cursor.
	Move down the block selected with the cursor.

14.

MDI/MDA MODE
Interface description.



CNC 8060
CNC 8065

(REF: 1402)

14.2 Edit and execute individual blocks.

While editing, it analyzes the syntax of the block being edited. When trying to execute, if the block is incorrect, it shows a warning message and it does not execute it.

How to edit and modify blocks.

Both in MDI and in MDA modes, it is possible to edit new blocks or restore blocks that were saved in the history. The blocks restored from the history may be modified as if they were new blocks.

Edit new blocks.

- In MDI mode, the edit line is always visible.
- In MDA mode, one must select the "new block" option from the softkey menu.

Modify a block from the block history.

- In MDI mode, use the [↑][↓] keys to pop-up the history and scroll it. The [ENTER] key restores from the history the block selected with the cursor and insert it in the edit line.
- In MDA mode, use the [↑][↓] keys, select a block from the history and use the "modify" option from the softkey menu (or the [ENTER] key to copy it into the edit line).

Block execution

The block on the edit line is executed by pressing [START] at the operator panel. Once the block has been executed is saved in the block history. The block being either in execution or interrupted, the [ESC] key may be used to hide the MDI mode without canceling the execution.

The [STOP] key interrupts the execution of the block. Press [START] again to resume execution from where it was interrupted.



Being the execution interrupted, the CNC shows the "CANCEL" softkey that may be used to cancel the execution of the block while keeping the programmed machining conditions. This softkey cancels the execution of the block without doing a general reset of the CNC. Once the block execution has been canceled, it is added to the block history.

The [RESET] key cancels the execution of the block and resets the CNC to its initial conditions.

Block execution. Changing the feedrate.

When setting a new feedrate in the MDI/MDA mode, it will become the new feedrate for the jog and automatic modes.

14.

MDI/MDA MODE

Edit and execute individual blocks.

FAGOR 

CNC 8060
CNC 8065

(REF: 1402)

14.3 Block history.

Save blocks in block history.

The MDI(MDA mode saves into history all the blocks executed correctly. Press [ENTER] to save a block in the history without executing it. If it is a new block, it will be added to the history whereas if it is modified block, it will replace the previous one in the history.

Save the blocks as a program

To save the block history as an independent program, press the "Save" softkey and the CNC will show a list of the programs saved at the CNC.

- 1 Write the program name in the bottom window. To replace an existing program, select it from the list.
- 2 Press [ENTER] to save the program or [ESC] to return to the MDI mode without saving the program.

14.**MDI/MDA MODE**
Block history.

CNC 8060
CNC 8065

(REF: 1402)

15.1 User table presentation.

The user tables cover the following tables. The various tables may be selected using the horizontal softkeys.









- Zero offset table. There is a table for each channel.
- Clamp tables (fixtures). There is a table for each channel.
- Table of global parameters. There is a table for each channel.
- Table of local parameters. There are seven tables for each channel, one table per nesting level (7 levels).
- Table of common parameters. The table is common to all the channels.

Some tables are common to all the channels and others belong to each channel. In this case, by default, they show the ones of the active channel; but it is possible to access those of any other channel from the vertical softkey menu.

The zero offset tables and fixture offset tables are common to all the channels; however, in each channel they show the axes of that channel. When applying an offset in a channel, it is only applied to the axes that are part of the channel at the time. In order to activate a fixture zero or part zero offset, those values must be previously stored in the relevant CNC table.

15.1.1 Softkey menus.

Vertical softkey menu.

Softkey.	Description.
	Show more options on the softkey menu.
	<p>Toggle the units for the position of the linear axes. Toggling these units does not affect the rotary axes which will always be displayed in degrees. The softkey highlights the units currently selected (millimeters or inches).</p> <p>The selected units are only valid for displaying data. For programming, the CNC assumes the units defined with the active function G70 or G71, or, when not programmed, the units set by the machine manufacturer (INCHES parameter).</p> <p>The CNC will display this softkey or not depending on how machine parameter MMINCHSOFTKEY has been set.</p>
	Initialize the table. Reset all the table data to "0". The CNC will request confirmation of the command.
	Search a text or a value in the table. When selecting this option, the CNC shows a dialog box requesting the text to be found.
	Accessing the tables of other channels. With some tables, only the data of the active channel are displayed, this softkey is used to show the tables of the other channels. This softkey will only be available when using channels.
	Select the axes to be displayed in the tables. When using several channels, only those axes assigned to the active channel may be accessed.
	Save the values of the table into a file.
	Restore the values of the table previously saved into a file.
	Print the table in the pre-determined printer or save it as a file (prn format) at the CNC.

15.

USER TABLES
User table presentation.



CNC 8060
CNC 8065

(REF: 1402)

15.2 Zero offset tables

This table contains the absolute zero offsets (G54 to G59 and G159) and the PLC offset of the axes and spindles that may be activated as C axis. The table highlights in color the active offset, both absolute and incremental.

The zero offset may have two different looks, with or without fine setting of absolute zero offset. The type of table depends on the configuration set by the OEM (parameter FINEORG).

The table shows the axes and spindles that are in the channel at the time; in other words, after swapping axes or spindles between channels, the CNC updates the table. The zero offsets associated with the possible C axes are always visible, even when the C axis is not active.



When accessed from the a channel, the table only shows the axes and spindles of that channel. The vertical softkey menu may be used to access the zero offsets of the rest of the channels.

PLC offset (PLC offset).

The PLC offset may not be set directly in the table, its values are set from the PLC or via part-program using variables. This offset is used, for example, to correct deviations originated by machine dilatations. The CNC always adds the PLC offset to the selected zero offset.

Incremental zero offsets.

This zero offset may not be set directly in the table, its values are set via part-program or via variables. The CNC adds the incremental zero offset to the absolute zero offset active at the time.

Absolute zero offsets

Absolute zero offsets besides being set directly in the table may also be set from the PLC or via part-program using variables.

The zero offsets are used to place the part zero at different positions of the machine. When applying a zero offset, the CNC assumes as the new part zero the point set by the selected zero offset referred to the clamp zero (if active) or to the machine zero (if the clamp zero is not active). To apply an absolute zero offset, it must be activated via program using the relevant function.

15.

USER TABLES
Zero offset tables

FAGOR 

CNC 8060
CNC 8065

(REF: 1402)

Absolute zero offset table (with fine setting of the zero offset).

Each zero offset has a single value. When activating a zero offset (function G159), the CNC assumes this value as the new zero offset.

Channel 1 : Zero offsets			
Origin	X (mm)	A Y (mm)	Z (mm)
PLCOF	00000.0000	00000.0000	00000.0000
G158	00054.5000	00010.0000	00000.0000
G54 (G159=1)	00000.0000	00000.0000	00000.0000
G55 (G159=2)	00000.0000	00000.0000	00000.0000
B G56 (G159=3)	00000.0000	00000.0000	00000.0000
G57 (G159=4)	00000.0000	00000.0000	00000.0000
G58 (G159=5)	00000.0000	C 00000.0000	00000.0000
G59 (G159=6)	00000.0000	00000.0000	00000.0000
G159=7	00000.0000	00000.0000	00000.0000
G159=8	00000.0000	00000.0000	00000.0000
G159=9	00000.0000	00000.0000	00000.0000
G159=10	00000.0000	00000.0000	00000.0000
G159=11	00000.0000	00000.0000	00000.0000
G159=12	00000.0000	00000.0000	00000.0000

- A Machine axes and display units (millimeters, inches or degrees).
- B Zero offsets.
- C Zero offset value in each axes of the channel.

Absolute zero offset table (with fine setting of the zero offset).

Each zero offset has a coarse (or absolute) value and a fine (or incremental) value. Setting the coarse value of an offset deletes its fine value. When activating an offset (function G159), the CNC assumes as new zero offset the sum of both parts.

Channel 1 : Zero offsets			
Origin	X (mm)	A Y (mm)	Z (mm)
PLCOF	00000.0000	00000.0000	00000.0000
G158	00054.5000	00010.0000	00000.0000
G54 (G159=1)	00050.0000	00000.0000	00000.0000
△	00003.0000	00000.0000	00000.0000
B G55 (G159=2)	00000.0000	00000.0000	00000.0000
C △	00000.0000	00000.0000	00000.0000
G56 (G159=3)	00010.0000	00000.0000	00000.0000
△	00000.0000	00000.0000	00000.0000
G57 (G159=4)	00000.0000	D 00000.0000	00000.0000
△	00000.0000	00000.0000	00000.0000
G58 (G159=5)	00000.0000	00000.0000	00000.0000
△	00000.0000	00000.0000	00000.0000
G59 (G159=6)	00000.0000	00000.0000	00000.0000
△	00000.0000	00000.0000	00000.0000

- A Machine axes and display units (millimeters, inches or degrees).
- B Zero offsets (coarse part).
- C Zero offsets (fine part).
- D Zero offset value in each axes of the channel.

15.
USER TABLES
 Zero offset tables



CNC 8060
 CNC 8065

(REF: 1402)

15.3 Fixture table

This table stores the clamp offsets for each axis. There are up to 10 clamp offsets. The table highlights in color the active zero offset.



When accessed from the a channel, the table only shows the axes of that channel. The vertical softkey menu may be used to access the zero offsets of the rest of the channels.

Channel 1 : Fixture offsets			
Fixture	X (mm)	Y (A)	Z (mm)
1	00000.0000	00000.0000	00000.0000
2	00000.0000	00000.0000	00000.0000
3	00000.0000	00000.0000	00000.0000
4	00000.0000	00000.0000	00000.0000
(B)	00000.0000	00000.0000	00000.0000
6	00000.0000	00000.0000	00000.0000
7	00000.0000	00000.0000	00000.0000
8	00000.0000	0(C).0000	00000.0000
9	00000.0000	00000.0000	00000.0000
10	00000.0000	00000.0000	00000.0000

A Machine axes and display units (millimeters, inches or degrees).

B Clamp offset.

C Clamp offset value in each axes of the channel.

The end of this chapter describes how to edit this table.

Fixture offset

The fixture offset besides being set directly in the table may also be set from the PLC or via part-program using variables.

The clamp offsets are used to set the position of the clamping system of the machine. When applying a clamp offset, the CNC assumes as new clamp zero the point set by the selected offset referred to machine reference zero (home). To apply a clamp offset it must be activated from the program using the relevant variable.

15.

USER TABLES
Fixture table



CNC 8060
CNC 8065

(REF: 1402)

15.4 Arithmetic parameter tables

There are the following arithmetic parameter tables:

- Common parameters. The table is common to all the channels.
- Global parameters. There is a table for each channel.
- Local parameters. There are seven tables for each channel, one table per nesting level (7 levels).

The CNC generates a new nesting level for local parameters every time parameters are assigned to a subroutine. The end of this chapter describes how to edit these tables.

Parameter	Value	Comment
P10000	101.965800	Comments
P10001	0	Comments
P10002	100	Comments
P10003	23	Comments
P10004	1	Comments
P10005	0.12345678	Comments
P10006	1.002380	Comments
P10007	-5813	Comments
P10008	-12.025800	Comments
P10009	0	Comments
P10010	0	Comments
P10011	0	Comments
P10012	0	Comments
P10013	0	Comments

- A Parameter list.
- B Parameter value.
- C Parameter describing comment (only in the common-parameters table).

This field offers the possibility to associate a short description with the M function. This field is for information only; it is not used by the CNC. The comments are saved in the file UCPCComments.txt and it is possible to have one file per language. These files are saved in the folder "../MTB /data /Lang".

Arithmetic parameters

The OEM defines the range of local and global parameters up to a maximum of 100 local parameters (P0-P99) and 9900 global parameters (P100-P9999).

When the local parameters are used in a subroutine calling block, they can also be referred to by the letters A-Z (except "N") in such a way that "A" is the same as P0 and "Z" is the same as P25. That is why the local parameter tables show the parameter number next to their associated letter.

The parameter values may be set directly in the table or from the PLC or via part-program. In this case, the table values are updated after carrying out the operations indicated in the block being executed.

The parameter values may be displayed either in decimal notation (6475.873) or scientific (0.654E-3).











15.

15.5 Operations with tables

15.5.1 Data editing

Select the desired table using the horizontal softkey menu. To edit the table data, proceed as follows:

- 1 Use the cursor to select the cell whose value is to be changed.
- 2 Key in the new value.
- 3 Press [ENTER] to accept the new value or [ESC] to ignore the new value and recover the previous one.

Key.	Meaning.
   	Move the cursor.
 	Move the cursor page by page.
 	Move the cursor to the beginning / end of the table.
	Accept the value.
	Reject the value.

How to use the calculator to set the data (table of zero offsets and clamp offsets).

Being the focus on any field of the zero offset table or clamp offset table, press [INS] or [CTRL][K] to access the calculator. The calculator takes the current value of the field and may be used to perform any operation. Press [INS] to load calculated value into the field and close the calculator.

Pressing [ENTER] instead of [INS] calculates the value without inserting it into the field and it allows going on with other operations.

15.5.2 Save and recall tables

Save a table.



This softkey is used to save the table data, in ASCII format, in a file. After selecting the table whose data is to be saved, press the "Save" softkey and the CNC shows a list with the tables that are already saved. To save the table data, proceed as follows:

- 1 Select the destination folder.
- 2 Define the file name at the bottom window. To replace an existing file, select it from the list.
- 3 Press [ENTER] to save the file or [ESC] to return to the table without saving the file.

Depending on the table being saved, the CNC will assign one of the following extensions to the file:

Extension.	Table type
*.UPO	Zero offset table.
*.UPF	Fixture table.
*.UPP	Arithmetic parameter tables.

Recall a table.



This softkey is used to restore the table data from an ASCII file. After selecting the table whose data is to be restored, press the "Load" softkey and the CNC shows a list with the tables that are already saved. To recover the table data, proceed as follows:

- 1 Select the folder containing the file.
- 2 Select the file from the list or write its name in the bottom window.
- 3 Press [ENTER] to recall the data from the file or [ESC] to return to the table without recalling the data.

15.

USER TABLES
Operations with tables



CNC 8060
CNC 8065

(REF: 1402)

15.5.3 Find text.



This softkey is used to find text or a value in the table. After pressing this softkey, the CNC shows a dialog box requesting the text or value to be found. It is also possible to select whether the search must start at the beginning of the table or at the current cursor position.

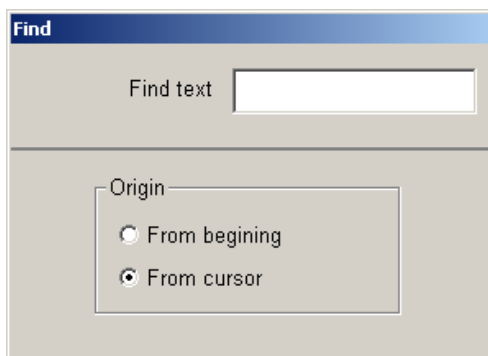

Key.	Meaning.
	Move the cursor.
	It selects an option from a group.
	Start the search.
	Cancel the search and close the dialog box.



After defining the search options, press [ENTER] to do the search or [ESC] to cancel it. Pressing [ENTER] positions the cursor in the first field that matches the search parameters. Pressing this FIND icon again will allow repeating the search or defining a new one.

15.

USER TABLES
Operations with tables

15.

USER TABLES

Operations with tables



CNC 8060
CNC 8065

(REF: 1402)

16.1 Presentation of the tool tables and magazine tables.







This operating mode consists of several tables. The various tables may be selected using the horizontal softkeys. If while one of the tables is selected, the [BACK] key is pressed, that table will be deselected.

- Tool table.
- Active-tools table.
- Table for the status of the tool change process.
- Tool magazine tables.

In order to load a tool in the magazine or in the spindle, that tool must have been previously defined in the corresponding table of the CNC.

16.1.1 Softkey menus.

Horizontal softkey menu.

Softkey	Table
	<p>Tool table.</p> <p>This table defines the tools available and the data associated with each one of them. This table is common to all the magazines.</p>
	<p>Active-tools table.</p> <p>This table shows the tool that is active in each channel and the data associated with it.</p>
	<p>Change process.</p> <p>This table monitors the tool changes being executed in each channel.</p>
 	<p>Tool magazine table (there is one table per magazine)</p> <p>For each magazine, it shows the tool distribution and the remaining life time of each tool (if tool life monitoring is active). If the magazine has a changer arm, it shows the tool located in it. The description of the magazine type can also be shown.</p> <p>The icon associated with this table depends on the software configuration (lathe or mill).</p>

When selecting one of these tables, it is displayed on the screen and the vertical icon menu shows the icons associated with that table. Later sections of this chapter show a more detailed description of the icons and operations that may be carried out in each table.

Vertical softkey menu.

If no table is currently selected, the vertical softkey menu will show the following softkeys to save or load all the tables. See "[16.1.3 Save and load the tables](#)" on page 242.



Save the tables

Saves the data of all the tables.



Recall the tables

It restores the data previously saved for all the tables.

16.1.2 Search for a text in the tables

It is possible to search for a text or a value in the list of tools and magazine positions. The search is carried out from the vertical softkey menu.



This icon starts the search. Once the icon has been pressed, the CNC will display a dialog box to define the search criteria. The defined criteria is maintained until a new one is defined.



This icon is shown when a search criteria has been defined; it makes it possible to search for the next match using the current search criteria.

To start or resume the search, press [ENTER] and the focus will position on the first match found. Every time one of the icons is pressed, it offers the option to search for the next match or to define a new search. The search may be canceled by pressing the [ESC] key.

Define the search criteria.

Every time one of these icons is pressed, it shows a dialog box to define the search criteria. The following may be defined in this dialog box:

- The text or value to search for.
- The beginning point of the search, namely either from the beginning of the table or from the cursor position.

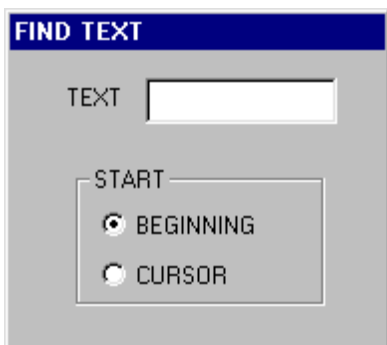

Key.	Meaning.
	Move the cursor.
	It selects an option from a group.
	Start the search.
	Cancel the search and close the dialog box.

16.1.3 Save and load the tables

From the vertical softkey menu, it is possible to make a backup copy of the table data (recommended). With these files, it is possible to recover the table data when needed.

These tables are saved in the an ASCII file. These files may be saved at the CNC, in a floppy disk or at another device (CNC, PC, etc.) connected through Ethernet. By default, they are saved in the folder "C:\CNC8070\MTB\DATA" or in the last folder selected by the user.

These tables are saved in the following files. The table monitoring the change processes is informative only; it is not copied anywhere.

Table	File
Tool table.	Tools.TPT
Active-tools table.	Toolsact.TPA
Tool magazine table (if there is only one magazine).	Magazine.TPM
Tool magazine table (if there are several magazines).	Magazine1.TPM ... Magazine4.TPM

Considerations for saving and loading tables.

Although each table may be saved separately, it is recommended to always have a copy of all the tables. Also, the following must be borne in mind when loading the tables:

- Loading the tool table initializes the magazine tables and the active-tools table. When changing the list of available tools, it may not be coherent with the tool distribution in the magazine or in the spindles. This is why after loading this table it is necessary to define (or load) the magazine tables and the active-tools table, if any, in that order.
- Loading the magazine table initializes the active-tools table. This is because when loading the magazine tables, the new tool arrangement may not be coherent with the active tools. This is why after loading this table, it is necessary to load the active-tools table.

Save the tables

The tables may be saved one by one or all of them simultaneously. In either case, the action is carried out from the vertical softkey menu using one of the following icons.



Saving all the tables at the same time. To save all the tables at the same time, no table must be selected.



Saving each table separately. To save the tables one by one, select each table from the horizontal softkey menu.

After pressing the icon, the CNC will ask where to save the data files. Select the desired folder and press [ENTER]. The selection process may be canceled by pressing the [ESC] key.

Recall the tables

It may be used to restore the data, in ASCII format, of the tables from the files. The tables may be loaded one by one or all of them simultaneously. In either case, the action is carried out from the vertical softkey menu using one of the following icons.



Loading all the tables at the same time. To load all the tables at the same time, no table must be selected.



Loading each table separately. To load the tables one by one, select each table from the horizontal softkey menu. To load the data of all the tables (recommended), follow a particular loading order to guarantee data consistency.

After pressing the icon, the CNC will ask the location of the data files. Select the desired folder and press [ENTER]. The selection process may be canceled by pressing the [ESC] key.

16.

Order (sequence) to follow when loading the different tables.

As mentioned earlier, there are two ways to load the table data from the ASCII files; loading all of them at the same time or selecting each table and loading its data.

Loading all the tables at the same time.

In this case, it is up to the CNC to set the order (sequence) used to load the data.

Order (sequence) to follow when loading the tables one by one.

This way, each table is selected and its data loaded. In this case, the following sequence must be followed when loading the tables.

1 First load the tool table.

This table defines the system tools. Loading the tool table initializes the tables of the magazines and the active-tools table.

2 Second, load the tool magazine tables.

Since the tool list has changed, if the magazine tables are not loaded, it is not possible to assure that the new tools are the ones located in the magazine tool or in the active-tools table.

3 Finally, load the active-tools table.

When loading the tables of magazines, it is unsure that the current tool positions will be compatible with the active tools.

16.

TOOL AND MAGAZINE TABLE

Presentation of the tool tables and magazine tables.



CNC 8060
CNC 8065

(REF: 1402)

16.1.4 Printing the tables

Some of the tables may be printed in a printer accessible from the CNC or as a file (PRN format). When the tables are saved as a file, it may be saved at the CNC, in a floppy disk or at any other device (CNC, PC, etc.) connected through Ethernet. By default, the files are saved in the folder "C:\CNC8070\USERS\Reports".

In either case, the action is carried out from the vertical softkey menu.



This softkey starts printing. When pressing this icon, the CNC will show a dialog box requesting the print destination for the table (printer or file).

After selecting the target, press [ENTER] to start printing. Press [ESC] to cancel the selection.

16.

TOOL AND MAGAZINE TABLE
Presentation of the tool tables and magazine tables.





CNC 8060
CNC 8065

(REF: 1402)

16.2 Tool table

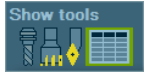
The CNC offers two tool tables. Use the following softkeys to select each one of them.



Softkey	Table
	Softkey available when the tool table is selected in simple mode, it toggles to full mode.
	Softkey available when the tool table is selected in full mode, it toggles to simple mode.

Tool table (full mode)

The table is divided in two panels. The left panel shows the list of the available tools and the right panel shows the data of the tool selected on the list.

This table may be used to set all the tool data. It is also possible to add or remove tools and offsets from the table.













Tools			Tool 8			
Tool	Name	Position	Number	Name	Offsets	Status
1		1	8		1	Available
2		2	0			
3		3				
4		C1				
5		5				
6		6				
7		7				
8		8				
9		9				
10		10				
11		11				
12		12				
13		13				
14		14				
15		15				
16		16				

Edge Geometry (mm) + Monitoring			
Type	Drill bit	L	R
Drilling		0	0
Drill bit		0	0
LW		0	0
RW		0	0
Rp		0.2	0
Lc		6	
Ae		0	
Off. X		0	0
Off. Y		0	0
Off. Z		0	0
Off. U		0	0

Length

Tool table (simple mode)

The table shows the list of tools with most common data. This table can only be used to set some tool data. Unlike the full mode, the simple mode does not allow adding or removing tools or offsets from the table.

M TOOLS: STANDARD									
T	D	Mz	Name	L	L W	R	R W	Rp	Rp W
1	1	1		75.0000	0.0000	25.0000	0.0000	0.0000	0.0000
2	1	1		100.0000	0.0000	7.5000	0.0000	0.0000	0.0000
3	1	1		75.0000	0.0000	5.0000	0.0000	1.0000	0.0000
4	1	1		70.0000	0.0000	4.0000	0.0000	0.0000	0.0000
5	1	1		85.0000	0.0000	2.5000	0.0000	0.0000	0.0000
6	1	1		85.0000	0.0000	2.5000	0.0000	0.0000	0.0000
7	1	1		80.0000	0.0000	5.0000	0.0000	5.0000	0.0000
8	1	1		65.0000	0.0000	3.0000	0.0000	0.0000	0.0000
9	1	1		100.0000	0.0000	10.0000	0.0000	0.4000	0.0000
10	1	1		85.0000	0.0000	7.5000	0.0000	0.0000	0.0000
11	1	1		65.0000	0.0000	5.0000	0.0000	0.0000	0.0000
12	1	1		125.0000	0.0000	12.0000	0.0000	0.0000	0.0000
13	1	1		135.0000	0.0000	25.0000	0.0000	0.0000	0.0000

Radius

16.

TOOL AND MAGAZINE TABLE
Tool table



CNC 8060
CNC 8065

(REF: 1402)

About the tools

Each tool is identified by its number, that is unique for the whole system; it cannot be repeated in different magazines nor in ground tools. This table indicates the position and the magazine where each tool is located, whether it is a ground tool or the tool is active in a channel.

Ground tools

A ground tool is a tool that is not stored in any magazine and is loaded manually when requested. Ground tools are also defined in the tool table, but they are not associated with any magazine position.

Ground tool loading and unloading is global to the system; it is not associated with any particular magazine or channel.

16.**TOOL AND MAGAZINE TABLE**
Tool table

CNC 8060
CNC 8065



(REF: 1402)

16.3 Tool and tool magazine table.

This table defines the tools available and the data associated with each one of them. The tool list is common to the whole system, i.e. is common to all the available magazines. Once the tools have been defined, they may be distributed in the various magazines.

16.3.1 Vertical softkey menu.

The options shown for the tool table are. Bear in mind that the table is divided into two panels. There are options that are valid for both panels and options that are only available on one of them.

Softkey.	Description.
	Show more options on the softkey menu.
	Change the units for data display. The softkey highlights the units currently selected (millimeters or inches). The selected units are only valid for displaying data. For programming, the CNC assumes the units defined with the active function G70 or G71, or, when not programmed, the units set by the machine manufacturer (INCHES parameter). The CNC will display this softkey or not depending on how machine parameter MMINCHSOFTKEY has been set.
	Search for a text on a tool list. See " 16.1.2 Search for a text in the tables " on page 241.
	Add a new tool to the list. This icon is only available for the tool list.
	Remove a tool from the list. A tool cannot be deleted if it is in the tool magazine. This icon is only available for the tool list.
	Delete the data where the cursor is. When deleting a data, it assumes its default value. This icon is only available for tool data.
	Configure the data shown in the tool table. This icon is only available for tool data.
	It initializes the tool table. Initializing the tables eliminates all the tools from the list. It also initializes the active-tools table and the magazine tables because the available tools have been erased. The CNC will request confirmation of the command.
	Saves the table data in a file. See " 16.1.3 Save and load the tables " on page 242.
	Recall the table data previously saved in a file. Bear in mind that loading the tool table initializes the magazine tables and the active-tools table. See " 16.1.3 Save and load the tables " on page 242.
	Print the table in the pre-determined printer or save it as a file (prn format) at the CNC. See " 16.1.4 Printing the tables " on page 244.



16.

TOOL AND MAGAZINE TABLE
Tool and tool magazine table.



CNC 8060
CNC 8065

(REF: 1402)

Softkey.	Description.
	Copy the data of the offset being displayed onto the clipboard. The data saved may be pasted to a new offset.
	Paste the offset data that is saved on the clipboard.

16.

TOOL AND MAGAZINE TABLE
Tool and tool magazine table.

16.3.2 The tool list

The tool list appears on the left panel of the tool table. The list shows the available tools and their position. The CNC updates data of the list every time a tool change is carried out.

Tool number

The tool number is assigned automatically when adding the tool to the list and may be modified by the user in the data window.

Tool name

Name identifying the tool defined by the user in the data window. It may be edited directly on the list.





Tool position

It indicates the position of the tool, in a magazine, in the spindle or in the claws of the tool changer arm.

- C1-C4 It is in one of the spindles.
- M1-M4 It is in one of the magazines. In this case, it also indicates its magazine position.
- CH1-CH2 It is in the holders of the tool changer arm.

If none of these positions is indicated, it means that it is a ground tool. Ground tools are not stored in the magazine and are loaded manually when requested.

How to move around on the tool list

Key.	Meaning.
	Scroll list up and down line by line.
	Move the cursor page by page through the list.
	Move the cursor to the beginning or end of the list.
	Access the data of the selected tool.



CNC 8060
CNC 8065

(REF: 1402)

16.3.3 Description of the tool data

The right panel of the tool table shows the data of the tool selected on the list. This data must be defined by the user. If the CNC has tool life monitoring, the CNC will be in charge of updating the value of the actual (real) life.

Configuring the tool data display

The data being shown in the tool table may be set up from the vertical softkey menu.



Softkey to access the setup panel of the tool table. When pressing this softkey, the CNC shows a dialog box to carry out the following actions.

- Select the data to be shown in the tool table. To show or hide a data, activate or cancel its check box.
- Assign a name or text to any of the 4 "custom" parameters available in each tool.
- Define whether the wear is entered either with an incremental or with an absolute value.

Key.	Meaning.
	Move the cursor.
	Activate/deactivate the selection box.
	Accept the configuration defined.
	Cancel the defined configuration.

Description of the tool data

The tool data is grouped as follows:

- Tool identification.
- Tool geometry.
- Tool monitoring.
- Information for the magazine.
- Custom.
- Comment.

Tool identification

Information identifying the tool: number, name, family, number of tool offsets and status.

Tool number

The tool number is assigned automatically when the tool is added to the list. This number may be changed if it is not in the magazine, in the spindle or on the tool changer arm.

The tool number may be any integer between 1 and 999999999; by default, it is assigned the first available value on the list. When entering an existing tool number, the CNC displays the data for that tool.

Tool name

Name identifying the tool. This data can also be defined on the tool list. The tool name may be up to 32-characters long.

Tool family

A tool family is a group of tools that share similar characteristics. This information is used when using an automatic tool changer so the CNC can replace the worn-out or rejected tool with a similar one.

When requesting a new tool, the CNC checks whether it is worn out (real life greater than nominal life) or it has been rejected. If so, it selects the next tool in the table that belongs to the same family.

The family or a tool may be any integer between 0 and 99999999. The ·0· family is the same as not having a family; i.e. the tools belonging to the ·0· family cannot be replaced with another one.

Tool offsets

Number of tool offsets. Each tool offset has different geometry and monitory data associated with it.

A tool can have up to 8 offsets. When a tool has several offsets, their numbers must be correlative (non-skipping).

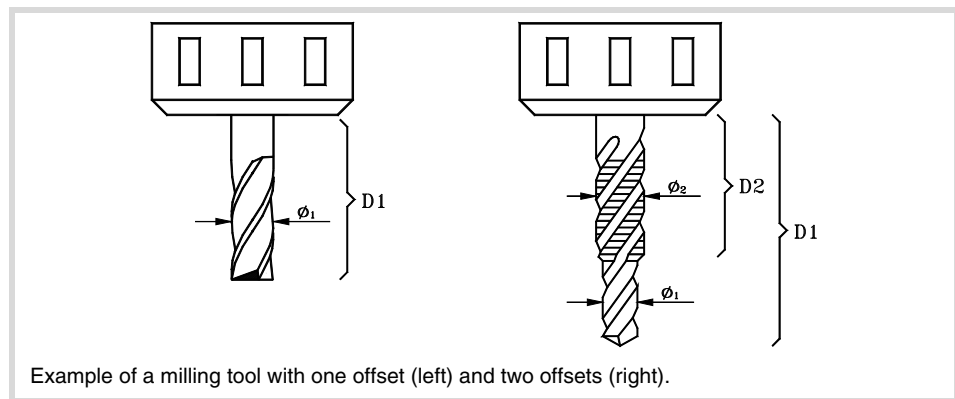

Tool status

It indicates the tool status. The possible status are:

Status	Meaning
Available	The tool is available.
Worn out	The "real life" is greater than the "nominal life".
Rejected	The tool has been rejected by the PLC.

When using tool life monitoring, the "worn-out" and "rejected" indicators are also set by the CNC when any of the previous cases occur.

Tool geometry

This area shows the data about the tool type and its dimensions. The geometry data depends on the type of tool. The table only shows the data that makes sense for the selected tool.

While defining the data, it shows various information graphics depending on the data being defined. On the other hand, the bottom of the screen shows the description of the data currently selected.

The data related to the geometry may be accessed with the following hotkeys:

Hotkey	Access
L	Length, length wear and edge length.
R	Radius, radius wear, nose (tip) radius and nose (tip) radius wear.
A	Penetration angle
O	Offsets on each axis.

Offset selection

The geometry data is associated with the tool offset. If the tool has been defined with several offsets, it shows the number of the offset whose data is displayed, and it also allows selecting

16.

TOOL AND MAGAZINE TABLE
Tool and tool magazine table.



CNC 8060
CNC 8065

(REF: 1402)

the previous or next offset. To change offsets, place the focus on the buttons and press [SPACE].

















Offset number and selection of the previous or next offset. In this case, it will display the data of the second tool offset.

Operation type and tool

Regardless of the software installed, it is possible to define both milling and lathe tools. The tool is defined depending on the operation it can carry out. If it is not the right tool for any of the proposed operations, it must be assigned the operation "Others".

Once the operation has been selected, the screen will show the available tools. It will show a help graphic with the selected tool type.

The data to define the geometry of the tool will be relevant to the selected tool. It will only show the data that makes sense for the selected tool.

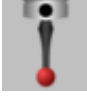
Operation	Tool type
Milling (A) Flat endmill. (B) Toric endmill. (C) Ball endmill. (D) Disk endmill.	 (A)  (B)  (C)  (D)
Reaming (A) Reamer.	 (A)
Grooving/cutoff (A) Square.	 (A)
Drilling (A) Drill bit.	 (A)
Boring (A) Quill.	 (A)
Turning (A) Diamond. (B) Square. (C) Round.	 (A)  (B)  (C)
Surface milling (A) Surface milling endmill.	 (A)
Tapping (A) Cutter. (B) Tap.	 (A)  (B)
Measuring probe	
Others	To define the tools that do are not suitable for the proposed operations.

Axis orientation in turning.

It is defined with an icon that is only displayed when defining a turning (lathe) tool.

The orientation of the axes is determined by the type of lathe (horizontal or vertical), the position of the turret and the spindle position (on the right or on the left).

Location code or tool calibration point.

It is defined with an icon that is only displayed when defining a turning (lathe) tool.





The location code indicates which is the calibrated tool tip and, therefore, the point controlled by the CNC to apply radius compensation. The location code depends on the orientation of the machine axes.

Tool-holder orientation.

It is defined by an icon that is displayed in the following cases.



- On a lathe model, for all the tools.
- On a mill model, only for turning (lathe) tools.

The orientation of the tool holder indicates whether it is a tool for horizontal or radial machining. For turning tools, the meaning of this icon depends on the orientation of the tool axes.

		Horizontal lathe. Radial machining.
		Vertical lathe. Longitudinal machining.

Spindle turning direction

Use the following icons to define the spindle turning direction.

Icon	Spindle turning direction
	Undefined spindle turning direction.
	Clockwise spindle turning direction.
	Counterclockwise spindle turning direction.

The new tools do not have a pre-determined spindle turning direction; during execution, the spindle turns in the programmed direction (M03/M04).

When assigning a turning direction to a tool in the table, the CNC will verify, during execution, that the turning direction in the table is the same as the one programmed (M03/M04). If the two directions are not the same, the CNC will display the corresponding error message. The CNC verifies this every time an M03, M04 or M06 is programmed.

"L" - Tool length

This data is only shown on tools that are not for turning. The dimensions of the turning tools are defined with the offsets.

"R" - Tool radius

This data is only shown on tools that are not for turning. The dimensions of the turning tools are defined with the offsets.

	L	Tool length.
	R	Tool radius.
	Lc	Cutting length.

16.

TOOL AND MAGAZINE TABLE
Tool and tool magazine table.



CNC 8060
CNC 8065

(REF: 1402)

"LW" "RW" - Tool length and radius wear

Tool radius wear and length wear offset. The CNC adds the wear value to the nominal length and radius to calculate the real tool length ($L + LW$) and real tool radius ($R + RW$).

Initial length	Wear	Final length
50	0.2	50.2
50	-0.2	49.8
-50	0.2	-49.8
-50	-0.2	-50.2

In the tool table, it is possible to define whether the wear value being entered must be incremental or absolute. In either case, deleting the wear value or setting it to 0 implies resetting the amount of wear to 0. See *"Select the type of wear values to enter, incremental or absolute."* on page 255.

Using incremental wear, the value entered by the user will be added (or subtracted if it is negative) to the absolute value of the wear. After pressing [ENTER] to accept the new value, the wear field will show the resulting absolute value.

Initial wear	Incremental wear	Total wear
1	0.2	1.2
1	-0.2	0.8
-1	0.2	-0.8
-1	-0.2	-1.2

"A" - Cutter angle

This data is only shown for turning tools. For the grooving and cut-off tool, this data assumes a value of 90°.

"C" - Cutting angle

This data is only shown for turning tools. For the grooving and cut-off tool, this data assumes a value of 90°.

"B" - Cutter width

This data is only shown for turning tools.

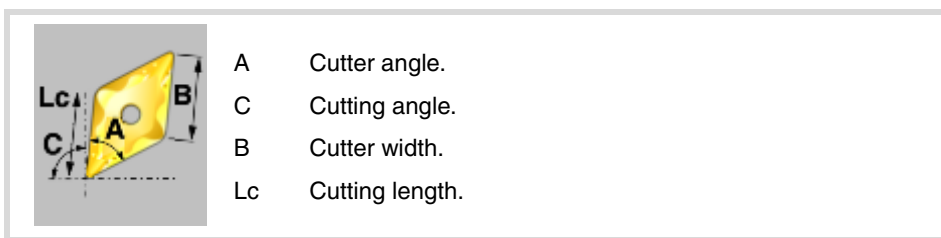

"Rp" - Tool tip radius

Tool tip radius. For the grooving and cut-off tool, this data assumes a value of 0.

"RpW" - Tool tip radius wear

Tool tip radius wear. The CNC adds the wear value to the nominal tool tip radius to calculate the actual (real) tool tip radius ($Rp + RpW$).

In the tool table, it is possible to define whether the wear value being entered must be incremental or absolute. In either case, deleting the wear value or setting it to 0 implies resetting the amount of wear to 0. See *"Select the type of wear values to enter, incremental or absolute."* on page 255.

Using incremental wear, the value entered by the user will be added (or subtracted if it is negative) to the absolute value of the wear. After pressing [ENTER] to accept the new value, the wear field will show the resulting absolute value.

"Lc" - Cutting length

Length of the cutting edge.

"Ae" - Entry angle

This data is only shown on tools that are not for turning. Penetration angle for pocket milling.

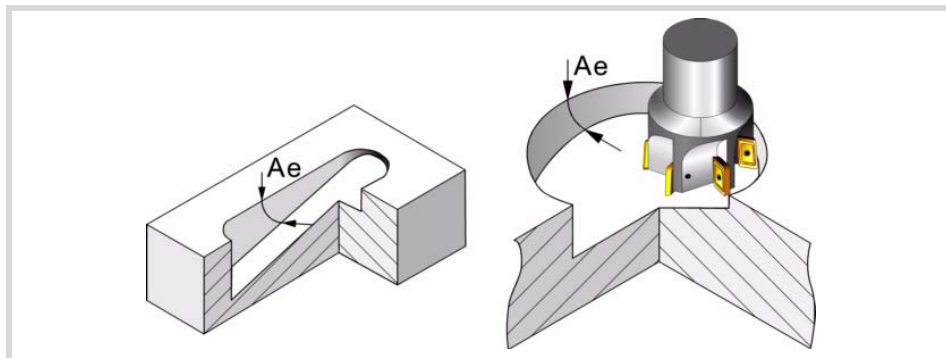

Tool (length) offsets and offset wear.

The offsets are used to define the tool dimensions in each axis. The dimensions of the turning tools are defined using these offsets; either these offsets or tool length and radius may be used for the dimensions of the rest of the tools.

On tools that are not just for turning, e.g. endmills and drill bits, the offsets may also be used to define the tool position when using a tool holder or an intermediate tool. In this case, the tool dimensions are defined with the radius and the length.

The sign criterion for the offsets and their wear is established by machine parameter TOOLOFSG.

TOOLOFSG	Meaning.
Negative. 	Tool calibration returns a negative offset. The offset wear must be entered with a positive value.
Positive. 	Tool calibration returns a positive offset. The offset wear must be entered with a negative value.

In the tool table, it is possible to define whether the wear value being entered must be incremental or absolute. In either case, deleting the wear value or setting it to 0 implies resetting the amount of wear to 0. See ["Select the type of wear values to enter, incremental or absolute."](#) on page 255.

Using incremental wear, the value entered by the user will be added (or subtracted if it is negative) to the absolute value of the wear. After pressing [ENTER] to accept the new value, the wear field will show the resulting absolute value.

Initial wear	Incremental wear	Total wear
1	0.2	1.2
1	-0.2	0.8
-1	0.2	-0.8
-1	-0.2	-1.2

16.

TOOL AND MAGAZINE TABLE
Tool and tool magazine table.



CNC 8060
CNC 8065

(REF: 1402)

Select the type of wear values to enter, incremental or absolute.

The tool offset wear (for length, radius, tip radius and offsets) may be entered with either absolute or incremental values. The value shown by their respective fields in the tool table are always absolute.



After pressing this icon, the CNC shows the dialog box for configuring the tool table. Here, the user can define whether the wear values being entered are incremental (box checked) or absolute (empty unchecked). By default, the wear value being entered will be absolute.

When selecting an incremental wear, it is possible to define the maximum increment possible; by default 0.5 mm (0.019685 inch). This data limits the wear increment to be edited, not the maximum absolute wear possible. If no value is defined, empty data, there will be no limit for the wear increment to be entered.

The option selected in the tool table will also be applied in the tool calibration mode.

Tool life monitoring

This group shows the data related to tool life monitoring. If a tool has been defined with several offsets, it is possible to manage the status of each one.

When managing the live of two or more offsets of the same tool, the list of the magazine positions (magazine table) only shows whether the tool has been rejected or not.

Type

It is used to activate and select the type of tool life monitoring (in time or number of operations).

Nominal life

Machining time (in minutes) or number of operations that the tool may carry out.

Real (actual) life

Machining time or number of operation the tool has carried out. The CNC updates this value when the tool is being used.

16.

TOOL AND MAGAZINE TABLE
Tool and tool magazine table.

FAGOR 

CNC 8060
CNC 8065

(REF: 1402)

Tool magazine

This information cannot be modified if the tool is in the spindle, on the changer arm or in the magazine.

Size

Tool size. The size determines the number of positions (pockets) the tool occupies in the magazine.

Size	Magazine positions it occupies.
Small	It only occupies its position. It takes no extra position.
Medium	It takes half of an additional position to the right and to the left.
Large	It takes a full additional position to the right and to the left.
Custom	The user defines the number of additional positions the tool occupies to its right and to its left.

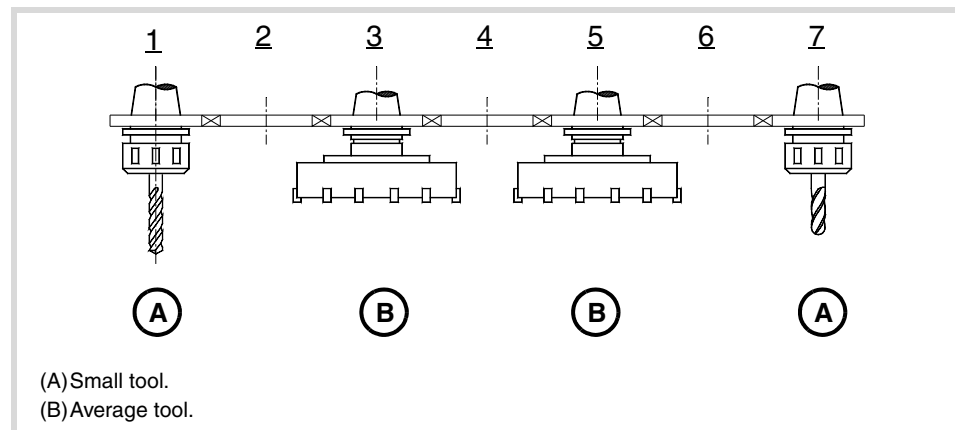

Positions to the right / Positions to the left

Space reserved in the magazine for the tool to the right and to the left of its position.

This data can be defined when the tool size is "custom".

Special

The tool always occupies the same position in the magazine.

Custom

Data defined by the manufacturer. On the setup panel of the tool table, it is possible to assign a text to any of the 4 parameters.

Data 1 / Data 2

These data show, in numerical format, the information selected by the manufacturer.

Data 3 / Data 4

These data show, in binary format, the information selected by the manufacturer.

Comment

Comment associated with the tool.

16.

TOOL AND MAGAZINE TABLE
Tool and tool magazine table.



CNC 8060
CNC 8065





(REF: 1402)

16.4 Tool table (simple mode).

The tools in the table appear sorted by the magazine they belong to starting from the first magazine and leaving the ground tools for last. The tools of a magazine are sorted by tool number and by offset number.

16.4.1 Vertical softkey menu.

The options shown for the tool table are.

Softkey.	Description.
	<p>Change the units for data display. The softkey highlights the units currently selected (millimeters or inches).</p> <p>The selected units are only valid for displaying data. For programming, the CNC assumes the units defined with the active function G70 or G71, or, when not programmed, the units set by the machine manufacturer (INCHES parameter).</p> <p>The CNC will display this softkey or not depending on how machine parameter MMINCHSOFTKEY has been set.</p>
	<p>The CNC is showing milling tool information (standard page or offsets); this softkey shows the information of the turning tools.</p>
	<p>The CNC is showing turning tool information (standard page or offsets); this softkey shows the information of the milling tools.</p>
	<p>Show the standard page (screen) of the tool table. The standard page (screen) shows the main data of the tools.</p>
	<p>Show the offset page (screen) of the tool table. The offset page (screen) shows the offsets of the tools.</p>

16.4.2 Configuring the tool data display

The data being shown in the tool table may be set up in the full tool table from the vertical softkey menu.



Softkey to access the setup panel of the tool table. When pressing this softkey, the CNC shows a dialog box to carry out the following actions.

- Select the data to be shown in the tool table. To show or hide a data, activate or cancel its check box.
- Define whether the wear is entered either with an incremental or with an absolute value.

16.

TOOL AND MAGAZINE TABLE
Tool table (simple mode).

16.4.3 Data of the M tools (standard page - screen-).

The standard page (screen) shows the main data of the tools, in this case, the tools that not specific for turning. The table highlights in color the active tool.

M TOOLS: STANDARD										
T	D	Mz	icon	Name	L	L W	R	R W	Rp	Rp W
1	1	1			75.0000	0.0000	25.0000	0.0000	0.0000	0.0000
2	1	1			100.0000	0.0000	7.5000	0.0000	0.0000	0.0000
3	1	1			75.0000	0.0000	5.0000	0.0000	1.0000	0.0000
4	1	1			70.0000	0.0000	4.0000	0.0000	0.0000	0.0000
5	1	1			85.0000	0.0000	2.5000	0.0000	0.0000	0.0000
6	1	1			85.0000	0.0000	2.5000	0.0000	0.0000	0.0000
7	1	1			80.0000	0.0000	5.0000	0.0000	5.0000	0.0000
8	1	1			65.0000	0.0000	3.0000	0.0000	0.0000	0.0000
9	1	1			100.0000	0.0000	10.0000	0.0000	0.4000	0.0000
10	1	1			85.0000	0.0000	7.5000	0.0000	0.0000	0.0000
11	1	1			65.0000	0.0000	5.0000	0.0000	0.0000	0.0000
12	1	1			125.0000	0.0000	12.0000	0.0000	0.0000	0.0000
13	1	1			135.0000	0.0000	25.0000	0.0000	0.0000	0.0000

Radius

Column.	Description.
T	Tool number.
D	Tool offset number.
Mz	Magazine it belongs to.
icon	Type of tool offset.
Name	Tool name.
L	Length.
L W	Length wear.
R	Radius.
R W	Radius wear.
Rp	Tip radius.
Rp W	Tool tip radius wear.
Lc	Cutting length.
Ae	Entry angle.
icon	Turning direction.

16.

TOOL AND MAGAZINE TABLE
Tool table (simple mode).



CNC 8060
CNC 8065

(REF: 1402)

16.4.4 Data of the T tools (standard page - screen-).

The standard page (screen) shows the main data of the tools, in this case, the ones for turning. The table highlights in color the active tool.

T TOOLS: STANDARD											
T	D	Mz			Name	A	B	C	Lc	Rp	Rp V
15	1	1				89.0000	5.0000	91.0000	4.0000	1.5000	0.000
16	1	1				90.0000	6.0000	0.0000	25.0000	3.0000	0.000
17	1	1				90.0000	4.0000	90.0000	2.5000	0.0000	0.000

Cutter's cutting angle

Column.	Description.
T	Tool number.
D	Tool offset number.
Mz	Magazine it belongs to.
icon	Type of tool offset.
icon	Location code (shape).
icon	Tool-holder orientation.
Name	Tool name.
A	Cutter angle.
B	Cutter width.
C	Cutting angle of the cutter.
Lc	Cutting length.
Rp	Tip radius.
Rp W	Tool tip radius wear.

16.

TOOL AND MAGAZINE TABLE

Tool table (simple mode).



CNC 8060
CNC 8065

(REF: 1402)

16.4.5 Data of the M/T tools (offset page - screen-).

The offset page (screen) shows the offsets of the tools. The table highlights in color the active tool.

T TOOLS: OFFSETS										
T	D	Mz		Name	Off. X	OW X	Off. Y	OW Y	Off. Z	OW Z
15	1	1			0.0000	0.0000	0.0000	0.0000	0.0000	0.0000
16	1	1			0.0000	0.0000	0.0000	0.0000	0.0000	0.0000
17	1	1			0.0000	0.0000	0.0000	0.0000	0.0000	0.0000

Edge

Column.	Description.
T	Tool number.
D	Tool offset number.
Mz	Magazine it belongs to.
Name	Tool name.
Off. X	Tool offset on each axis.
OW. X	Tool offset wear on each axis.

16.4.6 Editing the tool table.

With the simple tool table, it is only possible to edit the data of the tools. Neither tools nor offsets can be added or removed, uploaded or downloaded or change tools from one magazine to another.

The table allows editing all the fields except the following. These fields may be modified at the full tool table.

- Tool number.
- Tool offset number.
- Magazine it belongs to.
- Type of tool offset.
- Location code (shape).
- Tool-holder orientation.
- Turning direction.

16.

TOOL AND MAGAZINE TABLE
Tool table (simple mode).



CNC 8060
CNC 8065

(REF: 1402)

16.5 Operations with the tool table (full mode).

16.5.1 Editing the tool table

Initialize table

The table can only be initialized when the CNC is "READY". The table is initialized from the vertical softkey menu.



When resetting the table, all the tools are deleted from the list, including those in the spindle and on the tool changer arm. It also initializes the active-tools table and the magazine tables because the available tools have been erased.

Adding/removing a tool to/from the list

A tool may be added or deleted only when it is selected on the tool list. Both operations are carried out from the vertical softkey menu.



Add a tool to the list.

It adds a new tool to the list. The tool is added to the list at the first free position.



Remove a tool from the list.

It removes a tool from the list. A tool cannot be removed if it is in the magazine, in the spindle or on the tool changer arm.

Data editing

Proceed as follows to fill out the tool table data:

- 1 Select the tool to be set from the list and press [ENTER] to access its data.
- 2 Configure the table to show only the data that may be defined hiding the rest.
- 3 Define the tool data. Every time a new value is defined, press [ENTER] to validate it.

When a tool has several offsets, all the data of an offset may be copied to another offset. This operation is carried out from the softkey menu.



These softkeys may be used to copy on to the clipboard the data of the offset being displayed and then paste it to another offset.

- 4 Make a safety backup copy of the tool data out to a file.

Key.	Meaning.
	Move the cursor through the table data.
	Accept the new value.
	Activate/deactivate the selection box. Open/close pop-up menus.
	Move the cursor within a data.
	Select the line before or after the comment.
	Move the cursor to the beginning or end of the comment line.

16.

TOOL AND MAGAZINE TABLE
Operations with the tool table (full mode).

FAGOR

CNC 8060
CNC 8065

(REF: 1402)

16.6 Active-tools table

This table shows the list of available tools and which one is active in each channel.



The table is divided in two panels. To switch panels, press the [FOCUS] key.

16.

TOOL AND MAGAZINE TABLE
Active-tools table

Tools			Active tools	
Tool	Name	Position	Channel 1	Channel 2
1		1	4	2
2		2		
3		3		
4		C1		
5		5		
6		6		
7		7		
8		8		
9		9		
10		10		
11		11		
12		12		
13		13		
14		14		
15		15		
16		16		

Active tools	
Channel 1	Channel 2
T	4
Name	
Status	<input checked="" type="checkbox"/>
Family	0
Active d	1
Remaining life	Not mont.
L	65
R	8

Tool of the position selected on the list	
T	10
Name	
Status	<input checked="" type="checkbox"/>
Family	0
D	1
Remaining life	Not mont.
L	65
R	4

(A) Tool listing.
 (B) Active tools.
 (C) Tool selected on the list.

The left panel shows the list of the available tools and the right panel shows the data of the active tool in each channel.

Tool listing

For each tool, it indicates the position and the magazine where it is located, whether it is a ground tool or the tool is active in a channel. The CNC updates data of the list every time a tool change is carried out.

It is the same list that appears in the tool table. See ["16.3.2 The tool list"](#) on page 248.

Active tools

It shows the data of the active tool in each channel and also the data of the tool selected on the list. It is also possible to change the tool of the spindle. See ["16.6.2 Changing the tool of the spindle"](#) on page 263.

The tool data cannot be edited on this screen. The data shown here is defined in the tool table.







CNC 8060
CNC 8065

(REF: 1402)

16.6.1 Softkey menus.

Vertical softkey menu.

Softkey.	Description.
	<p>Change the units for data display. The softkey highlights the units currently selected (millimeters or inches).</p> <p>The selected units are only valid for displaying data. For programming, the CNC assumes the units defined with the active function G70 or G71, or, when not programmed, the units set by the machine manufacturer (INCHES parameter).</p> <p>The CNC will display this softkey or not depending on how machine parameter MMINCHSOFTKEY has been set.</p>
	<p>It initializes the tool table. Initializing the tables eliminates all the tools from the list. It also initializes the active-tools table and the magazine tables because the available tools have been erased. The CNC will request confirmation of the command.</p>
	<p>Saves the table data in a file. See "16.1.3 Save and load the tables" on page 242.</p>
	<p>Recall the table data previously saved in a file. Bear in mind that loading the tool table initializes the magazine tables and the active-tools table. See "16.1.3 Save and load the tables" on page 242.</p>
	<p>Print the table in the pre-determined printer or save it as a file (prn format) at the CNC. See "16.1.4 Printing the tables" on page 244.</p>

16.6.2 Changing the tool of the spindle

It is possible to change the tool of the spindles from the active tools panel. The tool to be placed must be defined in the tool table. To change the active tool, follow these steps.

- 1 Use the cursor to select the active tool to be modified and enter the number of the new tool.
- 2 Press the [CYCLE START] key to load the tool automatically or the [ENTER] key to update the positions list after a manual tool change.
- 3 The tool list will show that the tool is in the spindle.

16.

TOOL AND MAGAZINE TABLE
Active-tools table

FAGOR 

CNC 8060
CNC 8065

(REF: 1402)

16.7 Table for the status of the tool change process

This screen monitors the tool changes being executed in each channel.



It indicates the following for each tool change process:

- The type of change selected and the magazine involved.
The type of change refers to the type of operation being carried out or to be carried out when executing function M06. The possible types of change are load a tool into the spindle or load and unload a ground tool from the magazine through the spindle.
- The "execution " LED informs that the tool change process is running and that the magazine is carrying out an operation.
- The "status" LED informs on whether the magazine is in an error state or not. To eliminate the error condition, press the reset softkey in the magazine table.



16.

TOOL AND MAGAZINE TABLE
Table for the status of the tool change process



CNC 8060
CNC 8065

(REF: 1402)

16.8 Magazine table

Up to four different magazines may be configured. Each magazine has a table showing the tool distribution in the magazine and which table is in the spindle and on each holder of the changer arm (if any). The CNC updates the table data every time a tool is changed.

The screenshot shows a software interface for the 'Magazine table'. It is divided into two main panels: 'Magazine positions' (left) and 'Information' (right).

Magazine positions table:

Position	Tool	Remaining life	Famil
1	1	Not monit.	0
2	2	Not monit.	0
3	3	Not monit.	0
4	4	Not monit.	0
5	5	Not monit.	0
6	6	Not monit.	0
7	Free		
8	8	Not monit.	0
9	9	Not monit.	0
10	10	Not monit.	0
11	11	Not monit.	0
12	12	Not monit.	0
13	13	Not monit.	0
14	14	Not monit.	0
15	15	Not monit.	0
16	16	Not monit.	0

Information panel:

- Magazine status:** Resting, Status: ●
- Tool changer arm:** CH1, CH2
- Tool of the position selected on the list:**
 - T: 1 Left pos., 0
 - Name: Small
 - Status: ■ Right Pos., 0
 - Special:

Labels (A) and (B) are placed on the screenshot to identify the two panels.

(A) Magazine positions.
 (B) Magazine information.

The table is divided in two panels.

The left panel shows the list of magazine positions. For each position, it indicates whether it is free, disabled or has a tool. For each tool, it shows the remaining life time (when using tool life monitoring) and the family it belongs to.

The right panel is informative only; it cannot be selected. This panel shows information about the magazine status, about the tools in the tool changer arm and about the tool selected on the list. Optionally, it may show information on the type and configuration of the magazine.

16.

TOOL AND MAGAZINE TABLE
Magazine table



CNC 8060
CNC 8065

(REF: 1402)

16.8.1 Softkey menus.

Vertical softkey menu.

Softkey.	Description.
	Show more options on the softkey menu.
	Load / unload a tool to / from the tool changer arm. This icon is only available in magazines with tool changer arm. See "16.9.2 Load / unload a tool to / from the tool changer arm" on page 272.
	Search for a text in the table. When selecting this option, the CNC shows a dialog box requesting the text to be found. See "16.1.2 Search for a text in the tables" on page 241.
	Load a tool into the magazine. See "16.9.1 Loading / unloading tools to / from the magazine" on page 270.
	Unload the tool from the magazine. See "16.9.1 Loading / unloading tools to / from the magazine" on page 270.
	Initialize (reset) the magazine table. Initializing the tables eliminates all the tools from the list. It also initializes the active-tools table because the tool arrangement in the magazine may have changed. The CNC will request confirmation of the command.
	Saves the table data in a file. See "16.1.3 Save and load the tables" on page 242.
	Recall the table data previously saved in a file. Bear in mind that loading the magazine tool initializes the active-tools table. See "16.1.3 Save and load the tables" on page 242.
	Print the table in the pre-determined printer or save it as a file (prn format) at the CNC. See "16.1.4 Printing the tables" on page 244.
	Enable or disable the magazine position selected with the cursor.
	Reset the magazine. Eliminates the error status of the tool manager. This icon is only available when an error occurs at the tool manager.
	Magazine information. Show or hide the magazine data.
	Initialize the magazine data. The CNC will request confirmation of the command. It initializes all the magazine positions assigning T1 to position 1, T2 to position 2 and so on. The tools must exist and must not be in another magazine. It also initializes the list of tools and the active-tools table because the tool arrangement in the magazine may have changed.

16.

TOOL AND MAGAZINE TABLE
Magazine table

CNC 8060
CNC 8065

(REF: 1402)

16.8.2 List of magazine positions

The list of magazine positions appears on the left panel of the tool magazine table. For each position, it indicates whether it is free, disabled or has a tool. For each tool, it shows the remaining life time (when using tool life monitoring) and the family it belongs to.

Magazine position

The status of a position is indicated with a symbol next to the position number.

- The position is free (white filled circle).
- The position is semi-free (black-and-white filled circle).
- The position is occupied (black filled circle).
- The position is disabled (red filled circle).

Tool number

Number of the tool occupying the magazine position.

Remaining life

If the tool life monitoring is active, shows the remaining life, either in machining time or in the number of operations to be carried out or the tool status (rejected or worn out).

Tool family

Family the tool belongs to, defined by the user in the tool table.

16.**TOOL AND MAGAZINE TABLE**
Magazine table**FAGOR** **CNC 8060**
CNC 8065

(REF: 1402)

16.8.3 Magazine information

The right panel shows different information about the status of the tool magazine and the tool changer arm. This information is grouped as follows:

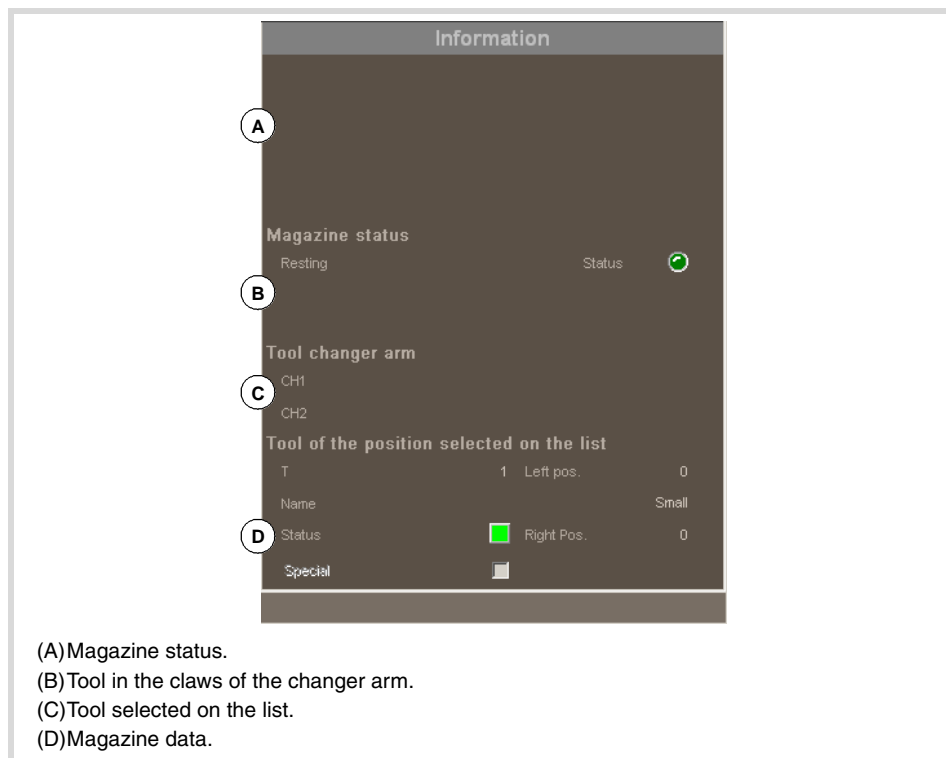

Magazine status

This area shows the operation being carried out in the magazine.

- In standby: The magazine is in standby.
- Loading: A tool is being loaded into the magazine.
- Unloading: A tool is being unloaded from the magazine.



The "Status" led informs the user whether the magazine is in an error state or not. To eliminate the error condition, press the reset softkey in the magazine table.

Change status

If the magazine is involved in a tool change at a given time, it shows the information about the status of that change; the operation is carried out when executing an M06, manager status (in execution or at rest) and the status of the change process (whether it is in error or not).

Tool information

It shows the data related to the magazine of the tool selected from the list. The "status" led informs about the tool status.

- Green The tool is available.
- Yellow The tool life is about to expire.
- Red The tool is expired (worn out) or has been rejected by the PLC.

16.

TOOL AND MAGAZINE TABLE Magazine table



CNC 8060
CNC 8065

(REF: 1402)

Tools in the changer arm

This area shows which are the tools that occupy each claw (holder) of the changer. It shows the number and size of each tool.

Magazine data



Description of the type of magazine. To show and hide this information, press the information softkey.

16.

TOOL AND MAGAZINE TABLE
Magazine table

FAGOR 

CNC 8060
CNC 8065

(REF: 1402)

16.9 Operations with the magazine table

16.9.1 Loading / unloading tools to / from the magazine

The tools may be loaded and unloaded to/from the magazine manually or automatically. When done manually, the positions list must be updated.

Manual load/unload

The operator places the tools directly in the magazine without using the CNC. Then, the positions list must be updated.

Automatic load/unload

The operator places the tools in the spindle and the CNC places the tool in the magazine. The positions list is updated automatically.

Initialize table

The table can only be initialized when the CNC is "READY". The table is initialized from the vertical softkey menu. The CNC offers two ways to initialize the table.



Initializing the table eliminates all the data about the position of the tools in the magazine. It also initializes the active-tools table because the tool arrangement in the magazine has been changed.



When initializing the table, it initializes the magazine positions assigning T1 to position 1, T2 to position 2 and so on. The tools must exist and must not be in another magazine.

It also initializes the active-tools table because the tool arrangement in the magazine may have changed.

Load a tool



The tool is loaded into the magazine using the vertical softkey menu. Only the tools defined in the tool table may be loaded into the magazine and they must be defined as ground tools. In other words, they must not be in any position of the magazine, of the spindle or in the claws of the tool changer.



Even if the magazines are configured for not admitting ground tools while machining, they may be loaded into the magazine through this maneuver.

Depending on tool size, when it is loaded into the magazine, it may affect several positions.

Magazine management using the "Load tool" softkey.

This type of management is valid for loading tools both automatically and manually. After pressing the softkey, the user is asked what kind of loading to do.

- 1 Press the softkey associated with tool loading.
- 2 Enter the tool number and the magazine position to insert it. By default, it offers the position selected on the list with the cursor.
- 3 Press the [CYCLE START] key to load the tool automatically by means of the spindle or the [ENTER] key to update the positions list after loading manually.
 - Automatic loading (pressing [START]). The CNC loads into the magazine a tool previously defined in the table. It is loaded from ground through the spindle.
 - Manual loading (pressing [ENTER]). The CNC assume that the tool defined in the table has already been manually loaded into the magazine. It updates the magazine list.

16.

TOOL AND MAGAZINE TABLE
Operations with the magazine table



CNC 8060
CNC 8065

(REF: 1402)

Magazine management using the positions list.

This type of management is only valid for loading tools manually. It lets update the list of positions after having placed the tools directly in the magazine, without using the CNC.

- 1 Select a magazine position from the list and enter the number of the tool it occupies it.
- 2 Press [ENTER] to update the positions list.

Unloading a tool

The tool is unloaded into the magazine using the vertical softkey menu. After unloading a tool from the magazine, it becomes a ground tool.

Magazine management using the "Unload tool" softkey.

This type of management is valid for unloading tools both automatically and manually. After pressing the softkey, the user is asked what kind of loading to do.

- 1 Press the softkey associated with tool unloading.
- 2 Enter the number of the tool to be unloaded.
- 3 Press the [CYCLE START] key to unload the tool automatically to the spindle or the [ENTER] key to update the positions list after unloading manually.
 - Automatic unload (pressing [START]). The CNC unloads from the magazine a tool defined in the table. It is unloaded to ground through the spindle.
 - Manual loading (pressing [ENTER]). The CNC assumes that the tool defined in the table has already been manually loaded from the magazine. It updates the magazine list.

Magazine management using the positions list.

This type of management is only valid for unloading tools manually. It lets update the list of positions after having removed the tools directly from the magazine, without using the CNC.

- 1 Select a magazine position from the list and delete the number of the tool it occupies it.
- 2 Press [ENTER] to update the positions list.

16.9.2 Load / unload a tool to / from the tool changer arm



A tool is loaded/unloaded to/from the claws (holders) of the changer arm using the vertical softkey menu. To insert a tool in the holders of the changer arm (when available), it must be placed in the magazine. Ground tools cannot be placed in the claws (holders) of the tool changer arm.

Nor can the tools that are in the holders of the tool changer arm be inserted in the spindle.

To load or unload one of these tools:

- 1 Press the softkey associated with the operations with the changer arm.
- 2 Define the tool number in the positions of the tool changer arm.

When using a two-holder changer arm, there may not be tools in the spindle and in the second holder of the changer arm at the same time.

- 3 Press [ENTER] to update the table.

16.

TOOL AND MAGAZINE TABLE
Operations with the magazine table



CNC 8060
CNC 8065

(REF: 1402)

17.1 Interface description.

The utilities mode screen shows the following information:

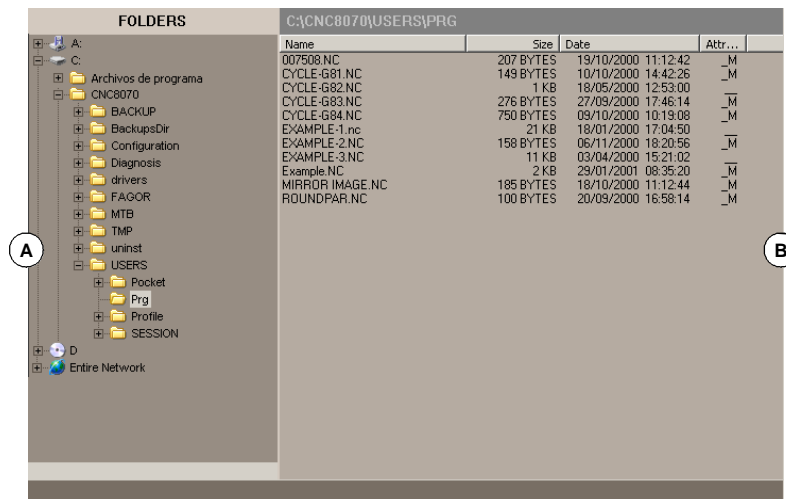

A Folder tree. The tree shows the folders that may be accessed from the CNC, as well their structure.

B List of files saved in the selected folder.

When selecting a folder, the bottom of the window will show the number of files contained in the folder and the total size (bytes) they amount to.

List of files. Attribute column (modifiable and hidden files).

The attribute column only shows the letters of the attributes currently selected. Those not selected will appear as "_".

H The file is hidden and it will not appear when selecting a program for editing or execution.

M The file may be modified; in other words, edited, copied, deleted, etc.









17.1.1 Softkey menus.

Horizontal softkey menu.

Softkey.	Description.
Sorted by.	Sorting the list of files.
Options.	Set how the file list will be displayed.
File search.	Search files.
Select all.	Select all the files from the list.
Invert selection.	Invert file selection.
New folder.	Create a new folder.
Access codes.	Manage CNC passwords.
Automatic backup.	Do a backup of the selected folder.
Restore backup.	Restoring data saved in a backup.
Backup options.	Configuring backup options.

Vertical softkey menu.

The vertical softkey menu always shows all the options associated with this operating mode regardless of the active screen.

Softkey.	Description.
	Show more options on the softkey menu.
	Cut the selected files onto the clipboard. With this option, when pasting the files to their new location, they are erased from the current folder.
	Copy the selected files onto the clipboard.
	Paste the files from the clipboard into the selected folder. If the files were placed using the "Cut" option, they will be removed from their original location. The contents of the clipboard are not eliminated after "pasting". Therefore, this pasting operation may be repeated as often as you wish.
	Rename the selected folder or file. If there is a folder or file already with the new name, the change will be ignored. The files being used cannot be renamed (for example, the file selected in automatic mode).
	Change the "modifiable" attribute of the selected files. The attributes column shows the letter -M- indicating that the program may be modified. When a program is NOT modifiable, its contents may be viewed; but cannot be modified.
	Change the "hidden" attribute of the selected files. The attributes column shows the letter -H- indicating that the program will be hidden (not visible). This attribute allows protecting the files so they are not displayed when selecting a program to be edited or executed. However, a hidden program may be deleted if its name is known; therefore, it is recommended to remove the modifiable attribute (M) in order to avoid deleting it.
	Encrypt files. Encrypting may be used to protect any file (part-program, subroutine, etc.) making it illegible so it cannot be used by anyone else.
	Delete the selected folder or files. To delete the files, the CNC will show a dialog box requesting confirmation of the command whereas the empty folders will be deleted directly without requesting confirmation. The folders can only be deleted if they are empty. The files being used cannot be renamed (for example, the file selected in automatic mode).

17.

UTILITIES MODE
Interface description.



CNC 8060
CNC 8065

(REF: 1402)

17.2 Set how to display the list of programs.

Sorting the list of files.

The "Sort by" softkey is used to order the list of files. When selecting this option, the softkey menu shows the different ordering options.

The file list may be ordered alphabetically, by size, by data or by type. When pressing the same ordering criteria twice, the CNC toggles from ascending to descending and vice versa.

Customizing options.

The "Options" softkey is used to personalize how the program listing will be displayed on the screen. When selecting this option, the softkey menu shows the following personalizing options.

Update

This option updates the list of files showing the files of the folder currently selected. Only when the "auto-update" option is not active.

Auto-update

When this option is selected, every time a folder is selected, the CNC will automatically update the list of files.

Column adjust

When this option is selected, the columns of the file lists will adjust to the text they contain so as to show the text that may be truncated because it is too long.

Reset all

It closes the folder tree (layout) and it only shows the devices accessible from the CNC.

Show hidden files

When this option is selected, the file list shows all the files of the selected folder even those having the "hidden" attributes. Otherwise, these files will not be shown.

17.**UTILITIES MODE**
Set how to display the list of programs.**CNC 8060**
CNC 8065





(REF: 1402)

17.3 Select files and create folders.

Having selected a group of files, they may be deleted, copied, cut or their attributes may be changed by pressing the relevant icon.

Select files and folders.

- To select files or folders, besides the mouse, the following keys may be used. To select a group of files from the keyboard, keep the [SHIFT] key pressed while the moving the cursor. To add or remove a file from the selection, keep the [CTRL] key pressed and place the cursor on the file and press [SPACE] key.

Key.	Meaning.
	It switches the window focus.
	With the focus on a folder, it closes and opens the submenu of folders.
	To moves the focus element by element.
	To move the focus page by page.
	To move the focus to the beginning or end of the list.

- Using the alphanumeric keyboard, pressing a key will select the first element starting with that letter. Pressing it again will select the second one and so on.
- Using the "file search" option of the softkey menu permits looking for all the files that contain the indicated text.

Select files from the softkey menu.

Select all.

Select all the files from the list. The selection will be canceled by moving the cursor.

Having selected a group of files, they may be deleted, copied, cut or their attributes may be changed by pressing the relevant icon.

Invert selection

It inverts the file selection made selecting the files that appeared unselected and vice versa.

Create a new folder from the softkey menu.

When selecting this option, the CNC shows a dialog box requesting the file name. Write the new name and select one of the buttons to accept it or ignore it. If when defining the folder name, there is already a folder with the same name, it will NOT create the new folder.

17.

UTILITIES MODE
Select files and create folders.



CNC 8060
CNC 8065

(REF: 1402)

17.4 Search in files

It is used to search files. When selecting this option, the CNC shows a dialog box where the following data may be defined:

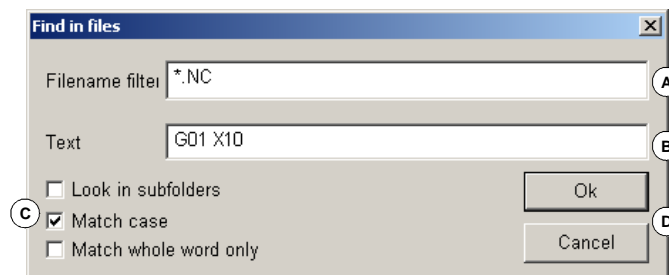

A Description of the files to be searched. The "*" and "?" wild characters may be used on the search, meaning:

- * Any character string.
- ? Any character.

In such a way that:

- * Looks for all the files.
- *.*NC Looks for all the files having the extension "NC".
- exa*.* Looks for all the files beginning with "exa".

B Text included within the files.

C Defines the search criteria.

- Look in the sub-folders.
- Ignore uppercase and lowercase.
- Consider the text to find as a whole word.

D To start or cancel the defined search.

After defining the search options, place the cursor on one of the lower buttons to accept or cancel the defined search and press [ENTER]. The file window will show the list of the programs found.

17.

UTILITIES MODE
Search in files

FAGOR 

CNC 8060
CNC 8065

(REF: 1402)

17.5 Protection passwords

The passwords may be used to define each of the codes that the user will have to enter in order to access certain CNC functions. If entered correctly, it stores it and it does not request it again unless the CNC is turned off. If the password is wrong, the requested action cannot be carried out and it requests it again every time.

In a CNC with a write-protected disk, when the CNC is powered up in setup mode, it does not request the protection passwords. When the CNC is powered up in user mode, it requests the protection passwords.

17.

UTILITIES MODE
Protection passwords

How to set the protection passwords

Press the "Passwords" softkey to access the password setting screen. From this screen, it is possible to define, modify or delete the passwords. If this screen is protected, pressing the softkey will request the general password.

Each password may be up to 10 ASCII characters long. It is case sensitive.

The "Delete all" softkey deletes all the passwords defined.

Description of protection passwords.

General password

It is requested when trying to access this password setting screen.

PLC

It is requested when trying to carry out the following actions at the PLC:

- Editing the PLC program. When entering the wrong password, the PLC program opens as read-only.
- Adding a file to the project.
- Deleting a file.
- Renaming a file.
- Editing PLC messages. When entering the wrong password, the PLC messages may be neither displayed nor edited.
- Generate PLC.
- When accessing to the "Commands" service options.
- In monitoring, when modifying the status of a resource.

Machine parameters

The CNC requests a password when attempting to carry out the following actions:

- Modifying the value of a parameter.
- Initialize a table.
- Loading a table.
- When starting the CNC application and the unit is powered up in setup mode.
- Do a restore of the CNC data.

Customizing

It is requested when entering the FGUIM application. When entering the wrong password, it will not be possible to access the application.



CNC 8060
CNC 8065

(REF: 1402)

Machine parameters for kinetics

It is requested when trying to carry out the following actions in the machine parameter tables for the kinematics: If not set, it will apply the password used in the rest of the machine parameters.

- Modifying the value of a parameter.
- Initialize a table.
- Loading a table.

Administrator mode

It is requested to start the unit up in administrator mode. The access to the administrator mode is enabled with the validation code. If you don't have this software option, you will not be able to access the administrator mode.

17.

UTILITIES MODE
Protection passwords

FAGOR 

CNC 8060
CNC 8065

(REF: 1402)

17.6 Data safety backup. Backup - Restore



The CNC only allows doing the backup or restore when there is no power (e.g. E-stop button pressed).

This option may be used to make a backup of the CNC configuration (OEM and user data) to be restored later one if necessary. Backup/restore is not possible while the CNC is in execution.

Softkey.	Meaning.
	Make a backup of CNC data.
	Restore data from the backup .

Make a backup of CNC data.

Data backup may be carried out when the CNC has been started up in SETUP mode or in USER mode.

On Windows explorer, select the folder where the backup will be saved. Press the "BACKUP" softkey and the CNC will display a window with the options to select the data to include in the backup.

Restore data from the backup .

OEM data may only be restored whe the CNC has been started up in SETU mode; if it has been started up in USER mode, only user data may be restored and the rest of the options are disabled. The restore option is protected by the "Machine parameters" password.

On Windows explorer, select the folder where the backup has been saved. Press the "RESTORE" softkey and the CNC will display a window with the options to select the data to include in the backup. If the selected folder does not contain one of the backups, its option will appear disabled. The CNC application must be restarted after restoring a backup.

Select the data to be included in the backup or restore.

The selected options will be kept until they are modified.

OEM data.

- Machine parameters. Backup/restore of CNC machine parameters. The backup saves the data in the BACKUP_OEM_MP.zip file.
In order for the CNC to properly do the backup and restore of the volumetric compensation tables, it is recommended to save them in the folder ...MTB/SUB.
- Tables. Backup/restore of CNC tables; fixtures, zero offsets and arithmetic parameters. The backup saves the data in the BACKUP_OEM_TABLES.zip file.
- Tools and tool magazines. Backup/restore of tool and tool magazine tables. The backup saves the data in the BACKUP_OEM_MZTOOLS.zip file.
- Servo parameters. Backup/restore of drive machine parameters. The backup saves the data in the BACKUP_OEM_DRIVEMP.zip file.
- Subroutines. Backup/restore of OEM subroutines. The backup saves the data in the BACKUP_OEM_SUB.zip file.
- PLC. Backup/restore of the PLC; PLC programs, messages and errors. The backup saves the data in the BACKUP_OEM_PLC.zip file.
- Configuration and screens. Backup/restore of CNC configuration and screens. The backup saves the data in the BACKUP_OEM_CONFIG.zip file.

17.

UTILITIES MODE
Data safety backup. Backup - Restore



CNC 8060
CNC 8065

(REF: 1402)

User data.

- Programs.

Backup/restore of user programs, pockets, profiles, etc. The backup saves the data in the BACKUP_USER_PRG.zip file. This backup includes the following folders.

..\Users\Prg ..\Users\Pocket ..\Users\Profile ..\Users\CycleData

17.

UTILITIES MODE

Data safety backup. Backup - Restore



CNC 8060
CNC 8065

(REF: 1402)

17.7 Encrypting files

Encrypting may be used to protect any file (part-programs, subroutines, etc.) making it illegible so it cannot be used by anyone else. An encrypted program cannot be edited at the program editor or at the PLC and is not displayed during execution. An encrypted file may be copied, deleted, etc. like any other file.



When pressing the "Encrypt file" softkey, the CNC encrypts the file selected with the cursor. Encrypting maintains the original file and generates a new encrypted file with the same name but with the extension fcr. If the CNC encrypts the file successfully, it asks the user whether or not the original file is to be deleted leaving only the encrypted one. This file cannot be unencrypted at the CNC; therefore, we suggest to save a copy of the original file somewhere safe.

Encrypting files and the manufacturer's (OEM's) password.

The encrypting algorithm takes into account the OEM password (general access code). If this password does not exist when trying to encrypt a file, the CNC will show the relevant warning and will abort the process. If after encrypting a file, the OEM password changes, the CNC will no longer be able to read the file.

When the CNC executes an encrypted program or subroutine, it checks whether the current OEM password matches the one used to encrypt the file. If the two passwords do not match, the CNC will not be able to execute the program or subroutine and will issue the relevant error message. A file encrypted in a CNC may be executed in another CNC if the OEM passwords of the two CNC's are the same.



In the case of a PLC program, there is no need to encrypt the source file because compiling it is enough. The source file may be deleted.

17.

UTILITIES MODE
Encrypting files



CNC 8060
CNC 8065

(REF: 1402)

18.1 Appearance of the PLC mode

In this operating mode, the PLC may be accessed to check its operation or the status of the different PLC variables. It is also possible to edit and analyze the PLC program as well as the message and error files of the PLC.

At a CNC with a write-protected (read-only) disk, working in user mode, the PLC program is write-protected and any changes made to it are temporary; i.e. it will disappear the next time the unit is turned on. To make the changes permanent, unprotect the PLC program by starting the unit up in setup mode and validating the changes made.

Interface description.



The PLC mode screen shows the following information. To switch windows, press the [FOCUS] key.

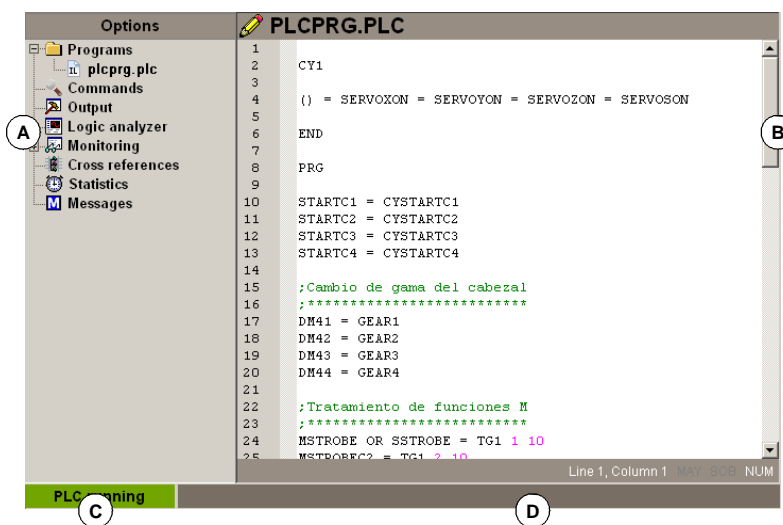

- A Service window that shows the list of the services available in the PLC environment.
- B Data window.
- C It shows the PLC status, running or stopped.
- D CNC messages.

Select the PLC services.

This operating mode may be displayed with several screens. Each of them corresponds to a PLC service. The exchange between the different services is carried out with the list of services.



The different services overlap each other. If several services active, it is possible to switch from one to another using the [NEXT] key, if it has been set accordingly. The services are switched in a rotary manner, in such a way that when pressing on the last active service, it shows the first one. To close a screen, press [ESC].





18.1.1 Icon description (vertical softkeys)

Horizontal softkey menu.

When selecting the PLC mode, the horizontal softkey menu will show the options associated with the PLC service currently selected. The set of options offered by this menu may be changed using the "+" softkey which offers a new set of options.

Vertical softkey menu.

The vertical softkey menu always shows all the options related to this operating mode.

Softkey.	Description.
	Show or hide the service window. This softkey toggles between the shared usage of the area of the PLC environment (that displays both the service window and the data window) and the full work screen (hiding the service window so the data window is expanded covering the whole area of the PLC environment).
	
	Find text. This softkey is used for searching a text in all the files of the project. The result will be shown at the "Outputs" service.
	Go to file. If the cursor is positioned on the result of a text search, a compiling error or a PLC resource, after selecting this option, it opens the corresponding file and the cursor goes to the line it refers to. This softkey only appears with the "Outputs" or "Cross references" service.
	Mnemonic language or contact language. This softkey toggles the display between the mnemonic language and the contact language (ladder diagram). This softkey only appears in the "Programs" service when monitoring a program.

18.

PLC
Appearance of the PLC mode



CNC 8060
CNC 8065

(REF: 1402)

18.2 "Programs" service

This service is used for managing the PLC project and its files.

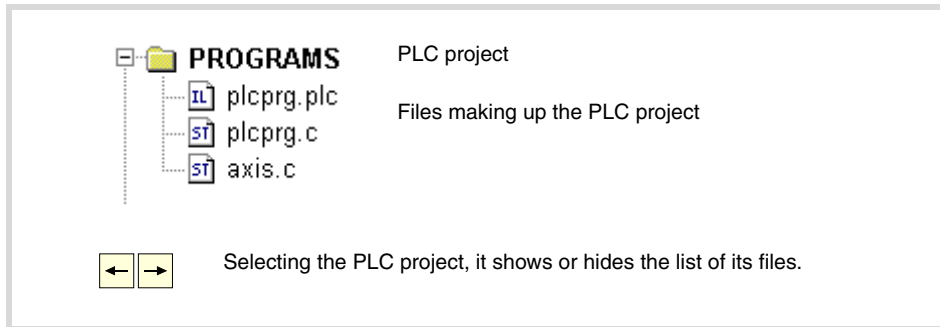

PLC project

The PLC project is a set of files that, once compiled, generate the PLC program.

When selecting the PLC project, the softkey menu will show the options to manage that project. Among these options, it is possible to add files to the PLC project and compile it.

Files of the PLC project

The PLC project may consist of several files edited in the following languages:

- Mnemonics or equations language (files with "plc" extension).
- Contac language (ladder diagram) (files with "ld" extension).
- C language (files with "c" extension).

The PLC project may consist of several files in the same language. Two files having the same name and different extension cannot belong to the same project.

When selecting a file, the softkey menu shows the options to manage that file. Among these options, it is possible to edit and monitor the file. These options will show the editing and monitoring screens.

18.

PLC
"Programs" service



FAGOR 

CNC 8060
CNC 8065

(REF: 1402)

18.2.1 Softkey menus. PLC project.

These options are used to create a PLC project and compile it to create the executable PLC program.

Softkey.	Description.
	Compile the PLC project to create the executable program.
	Add a file to the PLC project.
	Add a library to the PLC project.

PLC project "Generate PLC"

This option compiles and loads the PLC program based on the files that make up the PLC project. If an error occurs during compilation, the program will not be generated and the CNC will display a list of the detected errors.

The proper compilation of a file in mnemonic language or contact (ladder) language generates the equivalent files in both languages. That is why two files having the same name and different extension cannot belong to the same project because, when compiled, they are the same file.

PLC project "Add file"

This option is used to add a file to the PLC project. This file may be a new one or an existing one. When selecting this option, the CNC shows a list of the available files. To add a file to the PLC project.

- 1 Select the file from the list or write its name in the bottom window.
- 2 Press [ENTER] to accept the selection and add the file or [ESC] to cancel the selection and close the file listing.

When accepting the selection, the selected file will appear on the list that make up the PLC project.

18.

PLC
"Programs" service









CNC 8060
CNC 8065

(REF: 1402)

18.2.2 Softkey menus. Files of the PLC project.

When selecting a program of the PLC project at the service window, the softkey menu will offer the following options.

Softkey.	Description.
	Files of the PLC project "Edit". This softkey shows the editing window. See "18.3 Program editing" on page 288.
	Files of the PLC project "Monitoring". This softkey shows the monitoring window. See "18.6 Program monitoring" on page 301.
	Files of the PLC project "Eliminate". This softkey deletes the selected file of the PLC project (the file will still be available in the CNC's hard disk).
	Files of the PLC project "Rename". This softkey may be used to change the name of the selected file.
	Files of the PLC project "Copy". This softkey may be used to make a copy of the selected file. When selecting this option, the CNC shows a list with the programs stored at the CNC. To make a copy of the file: (1) Select the destination folder for the copy. (2) Define the file name at the bottom window. To replace an existing file, select it from the list. (3) Press [ENTER] to copy the file or [ESC] to cancel the selection and close the file listing.
	Files of the PLC project "Move up" When the PLC project contains several files, this softkey may be used to move the selected file up.
	Files of the PLC project "Move down" When the PLC project contains several files, this softkey may be used to move the selected file down.

18.

PLC
"Programs" service

FAGOR 

CNC 8060
CNC 8065

(REF: 1402)

18.3 Program editing

To edit a program, select it from the "Programs" service list and select the "Edit" option of the softkey menu. The PLC will show the right editor for the language of the selected program; a text editor if the program is in mnemonic language or C language or a contact (ladder) editor if the program is edited in contact (ladder) language.

Editor description

The text editor window (top image) and that of the contact (ladder) editor (bottom image) show the following information.

18.

PLC
Program editing

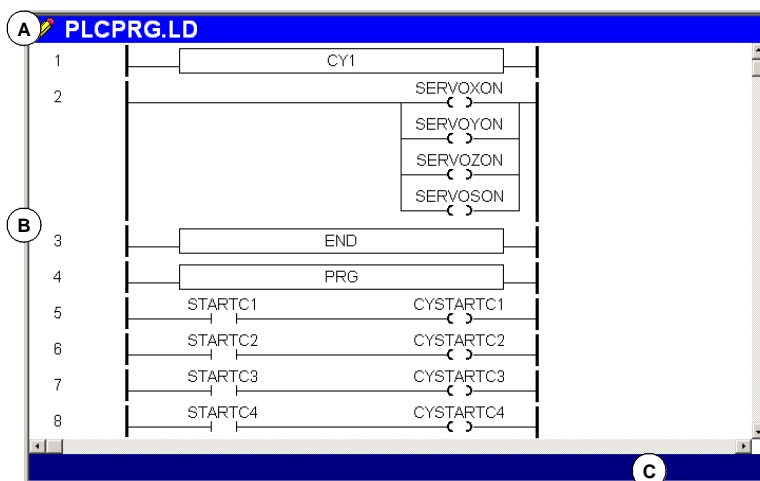
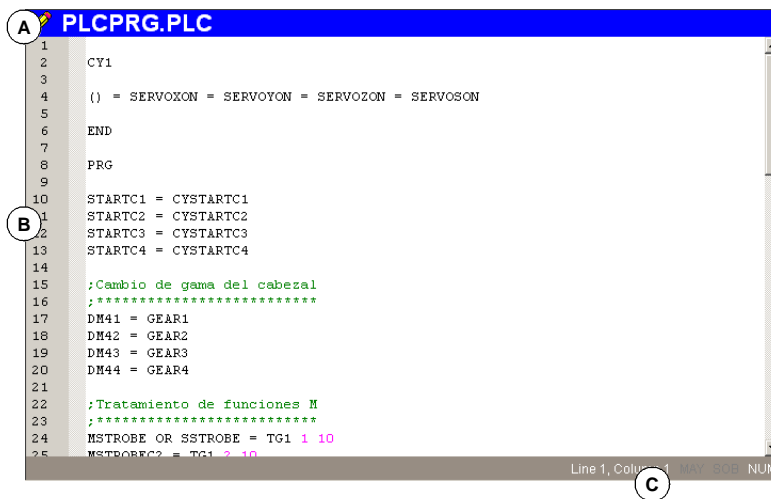

A Title bar.

Name of the program selected for editing. An "*" next to the program name means that the changes made to the program have not been saved (the program must be saved so they do not get lost).

B Edit area.

Line number and area for editing the program. A program edited in contact (ladder) language will contain numbered blocks representing the various elements.

C Status bar.

In a program edited in C language or mnemonic language, the bar shows information about the cursor position and the status of the editor options.

CAP Capital letters. When active, the text is always written in capital letters.

OVR Overwrite text. It toggles between overwriting and inserting text. When active, it overwrites the existing text.

NUM Numeric keypad active.

In a program edited in contact (ladder) language, the bar shows the comments of a contact and other messages.



CNC 8060
CNC 8065

(REF: 1402)

Program editor, Unicode format.

The editor of the CNC admits Unicode characters. When saving a program, the editor respects its original format, ANSI or Unicode, except when editing a Unicode character, in which case the CNC will always save the program in Unicode format.



Programs in Unicode format are not compatible with versions older than V4.0. A program in Unicode format cannot be edited or executed in a version older than V4.0.

A third-party text editor (like Windows notepad) may be used to convert Unicode format programs into ANSI format; but special characters that have no ANSI equivalent will be lost in the process.

Functionalities of the editor.

Zoom at the editor.

The editor has the following hotkeys to increase or decrease the size of the editor font. If the CNC has a mouse with a wheel, the [CTRL] key combined with this wheel can also be used to increase and decrease the size of the text font.

[CTRL]+[+] Zoom in.

[CTRL]+[-] Zoom out.

Multi-line blocks.

POCK.)

[

.C.M=0



The editor adjusts the long blocks to the size of the window dividing the block into several lines. On the right side of each cut line, the editor shows a symbol to indicate that the block continues in the next line.

Softkey menu

When accessing the PLC program editor, the horizontal softkey menu will show all the options associated with editing a file depending on the editing language.

18.

PLC
Program editing

FAGOR 

CNC 8060
CNC 8065

(REF: 1402)

18.4 Editing in C language or mnemonic language.

Horizontal softkey menu.

Softkey.	Description.
Analyze.	Analyze the program searching for errors.
File.	Recall, save, import or print a file.
Undo.	Undo the last modifications.
Operations with blocks.	Copy text, paste text and export text as an independent file.
Find/replace	Find a line or a text in the program and replace a text with another one.
Customizing.	Set the behavior, properties and appearance of the PLC editor.

Hotkey menu.

The following softkeys may be useful when editing.

Hotkey.	Function.
[CTRL]+[C]	Copy the selected text.
[CTRL]+[X]	Cut the selected text.
[CTRL]+[V]	Paste the selected text.
[CTRL]+[Z]	Undo the last change.
[CTRL]+[Y]	Redo the selected text.
[CTRL]+[G]	Save the program/Recover the original program.
[CTRL]+[+]	Zoom in.
[CTRL]+[-]	Zoom out.
[CTRL]+[HOME]	Move the cursor to the beginning of the program.
[CTRL]+[END]	Move the program to the end of the program.

18.

PLC
Editing in C language or mnemonic language.



CNC 8060
CNC 8065

(REF: 1402)

18.4.1 Softkey "Analyze".

This softkey analyzes the program searching for errors. The errors found will be displayed in the "Outputs" service window.



To close this window and return to the editor, press [ESC]. To return to the editor without closing the window, press the [NEXT] key.

18.4.2 Softkey "File".



This softkey is used to recall, save, import or print a file. When selecting this option, the softkey menu shows the available options. To return to the main menu, press the [BACK] key.

File "Restore original"

This softkey is used to recover the original file without the changes made since the last time it was opened. When selecting this option, the CNC requests confirmation of the command.

This option is only available when the "Save always" option is active. See "[18.4.6 Softkey "Customize".](#)" on page 294.

File "Save"

This softkey saves the file that is being edited.

This option is only available when the "Save always" option is not active. See "[18.4.6 Softkey "Customize".](#)" on page 294.

File "Save as"

This softkey saves the file, that is being edited, with a different name. After saving the file, one keeps editing the new file.

File "Include program"

This softkey is used to import the contents of a file saved at the CNC into the program that is being edited.

File "Print"

This softkey may be used to print the program in the pre-determined printer.

18.4.3 Softkey "Undo".

This softkey may be used to "undo" the last modifications made. The modifications are undone one by one starting from the most recent one. The CNC offers the following keyboard shortcuts to undo and redo the operations.

[CTRL]+[Z] Undo the last change.

[CTRL]+[Y] Redo the selected text.

18.4.4 Softkey "Operations with blocks".

This softkey is used to copy, cut and paste the information of a block or set of blocks and export this information as an independent program. This option is only available when there is a text selected in the program or on the clipboard. To select a text in the program, keep the [SHIFT] key pressed while moving the cursor.



When selecting this option, the softkey menu shows the available options. To return to the main menu, press the key for the previous menu.

Operations with blocks "Copy"

Copy the selected text onto the clipboard.

Operations with blocks "Cut"

Copy the selected text onto the clipboard and deletes it from the program.

Operations with blocks "Paste"

Paste the contents of the clipboard into the program.

Operations with blocks "Copy to program"

Save the selected texts as an independent program. When selecting this option, the CNC shows a list of the available programs. To save the text as a program:

- 1 Select the destination folder.
- 2 Define the file name at the bottom window. To replace an existing file, select it from the list.
- 3 Press [ENTER] to save the program or [ESC] to cancel the selection and close the program listing.

18.

PLC

Editing in C language or mnemonic language.



CNC 8060
CNC 8065

(REF: 1402)

18.4.5 Softkey "Find/Replace".

This softkey is used to find a line or a text in the program and replace a text with another one. When selecting this option, the CNC shows a dialog box requesting the line number or the text to look for. When defining a text search, certain options may also be defining that allow:

- A Go to a line of the program.
- B Replacing the text being searched with another in the program.
- C Ignore uppercase and lowercase.
- D Consider the text to find as a whole word.
- E Select whether the search starts at the beginning of the program or at the cursor position.
- F Direction of the search.

After defining the search options, press [ENTER] to start the search or [ESC] to cancel it. The text found in the program will be highlighted and the softkey menu will show the following options:

- "Replace" option, to replace the highlighted text.
- "Replace all" option, to replace the text throughout the whole program.
- "Find next" option, to skip this text and keep on searching.
- "Find previous" option, to look for the text without replacing it.

To end the search, press [ESC].

18.4.6 Softkey "Customize".

This softkey is used for personalizing (customizing) the behavior, properties and appearance of the PLC editor.

Customizing the general options of the editor.

Option.	Meaning.
Save always.	Activating the automatic saving of the program. When this option is active, the CNC will automatically save the program every time the cursor changes blocks. In large programs (more than 200 kB), the CNC saves the program when the user has not modified the program for about 5 seconds. If this option is not active, the program is saved from the softkey menu. See " 18.4.2 Softkey "File" ." on page 291.
Line adjust.	Adjust the lines to the size of the window.
Show the line number.	Show the line numbers at the editor.
Drop menus.	Organize the horizontal softkey menu in drop menus.

Customize the appearance of the editor.

This option customizes the appearance (color, font, etc.) of the elements that make up the program editor. After defining the new look, press [ENTER] to accept the changes or [ESC] to ignore them.

Customize the syntax coloring.

This option may be used to customize the color of the elements that make up the program. After defining the new look, press [ENTER] to accept the changes or [ESC] to ignore them. In large programs (more than 200 kB), the editor cancels the syntax coloring.

18.

PLC
Editing in C language or mnemonic language.



CNC 8060
CNC 8065

(REF: 1402)

18.5 Editing in contact (ladder) language (softkeys).

Horizontal softkey menu.

Softkey.	Description.
Analyze.	Analyze the program searching for errors.
File.	Restore, import or export a file.
Editing.	Edit the selected program and copy, cut and paste a block or group of blocks.
View.	Enlarge or reduce the size of the contacts and of the text.
Marks.	Add or remove follow-up marks in the program.
Find.	Find a text or a block by its number.
Customizing.	Set the properties and appearance of the PLC editor.

Hotkey menu.

The following softkeys may be useful when editing.

Hotkey.	Function.
[+] [-]	Window zoom.
[CTRL][+] [CTRL][-]	Cell zoom.
[ENTER]	It edits the element on which the cursor is located. If the cursor is on the left column, it will show the dialog for editing the block comment.
[←] [→] [↑] [↓]	It moves the cursor in all 4 directions.
[SHIFT][←] [SHIFT][→] [SHIFT][↑] [SHIFT][↓]	It changes the selection.

18.

PLC
Editing in contact (ladder) language (softkeys).

FAGOR 

CNC 8060
CNC 8065

(REF: 1402)

18.5.1 Softkey "Analyze".

This softkey analyzes the program searching for errors. The errors found will be displayed in the "Outputs" service window.



To close this window and return to the editor, press [ESC]. To return to the editor without closing the window, press the [NEXT] key.

18.

PLC

Editing in contact (ladder) language (softkeys).

18.5.2 Softkey "File".



This softkey is used to restore, import or export a file. When selecting this option, the softkey menu shows the available options. To return to the main menu, press the [BACK] key.

File "Save"

This softkey saves the file that is being edited.

File "Save as"

This softkey saves the file, that is being edited, with a different name. After saving the file, one keeps editing the new file.

Softkey "Import file"

This softkey imports the translation of a program edited in mnemonic language into the program that is now being edited. This softkey is useful for converting a mnemonic-language file into a contact (ladder)-language file without having to compile the PLC project.

The following expressions in mnemonic language cannot be translated directly into contact (ladder) language and the CNC will translate them as follows.

- Expressions with the XOR operator.
- Expressions where the NOT operator affects several contacts.

Original expression.	Transformed expression.
a XOR b	(a OR b) AND (NOT a OR NOT b)
NOT (a AND b)	(NOT a OR NOT b)
NOT (a OR b)	(NOT a AND NOT b)

File "Export file"

This softkey exports to a file the translation into mnemonic language of the program that is now being edited.

18.5.3 "Edit" softkey.



This softkey may be used to edit the selected program and copy, cut and paste a block or group of blocks. When selecting this option, the softkey menu shows the available options. To return to the main menu, press the [BACK] key.

Edit "New block".

This softkey adds a new block with an empty contact. This contact will be the action for a consultation and "n" the number identifying the block. The new block is inserted above the block where the cursor is located.

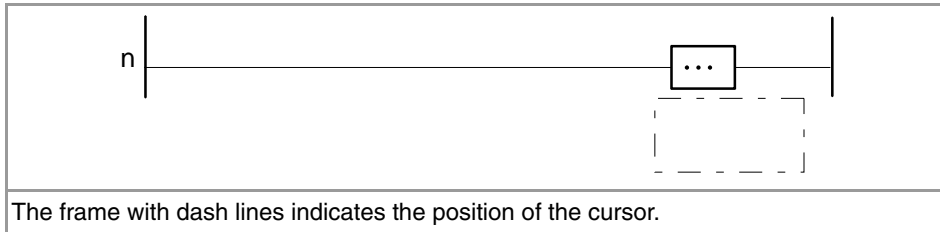

Positioning the cursor on the action_contact and pressing [ENTER] displays a dialog box for associating an instruction and a comment with it. The "Expected" field offers a context help with valid instructions.

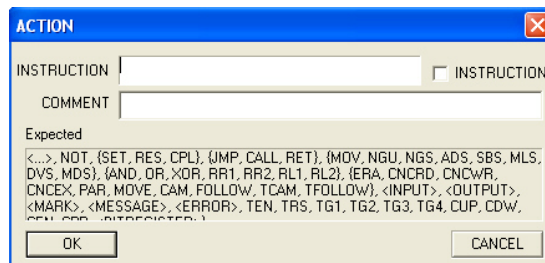

The instruction must be written in mnemonic language. Placing the cursor on action_contact and using the "Parallel" softkey, it is possible to add other action_contact in parallel.

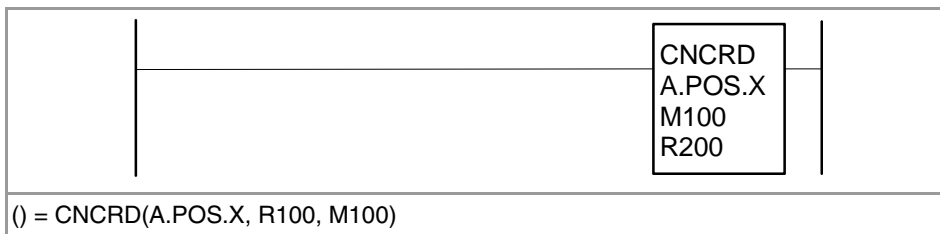

To define a directing instruction, activate the "Directing" field in the dialog box and then write an instruction. Directing instructions can only be programmed in a block with their action_contact empty and without consultation_contact.



Edit "Cut"

Cut the selected contact or block.

Edit "Copy"

Copy the selected contacts or blocks.

Edit "Paste"

Paste the contacts or blocks that have been previously cut or copied. It pastes them in parallel with the selection.

Edit "Delete"

Delete the selected contacts or blocks.

18.

PLC Editing in contact (ladder) language (softkeys).



CNC 8060
CNC 8065

(REF: 1402)

Edit "Undo"

This softkey may be used to "undo" the last modifications made. The modifications are undone one by one starting from the most recent one.

Edit "Redo"

This softkey is active after using "Undo" and restores one by one the previous status of the program, before "Undo" was used.

Edit "Left series"

This softkey adds a consultation_contact to the left of the contact selected with the cursor.

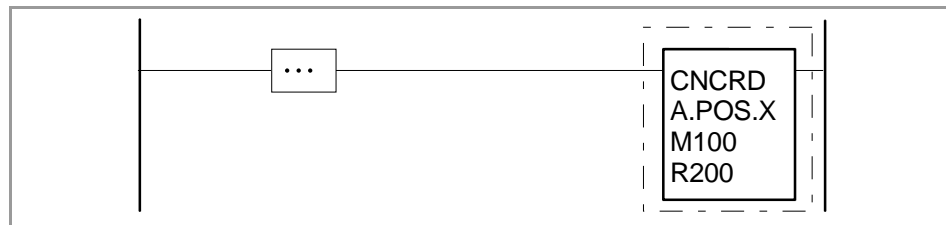

Positioning the cursor on the consultation_contact and pressing [ENTER] displays a dialog box for associating an instruction and a comment with it. The "Expected" field offers a context help with valid instructions.

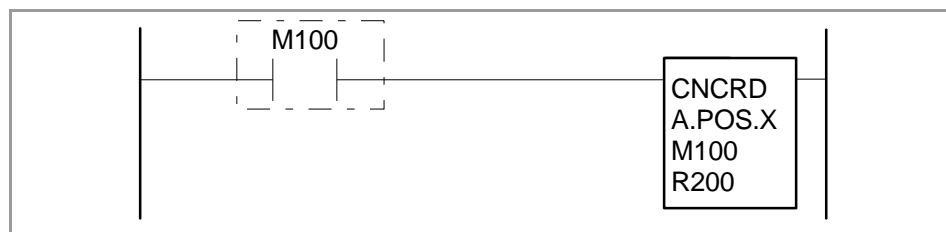

For example, the user can make it to be a contact for comparing two registers with the instruction "CPS R1 EQ R2" or a simple contact of the mark "M100"

In mnemonics, it is the same as M100 = CNCRD(A.POS.X, R100, M100)

Edit "Right series"

This softkey adds a consultation_contact to the right of the contact selected with the cursor.

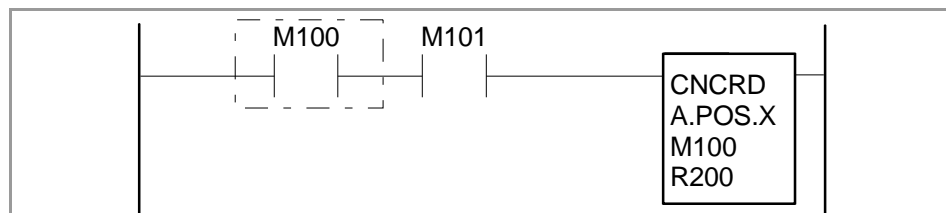

M100 AND M101 = CNCRD(A.POS.X, R100, M100)

Edit "Parallel"

This softkey adds a consultation_contact in parallel to the contact selected with the cursor.

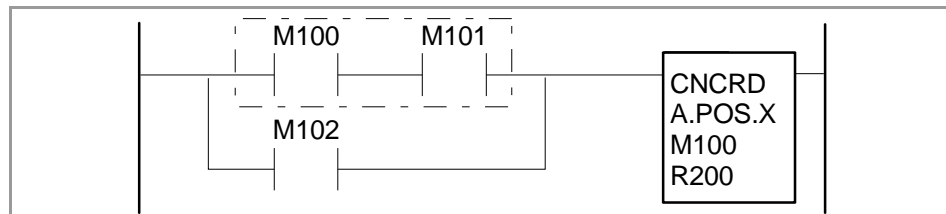

(M100 AND M101) OR M102 = CNCRD(A.POS.X, R100, M100)

18.

PLC
Editing in contact (ladder) language (softkeys).



CNC 8060
CNC 8065

(REF: 1402)

Edit "Negate"

This softkey negates the consultation_contact selected with the cursor.

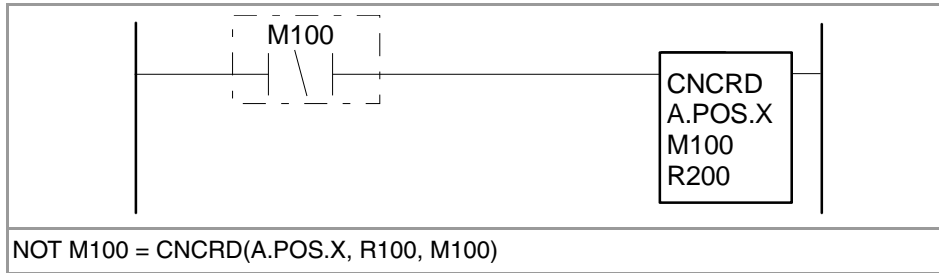
**18.**

PLC
Editing in contact (ladder) language (softkeys).

18.5.4 Softkey "View".

This softkey may be used to enlarge or reduce the size of the contacts and of the text. When selecting this option, the softkey menu shows the available options. To return to the main menu, press the [BACK] key.

View "Zoom +"

Increase the size of the font as well as the height and width of the contacts.

View "Zoom -"

Reduce the size of the font as well as the height and width of the contacts.

View "Cell +"

Increases the width of the contacts.

View "Cell -"

Reduce the width of the contacts.

18.5.5 Softkey "Marks".

This softkey may be used to add or remove follow-up marks in the program. When selecting this option, the softkey menu shows the available options. To return to the main menu, press the [BACK] key.

Marks "Set / remove"

Place a mark or remove the mark of the block where the cursor is located.

Marks "Next mark"

Place the cursor on the next marked block.

Marks "Previous mark"

Place the cursor on the previous marked block.

Marks "Remove all"

Remove all the marks.

18.5.6 Softkey "Find".

This softkey is used to find a text or a block by its number.

Find "Find"

When selecting this option, the CNC shows a dialog box requesting the block number or the text to look for. When defining a text search, certain options may also be defining that allow:

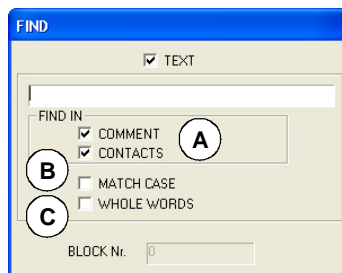

- A Select the types of fields in which to search.
- B Ignore uppercase and lowercase.
- C Consider the text to find as a whole word.

After defining the search options, press [ENTER] to do the search or [ESC] to cancel it. Pressing [ENTER] positions the cursor in the first field that matches the search parameters.

Find "Find next"

It positions the cursor in the next field that matches the search parameters.

Find "Find previous"

It positions the cursor in the previous field that matches the search parameters.

18.5.7 Softkey "Customize".

It is used for personalizing the appearance (color, font, etc.) and properties of the editing window.

After defining the new look, use the cursor to select one of the buttons here below to accept or ignore the changes made and press [ENTER]. The dialog box may also be closed directly without accepting the changes by pressing [ESC].

18.

PLC

Editing in contact (ladder) language (softkeys).

18.6 Program monitoring

To monitor a program, select it from the list of the service window and select the "Monitoring" option of the softkey menu. The CNC will display the monitoring window and it will show the instructions of the selected program. To close the monitoring window, press [ESC].

Description of the monitoring window

The editing window shows the following information:

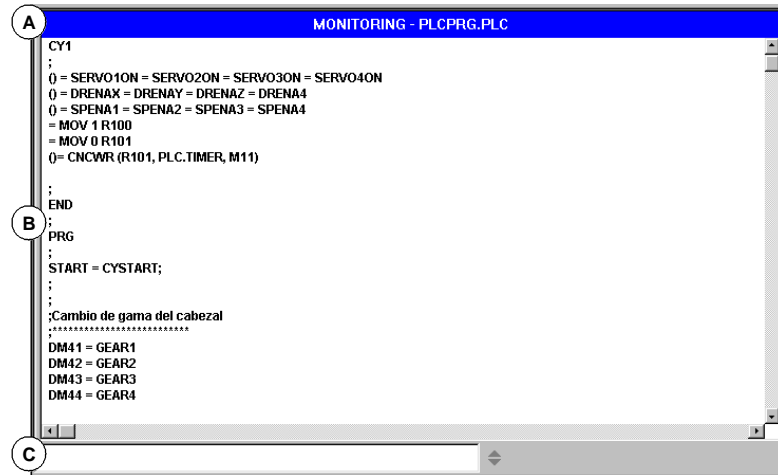

- A** Title bar. It shows the name of the program that is being monitored.
- B** Monitoring area. It shows the status of the instructions being executed. It is a real-time monitoring. Only the instructions that are being executed are monitored.

The PLC will show, in a different color, the instructions that are not being executed such as the first cycle or those subroutines whose call is not active. The default colors are:

- Red Active variables.
- Green Instruction that is not being executed.
- Black Inactive variable or comment.

- C** In a program edited in C language or in mnemonic language, it is the data entry zone. This zone is used to modify the values of the PLC resources.

In a program edited in contact (ladder) language, it is the zone that shows the comments of a contact and other messages. In the "Monitoring" service, it is not possible to change the names or comments associated with the contacts.

18.

PLC
Program monitoring

FAGOR 

CNC 8060
CNC 8065

(REF: 1402)

18.6.1 Softkey menus. Monitoring in C language or mnemonic language.



This softkey toggles the display between the mnemonic language and the contact language (ladder diagram). The softkeys of the horizontal menu change according to the selected language.

In a program edited in C language or in mnemonic language, the softkey menu shows the following options.

Monitoring "Size +"

Every time this softkey is pressed, the size of the text will increase.

Monitoring "Size -"

Every time this softkey is pressed, the size of the text will decrease.

Monitoring "Bold"

When selecting this option, the text of the program appears in bold.

Monitoring "Find"

This softkey is used to find text in the program. When selecting this option, the CNC shows a dialog box requesting the text to be found. Key in the text and press [ENTER] to begin the search.

As the text is being searched, the cursor will position on the match found. To end the search, press [ESC].

Monitoring "Customize"

It is used to personalize certain functions of the monitoring window. When selecting this option, the CNC shows a dialog box with the options available for customizing.

18.

PLC
Program monitoring



CNC 8060
CNC 8065

(REF: 1402)

18.6.2 Softkey menus. Monitoring in contact (ladder) language.



This softkey toggles the display between the mnemonic language and the contact language (ladder diagram). The softkeys of the horizontal menu change according to the selected language.

In a program edited in contact (ladder) language, the softkey menu shows the following options.

View.



This softkey may be used to enlarge or reduce the size of the contacts and of the text. When selecting this option, the softkey menu shows the available options. To return to the main menu, press the key for the previous menu.

View "Zoom +"

Increase the size of the font as well as the height and width of the contacts.

View "Zoom -"

Reduce the size of the font as well as the height and width of the contacts.

View "Cell +"

Increases the width of the contacts.

View "Cell -"

Reduce the width of the contacts.

Marks.



This softkey may be used to add or remove follow-up marks in the program. When selecting this option, the softkey menu shows the available options. To return to the main menu, press the key for the previous menu.

Marks "Set / remove"

Place or remove a mark on the block where the cursor is located.

Marks "Next mark"

Place the cursor on the next marked block.

Marks "Previous mark"

Place the cursor on the previous marked block.

Marks "Remove all"

Remove all the marks.

Find

This softkey is used to find a text or a block by its number.

Find "Find"

When selecting this option, the CNC shows a dialog box requesting the block number or the text to look for.

Find "Find next"

This option positions the cursor in the next field that matches the search parameters.

Find "Find previous"

This option positions the cursor in the previous field that matches the search parameters.

Customizing

This softkey is used for personalizing the appearance and properties of the editing window. When selecting this option, the CNC displays a dialog box showing the elements that may be set.

Activate

This softkey is used to turn monitoring on or off. The program is not monitored until the "Activate" option is pressed.

18.**PLC**
Program monitoring

CNC 8060
CNC 8065

(REF: 1402)

18.7 "Commands" service

The "Commands" service is used to debug the PLC program execution by taking advantage of the possibility to execute the various parts of the program separately (first cycle, main module and periodic module). This service also offers the possibility of starting up and interrupting the execution of the PLC program.

When selecting this service, the horizontal softkey menu offers all the options associated with this service.

18.7.1 Softkey menus. Options of the "Commands" service.

Commands "Run"

This softkey is used to start the execution of the PLC program. The PLC executes the first cycle (CY1) once and continues with the cyclic execution of the main program (PRG) and the periodic module (PE). The main program is executed according to the frequency defined by machine parameter. The periodic module is executed according to the frequency defined in the program.

Commands "Stop"

This softkey is used to stop the execution of the PLC program.

Commands "CY1"

This softkey is used to execute the part of the program corresponding to the first cycle (CY1). The CNC does not execute this option when the PLC program is running.

Commands "Cycle"

This softkey is used to execute the main program (PRG) once. The CNC does not execute this option when the PLC program is running.

Commands "Resume"

This softkey is used to resume the cyclic execution of the PLC program. The CNC does not execute this option when the PLC program is running.

Commands "PE module"

This softkey is used to execute the periodic module (PE) once. The CNC does not execute this option when the PLC program is running.

18.PLC
"Commands" service**FAGOR** CNC 8060
CNC 8065

(REF: 1402)

18.8 "Outputs" service

The "Outputs" service shows the following information:

- The result of generating (compiling) the PLC program.
- The result of analyzing a file of mnemonics.
- The result of text search in the files making up the PLC project.

Pressing the "Show" softkey accesses the screen of this service that shows this information. To close the window, press [ESC].

18.

PLC
"Outputs" service

Description of the outputs service

The screen of this service looks like this:

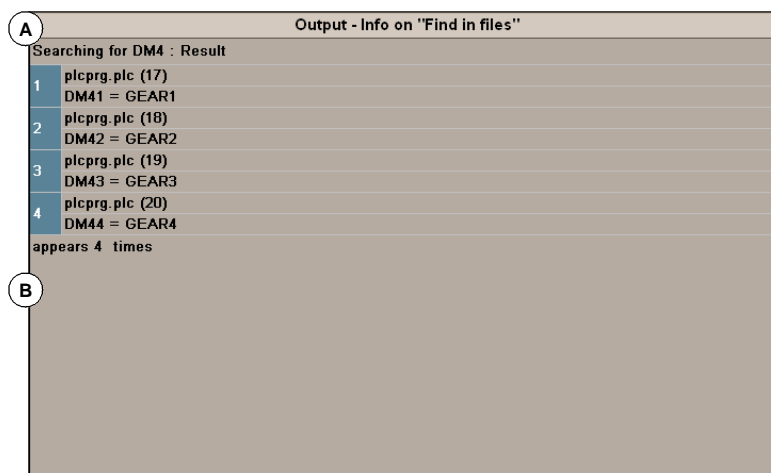

A Title bar.

It shows the type of information displayed in the window (information about the compilation, file analysis or a search).

B Requested information.

It shows the requested information.

18.8.1 Softkey menus. Options of the "Outputs" service.

When accessing the "Outputs" service, the softkeys will show the following option.

Outputs "Compiling info"



This softkey shows the result of compiling (generating) the PLC program. The screen shows a list of warning or errors detected when compiling the PLC program. After selecting a warning or error from the list, it is possible to go to the erroneous line by pressing the relevant icon.

Outputs "Checking info"

This softkey shows the result of analyzing the file of mnemonics. The screen shows a list of the error detected when analyzing the program. After selecting a warning or error from the list, it is possible to go to the erroneous line by pressing the relevant icon.

Outputs "Search info"

This softkey shows the result of searching text in the programs making up the PLC project. After selecting an element from the list, it is possible to go to its line by pressing the relevant icon.

18.PLC
"Outputs" service**FAGOR** CNC 8060
CNC 8065

(REF: 1402)

18.9 "Logic analyzer" service

The "Logic analyzer" service is used to analyze the behavior of the logic PLC signals according to a time base and certain trigger conditions set by the user.

Up to 8 PLC variables or expressions may be analyzed at the same time and the result of the analysis (the traces) will appear on a graphic interface that facilitates the interpretation of the data. Once the done capturing data, the user may:

- Modify the time base to display different zooms of the traces.
- Move along the traces to display points, times, time differences, etc.

To close the window, press [ESC].

Description of the logic analyzer

The logic analyzer looks like this:

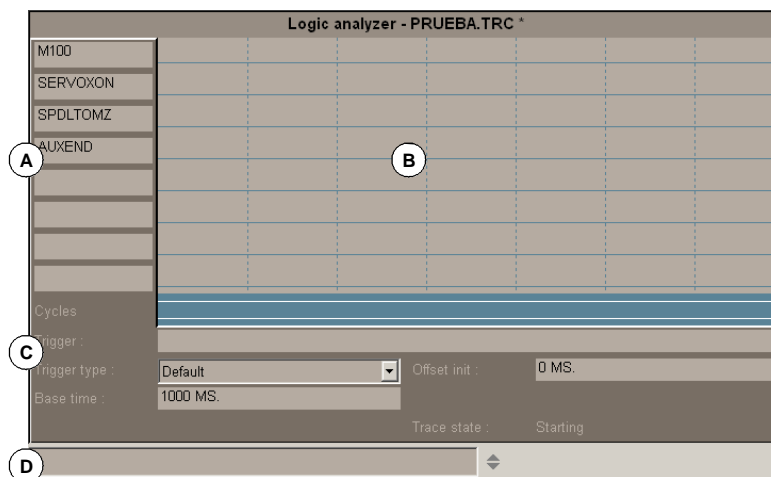





- A** The data area is used to define the variables or expressions to be analyzed. Up to 8 PLC variables or expressions may be defined.
- B** The graphic area shows the traces for the defined PLC variables or expressions and a trace of the PLC cycles with the indicated conditions.
- Also, a vertical red line is displayed to indicate the trigger point (if any) and a green line to indicate the cursor position.
- C** The information area is used to define the data that conditions the display of the traces (trigger, type of trigger, time base and trace status).
- D** The data entry area is used to modify the PLC resources.

Softkey menus

When selecting the logic analyzer, the horizontal softkey menu offers all the options associated with this service. The set of options offered by this menu may be changed using the "+" softkey which offers a new set of options.

18.9.1 Editing logic analyzer data

In order to capture trace data, the user must enter the variables or expressions to be analyzed, the trigger type and conditions as well as the time based to be used to display the captured values. To edit this data, select the graphic area of the logic analyzer and press the "Edit view" softkey to place the cursor on the data editing area.

Key.	Meaning.
	Move the cursor through the data.
	Move the cursor within a data.
	Open/close pop-up menus.
	Validate the defined data.
	Cancel edit.

Definition of variables

Up to 8 PLC variables or expressions may be defined to obtain their trace. The definition of the expression cannot exceed 80 characters.

When modifying a variable, if there was already a trace of that expression, the trace will be deleted when validating the new edition.

Trigger condition

A trigger condition is the one used to capture data and may be defined with a PLC variable or expression. The definition of the expression cannot exceed 80 characters.

If the trigger condition is modified after a data capture, all the traces will be deleted when validating the new condition.

Trigger type

It sets whether the data is to be captured "before", "after" or "before and after" the selected trigger condition is met.

- By default The data capture starts and ends when the operator selects the option to execute and stop the trace.
- Before The data capture starts when the trigger condition is met and ends when the operator selects the option to stop the trace.
Once the trace has been executed, the trigger signal will be shown at the beginning of the trace.
- After The data capture starts when the operator selects the option to execute the trace and ends when the trigger condition is met.
Once the trace has been executed, the trigger signal will appear at the end of the trace.
- In the middle The data capture starts and ends when the operator selects the option to execute and stop the trace.
Once the trace has been executed, the trigger signal will be shown at the center of the trace.

Time base

The operator may use this parameter to assign the timeframe to each vertical division. The size of these divisions, therefore the resolution of these signals will be determined by this time base. Consequently, the smaller the time base, the greater the signal resolution.

The value is given in milliseconds or microseconds according to the active units and the selected value will be displayed in the information area.

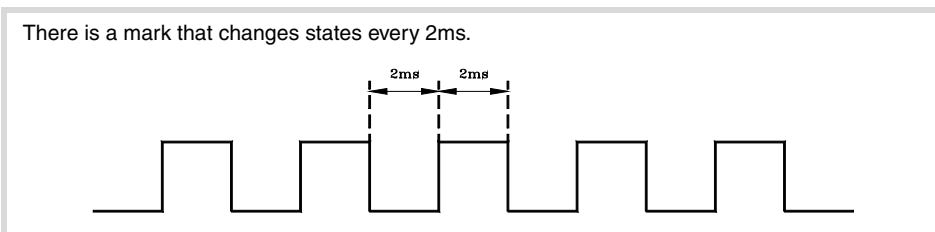

With a time base of 10ms, 20ms and 4ms it will look like this.

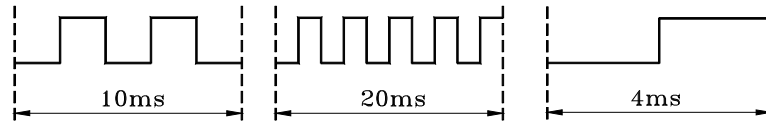

While the graphic window is selected, use the "+" and "-" keys to divide or multiply this time base by two.

Start distance / Trigger distance

This data is only shown when there is a trace.

Start distance	It represents the time difference between the indicator cursor and the base point of the trace (beginning of the trace if there is no trigger point or it has not been reached).
Trigger distance	It represents the time difference between the indicator cursor and the trigger point (if it has taken place).

The value is updated when moving the indicator cursor of the graphic area. Its value may also be edited, thus updating the cursor position in the graphic area.

Reference distance

This data is only shown when there is a trace already and the operator has put a reference signal. It represents the time difference between the indicator cursor and the reference signal.

The value is updated when moving the indicator cursor of the graphic area. Its value may also be edited, thus updating the cursor position in the graphic area.

Trace status

This element cannot be edited, it automatically reflects the status of the trace. The possible messages are:

- Empty.
- Beginning.
- Executing.
- Stopping.
- Full.

18.

PLC
"Logic analyzer" service



CNC 8060
CNC 8065

(REF: 1402)

18.9.2 Save, load and reset the analyzer configuration

Save the configuration

This option is used to save the current configuration of the logic analyzer (PLC variables and expressions, trigger conditions, graphic traces) into a file. When selecting this option, the CNC shows a list of trace files (TRC) already saved. To save the current configuration:

- 1 Define the file name at the bottom window. To replace an existing file, select it from the list.
- 2 Press [ENTER] to save the configuration or [ESC] to return to the logic analyzer without saving the configuration.

Load the configuration

This option is used to recover a logic analyzer configuration that has been stored earlier. When selecting this option, the CNC shows a list of trace files (TRC) already saved. To load one of these files:

- 1 Define the file name at the bottom window or select it from the list.
- 2 Press [ENTER] to save the configuration or [ESC] to return to the logic analyzer without loading the configuration.

Initialize the configuration

This option is used to reset all the analyzer data eliminating the defined variables or expressions as well as the trigger condition and trigger type. The traces are also deleted because there are no variables to be analyzed.

18.PLC
"Logic analyzer" service**FAGOR** CNC 8060
CNC 8065

(REF: 1402)

18.9.3 Execute and analyze trace

Execute trace / Stop trace

This softkey is used to start or stop the data capture to display the traces.

Analyze trace



This softkey is used to analyze the different graphic aspects of the trace. When selecting this option, the softkey menu shows the options available for analyzing the trace. To return to the main menu, press the [BACK] key.

- Go to the beginning
It moves the indicator cursor and the current graphic view to the beginning of the trace.
- Go to the end
It moves the indicator cursor and the current graphic view to the end of the trace.
- Go to the time
It moves the indicator cursor and the current graphic view to the time value set by the operator with respect to the base point of the trace (starting point of the trace if there is no trigger or to the trigger point if there is one).
- Go to trigger
It moves the indicator cursor and the current graphic view to the trigger point.
- Go to reference
It moves the indicator cursor and the current graphic view to the reference point defined earlier.
- Set reference
It sets a reference point at the current cursor position for time difference calculation.
- Remove reference
Removes the reference point defined earlier.

Trace view / Edit view

This softkey toggles between the graphic window and the data and display conditions area.

MS (milliseconds) / US (microseconds)

This softkey toggles between milliseconds and microseconds.

Print

This softkey may be used to print the graphics in a printer connected to the CNC or as a file (*.BMP format) at the CNC. When printing to a file, it is saved in the folder:

"C:\Cnc8070\Mtb\Plc\Watch*.bmp"

18.9.4 Customize the appearance of the logic analyzer

It is used to customize the looks of the different elements of the logic analyzer. When selecting this option, the CNC shows a dialog box with the options available for customizing.

18.

PLC
"Logic analyzer" service



CNC 8060
CNC 8065

(REF: 1402)

18.10 "Monitoring" service

This service is used to analyze the status of the various PLC variables and resources. When selecting the "Monitoring" option at the service window, it will show a list with the three resource files used last. This will let you recover one of them without having to define it again.

Pressing the "Show" softkey access the service screen. If a file was selected from the list, it will show the resources defined in it. To close the monitoring window, press [ESC].

Description of the monitoring service

This service screen is divided into several windows that may be accessed with the window switching key. The monitoring screen looks like this:

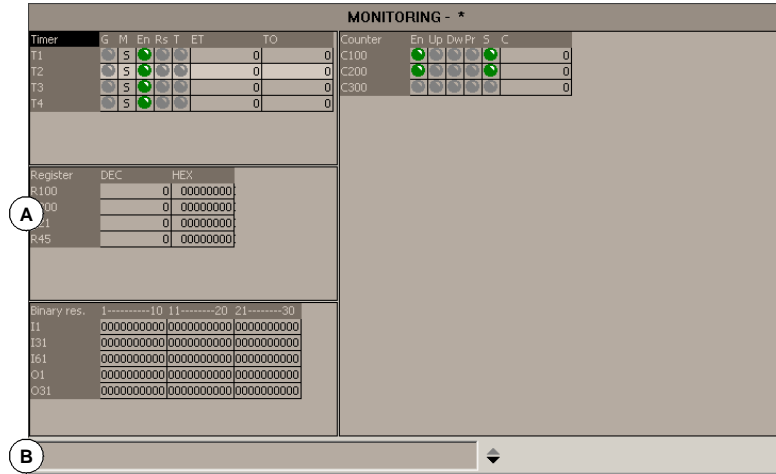

A Resources selected for monitoring. This area shows the user resources and symbols being analyzed. The resources and symbols are shown grouped in the following tables, each of them shows information on the status of those resources.

- | | |
|-----------|------------------|
| Timers | Counters |
| Registers | Binary resources |

B Data entry area. This area is used to define the user resources and symbols to be analyzed and modify their values by directly assigning a value to them.

Softkey menus

When selecting this service, the horizontal softkey menu will show all the options associated with resource monitoring. The set of options offered by this menu may be changed using the "+" softkey which offers a new set of options.

18.

PLC
"Monitoring" service

18.10.1 Description of resource tables

As mentioned earlier, the user resources and symbols defined are displayed in different tables. Each table shows the following information.

Timers

This table shows the timers and user defined symbols for the timers and their status. This table has the following fields:

Field.	Meaning.
G	It indicates whether any of the trigger inputs of the timer is active (TG1, TG2, TG3 or TG4).
M	Timer status: (S) Stopped / (T) Timing / (D) Disabled.
E	Status of the Enable input (TEN).
R	Status of the Reset input (TRS)
T	Status output.
ET	Elapsed time.
TO	Remaining time.

The inputs and outputs that are high will be indicated with a green symbol.

Registers

This table shows the registers and user symbols defined for the registers as well as their values.

The values may be shown in decimal, hexadecimal or binary format.

Binary resources

This table shows the binary resources (inputs, outputs, messages, errors) and the user defined symbols for the binary resources as well as information on the their status.

Counters

This table shows the counters and user symbols defined for the counters as well as their status. This table has the following fields:

Field.	Meaning.
E	Status of the enable input (CEN).
U	Status of the Count-up input (CUP).
D	Status of the Countdown input (CDW).
P	Status of the preset input (CPR).
S	Status output.
C	Value of the internal count of the counter.

The inputs and outputs that are high will be indicated with a green symbol.

18.10.2 Definition of the table resources

Each table shows the following resources and user symbols:

Timer table

- Timers (T1...T512).
- User symbols defined for the timers.

Counter table

- Counters (C1...C256).
- User symbols defined for the counters.

Register table

- Registers (R1...R1024).
- User symbols defined for the registers.
- PLC-CNC register variables.

Binary resource table





- Inputs (I1...I1024) and outputs (O1...O1024).
- Marks (M1...M8192).
- Messages (MSG1...MSG1024) and errors (ERR1...ERR1024).
- User symbols defined for the binary resources.
- CNC-PLC boolean variables.

When defining a resource or user symbol, it will be added to the corresponding table.





Data entry

The resources and user symbols of the tables are defined at the data entry area. Their values may be changed by directly assigning a value to them (M110=1, R300=34). If it is a hexadecimal value, it must be preceded by the "\$" sign (M10=\$1, R200=\$20).

The window saves the last "N" assignments so they can be recalled later on. In order to make selecting easier, it is possible to display a window with the list of the assignments already made.

Key.	Meaning.
	Move the cursor through the list of expressions.
	Select an expression from the list.
	Show the list of expressions.
	Close the list of expressions.

To remove a resource or user symbol from a table, select that element and press [SUP].

Key.	Meaning.
	Select a table.
	Move the cursor.
	Move the cursor page by page.
	Move the cursor to the beginning / end of the table.
	Delete the selected resource from the table.

18.10.3 Options of the "Monitoring" service (softkeys).

When accessing the "Monitoring" option of the softkey menu, the following options will be available.

Save set

This softkey is used to save the set of defined resources into a file. When selecting this option, the CNC displays a window with the list of the files (.MON) currently saved. To save a set of defined resources:

- 1 Define the file name at the bottom window. To replace an existing one, select it from the list.
- 2 Press [ENTER] to save the program or [ESC] to cancel the selection and close the program listing.

Load set

This softkey is used to recover the set of resources previously saved into a file. When selecting this option, the CNC shows a window with the list of available files. To load one of these files:

- 1 Define the file name at the bottom window or select it from the list.
- 2 Press [ENTER] to load the selected file or [ESC] to cancel the operation and close the program listing.

Binary

This softkey toggles between displaying the register values in decimal and hexadecimal format or only in binary.

Visibility

This softkey shows or hides certain resource tables.

Add row

This softkey increases the size of the active window (where the cursor is) by adding a row to it.

Remove row

This softkey decreases the size of the active window (where the cursor is) by removing a row from it.

Data input

This softkey selects the data entry area.

Clear all

Delete all the resources from the tables.

18.

PLC
"Monitoring" service



CNC 8060
CNC 8065

(REF: 1402)

18.11 "Cross references" service

The "Cross references" service may be used to obtain information about the PLC resources being used in the PLC project. Pressing the "Show" softkey accesses the window of this service. To close the cross-reference window, press [ESC].

Description

The screen of this service looks like this:

Cross references - Marks			
Name	File	Line	Use
AUXEND	plcprg.plc	31	=
AUXENDC2	plcprg.plc	32	=
AUXENDC3	plcprg.plc	33	=
AUXENDC4	plcprg.plc	34	=
CYSTARTC1	plcprg.plc	10	=
CYSTARTC2	plcprg.plc	11	=
CYSTARTC3	plcprg.plc	12	=
CYSTARTC4	plcprg.plc	13	=
DM41	plcprg.plc	17	?
DM42	plcprg.plc	18	?

- A** Name of the resources being used by the PLC project.
- B** File of the PLC project where the resource is being used.
- C** Line, within the file, containing the resource.
- D** How the resource is being used.

For the inputs, outputs, marks and registers:

? The resource is used as a consultation.

= The resource is used as an action.

For the timers.

TG Timer trigger.

T Status consultation.

TEN Enable input.

TRS Reset input.

For the counters.

C Status consultation.

CPR Counter preset.

CEN Enable input.

CUP Count-up input.

CDW Countdown input.

18.

PLC
"Cross references" service

FAGOR 

CNC 8060
CNC 8065

(REF: 1402)

18.11.1 Softkey menus. Options of the "Cross reference" service.

When accessing the "Cross reference" service, the softkey menu will offer the following options:

Inputs

Show information about the inputs.

Outputs

Show information about the outputs.

Marks

Show information about the marks.

Registers

Show information about the registers.

Timers

Show information about the timers.

Counters

Show information about the counters.

Print

It is used to print the cross reference tables out to a printer connected to the CNC or as a "*.PRN" file at the CNC. When printing to a file, it is saved in the folder:

"C:\Cnc8070\Users\Reports*.prn"

When selecting this option, the CNC shows a dialog box requesting the destination for the file (printer or file). When printing to a file, it is possible to select the name and location of the file. After selecting the destination, press [ENTER] to print the table or [ESC] to cancel it.

18.

PLC
"Cross references" service



CNC 8060
CNC 8065

(REF: 1402)

18.12 "Statistics" service

The "Statistics" service may be used to obtain information about the execution times of the PLC and the files making up the PLC project. Pressing the "Show" softkey access the service screen. To close the statistics screen, press [ESC].

Description

The screen of this service looks like this:

Statistics				
Times	Minimum	Maximum	Average	Frequency
CY1	---	---	0 us	---
PRG	0 us	1000000 us	21 us	8000 us
PE	---	---	---	---
LC Process	0 us	1000000 us	21 us	4000 us

Files	Size	Type	Modified
PLCPRG.PLC	1 KB	IL source file	21/01/2010 14:16:40

A Execution time-table.

This table shows the following data (from left to right):

- Modules making up the PLC program.
- Minimum module execution time.
- Maximum module execution time.
- Average module execution time.
- Module execution frequency.

B PLC file table.



This table shows the following data (from left to right):

- Files making up the PLC project.
- Size of each file.
- File type.
- Date last modified.

18.

PLC
"Statistics" service

18.12.1 Softkey menus. Options of the "Statistics" service.

Softkey.	Description.
	This softkey refreshes the table information.
	This softkey may be used to print the table in the pre-determined printer or save it as a file (prn format) at the CNC. When selecting the "File" option, it will be saved in the folder "C:\Cnc8070\Users\Reports\". When selecting this option, the CNC will show a dialog box requesting the print destination (printer or file). After selecting the destination, press [ENTER] to print it or [ESC] to cancel it.

18.

PLC
"Statistics" serviceCNC 8060
CNC 8065

(REF: 1402)

18.13 "Messages" service

The "Messages" service may be used to edit the texts associated with PLC messages and errors. These files may also be displayed and edited (and thus translated into other languages) using any text editor.

The message and error files are stored in the folder: "C:\CNC8070\MTB\PLC\LANG\<language>" corresponding to the language active at the CNC. To use messages and errors in other languages, copy the files to the folder of the desired language. On CNC power-up, the messages and errors are loaded from the folder corresponding to the language active at the CNC.

Pressing the "Show" softkey access the service screen. To close the message window, press [ESC].

Description

This screen shows the messages (MSG) and errors (ERR) defined at the PLC. The screen shows the following table.

Messages and errors	
ERR1	ERROR-1-
ERR2	ERROR-2-
ERR3	ERROR-3-
ID	3
Show	<input type="checkbox"/>
Message	ERROR-3
Related file	C:\CNC8070\MTB\PLC\Lang\msg3.jpg
Emergen	<input checked="" type="checkbox"/>
MSG1	MSG-1-
MSG2	MSG-2-
MSG3	MSG-3-
MSG4	MSG-4-

A Message or error identifier.

Number, between 1 and 1024, that identifies the message (MSG) or the error (ERR). The numbering needs not be sequential; i.e. number skipping is allowed.







B Display of the additional information files. This field indicates whether to show or not the file for additional information when displaying the message or the error.

C Address of the additional data file which may be a text file (*.txt), image file (*.bmp, *.jpg), a combination of both (*.htm, *.html) or a video (*.avi).

D Activate the emergency signal (_EMERGEN) or not when activating the error. This field appears selected by default when editing a new error. When editing messages, this field does not appear because PLC messages do not activate the emergency signal.

E Text of the message or error displayed for the user.

18.13.1 Softkey menus. Options of the "Messages" service.

Softkey.	Description.
	Save the message and error table into a file in ASCII format (*.MEF).
	Recover the table values saved earlier in the hard disk of the CNC.
	Print the message and error table out to a printer connected to the CNC or as a file (*.PRN format) at the CNC.
	Define a new message in the table.
	Define a new error in the table.
	Select the file for additional information.
	Delete the selected message or error from the table.

18.

PLC

"Messages" service

18.13.2 Editing the message and error table

To add a new message or error to the table, press the "New message" or "New error" softkey. The CNC adds a new row to the table and it identifies it with the label -MSG- or -ERR-, indicating that it corresponds to a message or to an error. To delete a message or an error from the table, select it with the cursor and press the "Delete" softkey.

To edit or modify the table data, use the cursor to select the field whose value is to be changed and define the data as follows:

- The number and text of the message or error is entered directly from the keyboard.
- The "show" option is turned on and off with the [SPACE] key.
- The "EMERGEN" option is turned on and off with the [SPACE] key. This option only appears when editing errors.
- The file for additional information may be entered directly or may be selected with the "Associate file" softkey.

Press [ENTER] every time a data is edited to accept the new value or [ESC] to cancel it.

18.PLC
"Messages" service**FAGOR** CNC 8060
CNC 8065

(REF: 1402)

18.13.3 Displaying PLC messages

When activating a message (marks "MSG1" through "MSG1024"), the PLC message window (top right) shows the message number and its associated text. If the message has been defined so it shows a file with additional information, it will be displayed at full screen (if the file does not exist, a blue screen will be displayed).

If there are several active messages, it will display the one with highest priority (the one with lowest number). It will also show the "+" sign next to the PLC message window to indicate that there are more messages activated by the PLC.

Message window

In order to expand the PLC message window and display the active message list, press the key combination [CTRL]+[M]. The list will show a symbol next to each message to indicate that it has a file with additional information associated with it.



It does not have a file with additional information.





It has a file with additional information.

To display a message, select it with the cursor and press [ENTER]. If the message has an additional information file, it will be displayed on the screen. To close the additional information window, press [ESC].





File with additional information

The files with additional information, defined by the machine manufacturer, may be displayed automatically when activating the message (if so defined in the table for messages and errors) or when requested by the user (at the message window). The following keys are available to move around in the additional information window depending on the type of file displayed (TXT, BMP, JPG, HTM, HTML or AVI):

TXT, BMP, JPG, HTM, HTML file.

Key.	Meaning.
	Scroll the window line by line.
	Scroll the window page by page.
	Take the window to the beginning or to the end.

AVI file.

Key.	Meaning.
	Stop the video and move to next frame or previous frame.
	Stop the video and move to the next 5 frames or to the previous 5 frames.
	Stop the video and move to the end or to the beginning.
	Stop the video.
	Play the video.

18.13.4 Displaying PLC errors

When activating an error (marks "ERR1" through "ERR1024"), part-program execution is interrupted and the center of the screen displays a window with the error number and its associated text. If the error has been defined so it shows a file with additional information, it will be displayed at full screen. If the error has the "Emergen" field selected, the error will open the emergency relay of the CNC.

Error window.



If the error has a file with additional information associated with it, an access icon will appear to the right of the error number. If the error has the "Show" field selected, the CNC shows the additional information file directly on the screen. If the "Show" field is not selected, the additional information file will be displayed when pressing the [HELP] key or when clicking on the icon mentioned earlier. To close the additional data window, press [ESC].

When there is an active error, no other action but eliminating the error state is allowed. Although the window displaying the errors may be closed by pressing [ESC], it does not mean that the error status has been taken care of. To do that, press [RESET]. Pressing the [RESET] key assumes the initial conditions.

File with additional information

The files with additional information, defined by the machine manufacturer, may be displayed automatically when activating the message (if so defined in the table for messages and errors) or when requested by the user (at the message window). The following keys are available to move around in the additional information window depending on the type of file displayed (TXT, BMP, JPG, HTM, HTML or AVI):

TXT, BMP, JPG, HTM, HTML file.

Key.	Meaning.
	Scroll the window line by line.
	Scroll the window page by page.
	Take the window to the beginning or to the end.

AVI file.

Key.	Meaning.
	Stop the video and move to next frame or previous frame.
	Stop the video and move to the next 5 frames or to the previous 5 frames.
	Stop the video and move to the end or to the beginning.
	Stop the video.
	Play the video.

18.13.5 Grouping the additional information text files in a single file.

PLC messages and errors can show an additional information file in text format. The PLC allows grouping several or all these files into a single file as follows.

Defining the additional information file.

It must be a text file (extension txt) and may have any name. The information of each message and error must be structured in the following format:

```
[<id>]
<text>
```

The <id> field, keeping the brackets, will be the code that identifies the help text inside the file, which needs not be the same as the number of the error or message it will be associated with. The <text> field will be the information text that may have up to 500 characters including line feeds.

For example, the OEM.txt file will have the following structure.

```
[10]
Help text.
[27]
Help text.
[33]
Help text.
```

Calling the texts from the PLC message or from the PLC error.

To associate the help message with a PLC message or PLC error, the "associated file" field must be defined like <file>#<id>. The <file> field will be the path and the name of the file. The <id> field will be the code that identifies the help text inside the file.

For example, the "associated file" will be defined as follows.

```
C:\CNC8070\MTB\PLC\LANG\OEM.txt#27
```

18.

PLC
"Messages" service

18.13.6 Save, load and print a message and error table

Save table

To save the table data, press the "Save" softkey and the CNC will show a list with the files saved at the CNC.

To save the table data:

- 1 Select the destination folder.
- 2 Define the file name at the bottom window. To replace an existing file, select it from the list.
- 3 Press [ENTER] to save the file or [ESC] to cancel the operation.

The file will be saved with the extension: *.MEF.

Load table

To recover the table data, press the "Load" softkey, the CNC will show a list with the files available at the CNC.

To load the table data:

- 1 Select the folder where the file is.
- 2 Select the file or write its name at the bottom window.
- 3 Press [ENTER] to accept the selection or [ESC] to cancel it and close the file listing.

Print table

This softkey may be used to print the table of messages and errors in the pre-determined printer or save it as a file (prn format) at the CNC. When selecting the "File" option, it will be saved in the folder "C:\Cnc8070\Users\Reports\".

When selecting this option, the CNC will show a dialog box requesting the print destination (printer or file). After selecting the destination, press [ENTER] to print it or [ESC] to cancel it.

18.PLC
"Messages" service**FAGOR** CNC 8060
CNC 8065

(REF: 1402)

18.

PLC

"Messages" service



CNC 8060
CNC 8065

(REF: 1402)

19.1 Appearance of the machine parameter tables

In order for the machine tool to be able to properly execute the programmed instructions, the CNC must know the specific data of the machine such as feedrates, accelerations, feedback, automatic tool change, etc. This data is set by the machine manufacturer and must be defined in the machine parameter table.

At a CNC with a write-protected (read-only) disk, working in user mode, the machine parameters are write-protected and any changes made to it are temporary; i.e. it will disappear the next time the unit is turned on. To make the changes permanent, unprotect the machine parameters by starting the unit up in setup mode and validating the changes made.

Selecting the machine parameter tables.



This operating mode consists of several tables. The various tables may be selected using the horizontal softkeys. If while one of the tables is selected, the [BACK key is pressed, that table will be deselected.

- General parameters.
- Axis and spindle parameters.
- Jog parameters.
- Parameters related to the "M" functions.
- Parameters for kinetics.
- Parameters for the magazines.
- HMI parameters.
- OEM parameters.

Parameter setting

To set the machine parameter tables, proceed as follows:

1 Edit the values of the tables.

First, set the general machine parameters because they define the axes of the machine, thus the axis machine parameters.

The general machine parameters can also be used to define the data for the cross compensation.











Use the axis machine parameters to determine whether leadscrew error compensation will be applied or not and define the data of the corresponding table.

2 Validate the table data. This operation is a must after defining the parameters of the tables and every time any of the data is modified.

3 Save the data of the table. It is recommended to save the data of the machine parameter table so as to have a backup copy of them. The data may be stored at the CNC, in a floppy disk or at another CNC (or PC) connected through Ethernet.

19.1.1 Softkey menus.

Vertical softkey menu.













Softkey.	Description.
	Show more options on the softkey menu.
	Toggle between the two types of units used to represent the parameters that depend on those units (coordinates, feedrates, etc.). The softkey highlights the units currently selected (millimeters or inches). The CNC will display this softkey or not depending on how machine parameter MMINCHSOFTKEY has been set.
	Initialize the table. It resets all the parameters to their default values. The CNC will request confirmation of the command.
	Search a text or a value in the table. When selecting this option, the CNC shows a dialog box requesting the text to be found.
	Validate the table data. If there is no table selected, all the data of all the tables will be validated. This table is necessary after changing a data. In certain cases, the CNC will have to turned off and back on in order for the data to be validated.
	Save the values of the table into a file. If there is no table selected, all the data of all the tables will be saved.
	Restore the values of the table previously saved into a file. If there is no table selected, all the data of all the tables will be recalled.
	Print the table in the pre-determined printer or save it as a file (prn format) at the CNC.
	Activate the TEACH-IN work mode in order to set the leadscrew and cross compensation tables.
	Export the cross compensation and leadscrew error compensation tables out to an ASCII file. The files will have the extension mp.
	Import the cross compensation and leadscrew error compensation tables that were previously saved in a file.

19.

MACHINE PARAMETERS
Appearance of the machine parameter tables



19.2 Parameter table description

The machine parameter tables have the following structure:

GENERAL PARAMETERS				
Mnemonic	Value	Unit	Limits	Default Value
 NCHANNEL	2		[1..4]	1
 NAXIS	6		[1..20]	3
 AXISNAME				
TANDEM				
GANTRY				
 MULTIAxis				
 B NSPDL	C	D	E	F
 SPDLNAME				
 LOOPTIME	4	ms	[1.0000..20.0000]	4
PRGFREQ	2	cycles	[1..100]	2
SERBRATE	4 Mbps			4 Mbps
SERPOWSE	4		[1..8]	2
MLINK	No			No
 CANMODE	CANfagor			CANfagor
Number of axes of the G m (spindle not included)				

- A Name of the selected machine parameter table.
- B Parameter list.
- C Parameter value, set by the user.
- D Units used to define the parameter.
- E Limit values for the parameter.
- F Default value of the parameter.
- G Parameter description.

The section on ["19.3.1 Data editing and validation"](#) in this chapter shows how to edit the parameters of the tables. Certain parameters cannot be edited; they only access a set of parameters or a data table. These parameters will be identified as follows.

	To access a group of parameters.
	To access a data table.

To access the data associated with the parameter, select the parameter with the cursor and press [ENTER]. To return to the previous parameter table, press [ESC].



To obtain further information about the data appearing in the table, refer to the chapter on machine parameters of the installation manual.

19.

MACHINE PARAMETERS
Parameter table description



CNC 8060
CNC 8065

(REF: 1402)

19.2.1 "M" function setting table

This table is accessed using the M-function machine parameter "DATA" and it has the following structure:

M FUNCTION TABLE : M VALUES					
MNUM	SYNCHTYPE	MPROGRAMME	MTIME	MPLC	COMMENT
12	Before-After		0	Yes	
15	Without Sync		0	Yes	
00	Before-Before		0	Yes	
	Before-Before		0	Yes	
	Before-Before		0	Yes	
	Before-Before		0	Yes	
	Before-Before		0	Yes	
	Before-Before		0	Yes	
	Before-Before		0	Yes	
	Before-Before		0	Yes	
	Before-Before		0	Yes	
	Before-Before		0	Yes	
	Before-Before		0	Yes	
	Before-Before		0	Yes	
	Before-Before		0	Yes	
	Before-Before		0	Yes	
	Before-Before		0	Yes	
	Before-Before		0	Yes	
	Before-Before		0	Yes	
	Before-Before		0	Yes	

- A Name of the selected machine parameter table.
- B List of user defined "M" functions.
- C Type of synchronism.
- D Associated subroutine.
- E Time for execution time estimate.
- F Send the M function to the PLC during block search.
- G Function describing comment.
- H Parameter description.

The section on "[19.3.1 Data editing and validation](#)" in this chapter shows how to edit the parameters of the tables.



To obtain further information about the data appearing in the table, refer to the chapter on machine parameters of the installation manual.

19.

MACHINE PARAMETERS
Parameter table description



CNC 8060
CNC 8065

(REF: 1402)

19.2.2 Compensation table

There are two types of compensation table:

- Leadscrew error compensation, that is accessed with the axis machine parameter "LSCRWDATA" when the compensation is active.
- Cross compensation, which is accessed with the general machine parameter "CROSSCOMP".

These compensation tables have the following structure:

X AXIS : LSCRWDATA VALUES A			
Mnemonic	POSITION	POSError	NEGERROR
LSCRWDATA 0	12.4030	0.5821	0.3258
LSCRWDATA 1	15.2150	0.4523	0.4126
LSCRWDATA 2	18.3250	0.3258	0.5236
LSCRWDATA 3	20.5854	0.3688	0.6254
LSCRWDATA 4	21.4654	0.2147	0.7254
Error in F positive direction			

- A Name of the selected machine parameter table.
- B Compensation point.
- C User defined axis position.
- D Amount of error to compensate in the positive direction.
- E Amount of error to compensate in the negative direction.
- F Parameter description.

Sections "19.3.1 Data editing and validation" and "19.3.4 Importing and exporting compensation tables." of this chapter show how to edit the parameters of the tables.



To obtain further information about the data appearing in the table, refer to the chapter on machine parameters of the installation manual.

19.

MACHINE PARAMETERS
Parameter table description

19.2.3 OEM parameters

The OEM parameters may be read and written directly in the table or through their associated variables. The "SIZE" parameter indicates the number of parameters in the table. The table, which is accessed with the general machine parameter "DATA", has the following structure.

19.

MACHINE PARAMETERS
Parameter table description

MTBPAR (A) DATA					
Mnemonic	VALUE	MODE	INCHES		COM
P0	0.0000	Read ▼	No	▼	
P1	0.0000	Read ▼	No	▼	
P2	0.0000	Read ▼	No	▼	
P3	0.0000	Read ▼	No	▼	
P4	0.0000	Read ▼	No	▼	
(B) P5	(C) 0.0000	(D) Read ▼	(E) No	▼	(F)
P6	0.0000	Read ▼	No	▼	
P7	0.0000	Read ▼	No	▼	
P8	0.0000	Read ▼	No	▼	
P9	0.0000	Read ▼	No	▼	
P10	0.0000	Read ▼	No	▼	
P11	0.0000	Read ▼	No	▼	

OEM par (G) meter

- A Name of the selected machine parameter table.
- B Name of the parameter.
- C Value of the parameter.
- D Mode for accessing the parameter from its variable.
- E The parameter is affected by the change of units.
- F Function describing comment.

The values of the table may be modified at any time. The new values are assumed immediately without having to validate the parameters. This means that the values and permissions of the table may be modified while executing a program.

The simulation environment has a copy of this table. On CNC power-up, the values of the parameters of the real table are copied into the simulation table and from there on, they become different in the writing of the variables of both tables.

In the simulation table, only the parameter values may be modified, not the rest of the permissions. The values of the simulation table can only be read or modified through their variable.



To obtain further information about the data appearing in the table, refer to the chapter on machine parameters of the installation manual.



CNC 8060
CNC 8065

(REF: 1402)

19.3 Operations with tables



19.3.1 Data editing and validation

Use the softkey menu to select the desired machine parameter table. To edit the table data, proceed as follows:

- 1 Use the cursor to select the parameter whose value is to be set.
- 2 Key in the desired value. If [SUP] is pressed, the parameter will assume the default value.
- 3 Press [ENTER] to accept the new value or [ESC] to ignore the new value and recover the previous one.

Parameter types

Certain parameters can only assume specific values. These parameters will be identified as follows.

	The parameter has a list of options.
	The parameter refers to a file.

Depending on the type of values they can assume, they will be defined as follows:

- If the parameter may assume a value between specific limits, enter the desired value. If the value exceeds those limits, the parameter will assume its default value.
- If the parameter contains a list of options, press [ENTER] to display the drop list and select one of those options.
- If the parameter refers to a file, press [ENTER] and the CNC will show the list of available files.

Data validation.



After editing or modifying the table data, the new values must be validated so they are assumed by the CNC. To validate the data, press the VALIDATE softkey. To validate certain parameters, restart the CNC. These parameters will be identified with the following symbol next to their name:

	Restarting the CNC required.
---	------------------------------

19.3.2 Save and recall tables

Save a table.



This softkey is used to save the table data, in ASCII format, in a file. Use the softkey menu to select the table whose data is to be saved. If no table is selected, all the data of all the tables will be saved. After selecting the table whose data is to be saved, press the "Save" softkey and the CNC shows a list with the tables that are already saved. To save the table data, proceed as follows:

- 1 Select the destination folder.
- 2 Define the file name at the bottom window. To replace an existing file, select it from the list.
- 3 Press [ENTER] to save the file or [ESC] to return to the table without saving the file.

The files are saved with the extension *.MP.

Recall a table.



This softkey is used to restore the table data from an ASCII file. Use the softkey menu to select the table whose data is to be recalled (restored). If no table is selected, all the data of all the tables will be recalled. After selecting the table whose data is to be restored, press the "Load" softkey and the CNC shows a list with the tables that are already saved. To recover the table data, proceed as follows:

- 1 Select the folder containing the file.
- 2 Select the file from the list or write its name in the bottom window.
- 3 Press [ENTER] to recall the data from the file or [ESC] to return to the table without recalling the data.

19.

MACHINE PARAMETERS Operations with tables



CNC 8060
CNC 8065

(REF: 1402)

19.3.3 Find text.



This softkey is used to find text or a value in the table. After pressing this softkey, the CNC shows a dialog box requesting the text or value to be found. It is also possible to select whether the search must start at the beginning of the table or at the current cursor position.

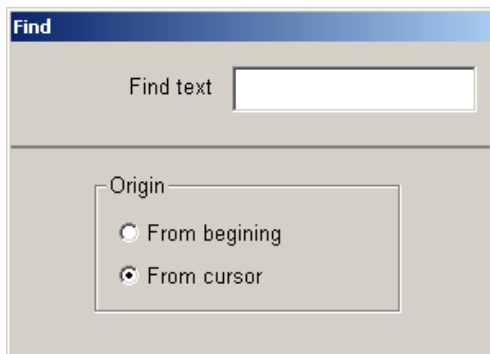

Key.	Meaning.
	Move the cursor.
	It selects an option from a group.
	Start the search.
	Cancel the search and close the dialog box.



After defining the search options, press [ENTER] to do the search or [ESC] to cancel it. Pressing [ENTER] positions the cursor in the first field that matches the search parameters. Pressing this FIND icon again will allow repeating the search or defining a new one.

19.

19.3.4 Importing and exporting compensation tables.

The cross compensation and leadscrew error compensation tables are saved and restored with the rest of general parameters and axis parameters using the softkeys "Save table" "Restore table". These tables may be exported and imported individually using the softkeys "Export table" and "Import table".



This softkey may be used to save the machine parameter table in an ASCII file. This softkey saves all the parameters of the table.



This softkey may be used to restore the machine parameter table from an ASCII file. This softkey restores all the parameters of the table.



When loading general parameters or axis parameters, neither the cross compensation tables nor the leadscrew error compensation tables are used.



This softkey may be used to export the cross compensation or leadscrew error compensation table being displayed out to an ASCII file.

This softkey may be used to import the cross compensation and leadscrew error compensation table from an ASCII file.

When saving the cross compensation and leadscrew error compensation tables, we recommend to use the axis name as the file name in order to identify it more easily; for example, LSCRWX.mp for leadscrew error compensation tables and CROSS_XY.mp for cross compensation tables.

Generating the ASCII file for cross compensation and leadscrew error compensation manually.

In order to save time and eliminate transcription errors, instead of entering the data manually, it is possible to adapt the format of a text file that contains the result of the measurement and import it later on. The file of points must have the extension mp and meet the following requirements.

- The points of the table must be ordered by their position on the axis and the table must begin by the most negative point (or least positive) to be compensated. For axis positioning outside this area, the CNC will apply the compensation that was defined for the nearest end.
- The machine reference point, whose position is indicated in parameter REFVALUE, must have -0- error.
- For the leadscrew error compensation table, the maximum slope allowed is -1; i.e. the compensation steps must not exceed the position step between two consecutive points.

The format of the file must be like in the following example. The first column, as well as the titles of the columns, are optional and do not appear in the mp file when exporting the tables. The data of the tables may be separated by a blank space or by a tabulator.

POINT	POSITION	POERROR
0	-10,0000	-0,0023
1	0,0000	-0,0007
2	10,0000	0,0043
3	20,0000	0,0036
...

When using bi-directional compensation, a new column must be inserted in the table with the amount of error to be compensated when moving in the negative direction.

19.

MACHINE PARAMETERS Operations with tables



CNC 8060
CNC 8065

(REF: 1402)

The set of utilities of the setup assistance is meant to speed up and simplify the machine setup procedure. The different tools are accessed from the horizontal softkey menu.



The oscilloscope.



The Bode diagram.



The circularity (roundness) test.

It must be borne in mind that these utilities are assistance tools that only show the system's response to the various adjustments; it is always up to the technician to choose the best adjustment.

The oscilloscope

The oscilloscope is an assistance tool for adjusting the CNC and the drives. This utility can graphically show 4 previously selected variables, modify their values and check the different responses of the system.

Using the oscilloscope, it is possible to edit the CNC's machine parameters that affect the adjustment; it is also possible to modify at the Sercos drives the variables that have writing permission and it is possible to change the variables and parameters at the Mechatrolink devices (Mlink-II). In any case, a protection password is required for modifying the CNC's machine parameters or the variables of a Sercos drive.

The Bode diagram

The Bode diagram is an assistance tool for adjusting the CNC and the drives. This utility may be used to obtain the Bode diagram of the response amplitude depending on the frequency of the input signal. With this tool, it is possible to insert a sinusoidal signal into an axis, so that changing the frequency and analyzing the response provides the behavior of the axes at different frequencies and will give the user an idea of how it behaves with any signal.

This diagram may be used to check the system's gain, the bandwidth and the mechanical resonance. All this helps achieve the proper adjustment of the loops, analyze mechanical problems and check the final features.

The circularity (roundness) test

This tool helps improve and adjust the axis reversal peak, an effect that appears when the axes reverse their moving direction. With this utility, a circle may be executed with the axes and graphically show the result. This graphic shows the difference between the actual (real) coordinate obtained from the feedback device and the theoretical coordinate calculated at each point.

The same screen showing the graphics also shows the machine parameters that affect the movement reversal. These parameters may be modified while running the test, thus being possible to evaluate the response of the system to these changes and optimize the adjustment on the go.

20.1 Oscilloscope

The oscilloscope is an assistance tool for adjusting the CNC and the drives and can graphically show 4 previously selected variables, modify their values and check the different responses of the system. Together with the circularity test and the bode diagram, the oscilloscope helps speed up and simplify the machine setup process.



The oscilloscope function requires Sercos communication and a drive version V06.01 or later. Otherwise, the CNC will show the error "Access denied".

The oscilloscope function is not available with the ACSD drives.

Using the oscilloscope, it is possible to edit the CNC's machine parameters that affect the adjustment; it is also possible to modify at the Sercos drives the variables that have writing permission and it is possible to change the variables and parameters at the Mechatrolink devices (Mlink-II). In any case, a protection password is required for modifying the CNC's machine parameters or the variables of a Sercos drive.

The oscilloscope is an assistance tool that only shows the response of the system to the various settings (adjustments); it is up to the technician to choose the best adjustment.

20.

SETUP ASSISTANCE
Oscilloscope



CNC 8060
CNC 8065

(REF: 1402)

20.1.1 Interface description

The screen of the oscilloscope function looks like this, with two clearly different parts. The left side and the lower side show the data of the variables to be shown, the trigger data, the time base and the parameters that may be acted upon. The top right side shows the variables graphically.

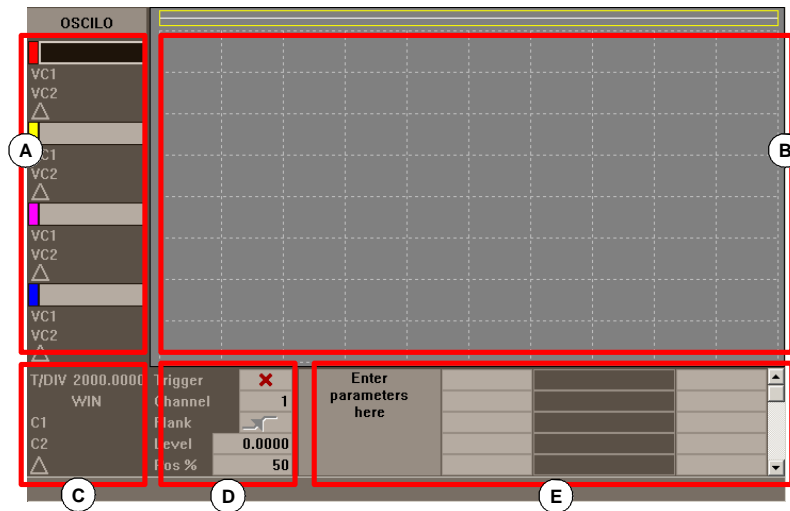

- A Variables to represent in the graphic window. Up to 4 variables may be displayed at the same time. The visibility and color associated with each variable may be defined in the configuration page.
- B Graphic window where the selected variables are represented. For each variable, it shows the scale used to draw it.
- C Time base.
- D Trigger. In this area, the user may select the trigger conditions.
- E Machine parameters to be set. With the oscilloscope, it is possible to change the value of up to 20 machine parameters to check their effect during the adjusting process.

Some of this data may also be defined at the configuration screen. See ["20.1.3 Configuration screen"](#) on page 345.

Trigger data,

In this area, the user may select the trigger conditions. The options offered by this trigger data area are:

- Trigger The trigger indicates when the data capture begins. If selected, the trigger condition must be specified with the "Flank", "Level" and "Position" data.

If not selected, the data capture begins as soon as the user gives the command to begin. The "Flank", "Level" and "Position" data are ignored.
- Channel The channel indicates which variable or channel (CH1, CH2, CH3, CH4) is to be used as reference or trigger condition.
- Position (%) The (%) position is taken into account when Trigger has been selected and it is defined as a percentage between 0% and 100%. It indicates the number of samples to be taken before the Trigger. For example, a 10% position indicates that 10% of the total number of programmed samples will be taken before the Trigger and the remaining 90% after that instant.

The Trigger condition is evaluated after gathering the indicated % of samples. If the position is defined as 50% and the Trigger condition takes place after taking 10% of the samples, it is ignored until capturing 50% of the samples.
- Flank It may be up-flank (leading edge) or down-flank (trailing edge). It is taken into account when trigger has been selected.
- Trigger level It sets the value to be assumed by the variable to start capturing data. It is taken into account when trigger has been selected.







CNC 8060
CNC 8065

(REF: 1402)

20.1.2 Softkey menus.

Horizontal softkey menu.

The horizontal softkey menu offers the following options:

Softkey.	Description.
Softkey "Config".	This softkey accesses the configuration screen. It may be used to define which variables will be displayed, their scale, colors, time base, the Trigger, the trigger condition, the parameters to act upon, etc.
Softkey "Data".	It accesses the data processing submenu. This submenu serves to save and load the captured trace as well as the configuration defined for it. It may also be used to send data of the captured trace out to printer or to a file.
Softkey "Enlarge screen". 	With this option, it is possible to enlarge the graphics window to the left, using the area that shows the variables to be displayed. Pressing the same softkey returns the screen to the previous size.
Softkey "Overlap channels".	With this option, several channels may be overlapped.
Softkey "Autoscale".	When autoscaling a channel, the system determines the proper vertical scale and offset so the signal appears as enlarged as possible inside its graphic area.
Softkey "Begin capture". 	Start taking data to show it graphically.
Softkey "End capture". 	Finish the data capture and stop the graphic representation.
Softkey "Freeze screen". 	Freeze the display without interrupting the data capture. This softkey only appears on the horizontal softkey menu if the capture is in continuous mode. To set the capture in continuous mode, change the "mode" option of the configuration screen.
Softkey "Unfreeze capture". 	Unfreeze the display.

Vertical softkey menu.

Depending on which data has the focus, the vertical softkeys show different options.

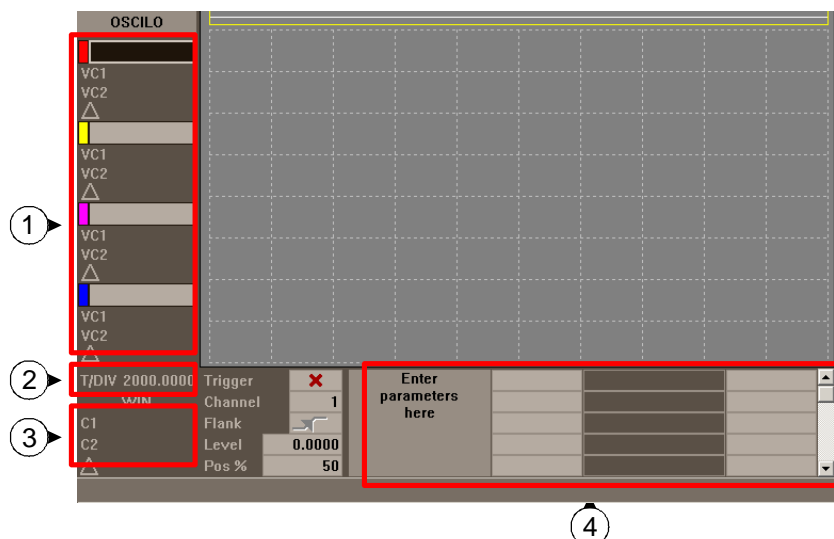

20.

SETUP ASSISTANCE
Oscilloscope



CNC 8060
CNC 8065

(REF: 1402)

Zone 1. Focus on a variable of a channel.

When the focus is on any of the variables, the vertical softkeys will be:

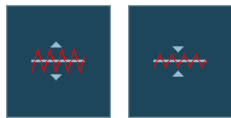

The scale of the graphic may be changed with the "scale" softkeys. The new scale value will appear on the graphic next to the corresponding variable.

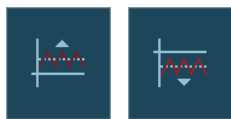

The graphics of the desired channel may be moved up and down using the offset softkeys.



This softkey may also be used to center the graphics.



When the focus is on any of the variables, a new variable name may be either keyed in or selected without having to go to "CONFIG".

Zone 2. Focus on the "T/Div" field.

When the focus is on the "T/Div" field, the following softkeys will appear.

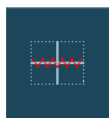

Using the autoscale softkey, the oscilloscope selects the right time scale so the signal appears as large as possible inside its corresponding graphic area.

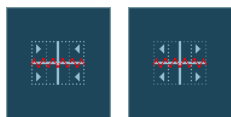

It increases or decreases the time scale.

Zone 3. Focus on the "WIN", "C1" and "C2" field.

With "WIN", it shows the oscilloscope window where it is. Cursors "C1" and "C2" may be used to analyze each signal of the last data capture. These two cursors may be used to obtain the position in milliseconds of each signal and the time difference between them "Δ".

When the focus is on one of these fields, the following vertical softkeys will be shown.



It takes the window to the beginning or to the end.



It takes the window to the trigger. If there is no trigger, it will go to the center of the window.



Moves the window to the left or to the right.

Zone 4. Focus on the "parameter name" field.

As with variables, by selecting the various parameters, it is possible to change their names and values.

When pressing [ENTER] after changing the name of a parameter, use the [←][→][↑][↓] keys to move the focus to the next field to change the value of that parameter. After changing the parameter value and pressing [ENTER], the focus does not go on to the next field. Use the arrow keys to go on to the next parameter. When the focus is on this field, the 4 vertical softkeys will be:



It increases the value of the parameter in the amount indicated on the configuration screen.

20.

SETUP ASSISTANCE
Oscilloscope

It decreases the value of the parameter in the amount indicated on the configuration screen.



It resets the parameter to its default value.



It validates the value given to the parameter.



Using the "Config" softkey, a screen may be accessed where it is possible to define the list of parameters to be displayed.

20.1.3 Configuration screen

The configuration screen may be accessed with the horizontal softkey "CONFIG". This screen looks like this with two clearly different areas. The left side shows the data of the variables to be displayed, the trigger data and the time base. The right side shows the parameters to be acted upon and the amount to increase/decrease the values of those parameters.

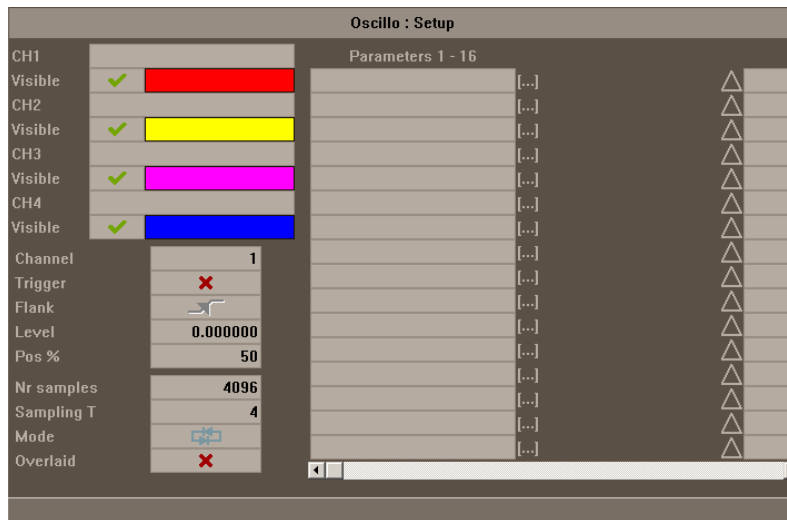

Selection of the variables to be displayed, trigger and time base

It is the area where the user selects the variables to be displayed at the graphics window, the trigger options and the time base. Up to 4 variables may be displayed at the same time. When typing the name of any variable incorrectly, the CNC will show the error "Access denied".

Besides the trigger data and the base time, this window may be used to select the color used to display the variable and whether it will be visible or not.

The sampling period.

The sampling period must be multiple of the machine parameter LOOPTIME; if a wrong value is entered, the CNC will set it to the right one.

When capturing only two variables of the same drive, it is possible to set a sampling time shorter than LOOPTIME. In this case, the sampling period must be multiple of 0.0625 ms which is the minimum allowed. Not all the variables of the drive accept this sampling time. The CNC will issue an error message when trying to represent a wrong variable.

Parameter selection and increase/decrease

It is the area where the user selects the parameters upon which to act. To the right of each parameter, there is a square used to increase/decrease of its value.

This way, when the focus is on the value of a variable on the main screen, pressing the vertical softkey "V+" will increase the parameter value in the amount set on the configuration screen.

By default, the increase/decrease value of a parameter is initialized to 1.

20.

SETUP ASSISTANCE
Oscilloscope

FAGOR 

CNC 8060
CNC 8065

(REF: 1402)

20.1.4 Configure and execute the oscilloscope function

In the oscilloscope mode, from a single screen, it is possible to select the variables to be analyzed, the trigger conditions and the machine parameters of the CNC or the drive that may be modified.

Operating procedure

- 1 Execute a part-program to move the axis or axes to be adjusted. Once the program is running, go into the adjustment mode and access the oscilloscope function.
- 2 At the oscilloscope, define the variables to be analyzed, the trigger conditions and the machine parameters of the CNC or the drive that may be modified.



When capturing 1 or 2 variables of the same drive, the capture will be done by the drive itself and the CNC will be in charge of drawing the results. When capturing more than 2 variables or 2 variables from different drives, in order to synchronize data, the capture will be done by the CNC and the sampling period will be the CNC's cycle time.

- 3 Data capture and later analysis of the data.
- 4 Once the data capture has been interrupted or completed, it is possible to analyze the signals and modify the parameters that have been previously selected in order to improve the machining conditions.
- 5 Repeat the capture, the analysis and the modification of parameters until obtaining the best machining conditions.

Recommendations

Execute endless repetitive movements. After adjusting the axes individually, readjust the interpolating axes together. The user must determine which is the best adjustment, the oscilloscope function is just an assistance tool.

How to operate the oscilloscope.

To enter or modify a data on the screens, it must be selected; in other words, it must have the editing focus on it. Use the [↑][↓] keys to select another editable data or field. It is a rotary selection, if the [↑] key pressed when the first element of the screen is selected, the focus goes to the last element whereas if the [↓] is pressed when the last element is selected, the focus goes to the first element.

Not all the fields are editable, only the ones that may be selected can be edited, those having the focus. There are two types of editable fields:

- Editable values:

They may be assigned a value, either a two-digit number or alphanumeric (numbers and letters). Before validating the data, it is checked out and if it is not correct, it will not be accepted and a warning message will be issued.
- Values that may be selected:

The possible data are fixed one of them must be selected. Use the [→][←] keys to see the possible values. For this type of values that are icons, the [SPACE] key has the same effect as the [→] key.



CNC 8060
CNC 8065

(REF: 1402)

20.1.5 Machine parameter editing.



The new values are assumed by the CNC after pressing [ENTER] and they are maintained until the unit is turned off. Once the setup is completed, the changes must be saved so they can be effective next time the CNC is turned on.

Use the "Validate" softkey to save the data. The CNC saves the new values in the CNC tables and/or in the drive tables accordingly.

Here is a list of machine parameters and variables of the drive that may be modified from the oscilloscope.

Axis or spindle machine parameters that may be edited

The table indicates the parameters that will be assumed at the beginning of the next block. For this to be so, the instruction "#SYNC POS" must be programmed after each motion block.

CNC	Drive	Associated variable	Update
PRELOAD		MPG.PRELOAD[tandem]	Immediate
PRELFIT1		MPG.PRELFIT1[tandem]	Immediate
TPROGAIN		MPG.TPROGAIN[tandem]	Immediate
TINTIME		MPG.TINTIME[tandem]	Immediate
TCOMPLIM		MPG.TCOMPLIM[tandem]	Immediate
INPOSW		MPA.INPOSW.[gamme].axis	Immediate
BACKLASH	PP58	MPA.BACKLASH.[set].axis	Immediate
G00FEED		MPA.G00FEED.[set].axis	Beginning of next block
MAXVOLT		MPA.MAXVOLT.[set].axis	Immediate
PROGAIN	PP104	MPA.PROGAIN.[set].axis	Immediate
FFGAIN	PP216	MPA.FFGAIN.[set].axis	Immediate
MANFFGAIN	PP216	MPA.MANFFGAIN.[set].axis	Immediate
ACFWFACTOR		MPA.ACFWFACTOR.[set].axis	Immediate
ACFGAIN	PP217	MPA.ACFGAIN.[set].axis	Immediate
MANACFGAIN	PP217	MPA.MANACFGAIN.[set].axis	Immediate
LACC1		MPA.LACC1.[set].axis	Beginning of next block
LACC2		MPA.LACC2.[set].axis	Beginning of next block
LFEED		MPA.LFEED.[set].axis	Beginning of next block
ACCEL	PP42	MPA.ACCEL.[set].axis	Beginning of next block
DECEL	PP42	MPA.DECEL.[set].axis	Beginning of next block
ACCJERK		MPA.ACCJERK.[set].axis	Beginning of next block
DECJERK		MPA.DECJERK.[set].axis	Beginning of next block
ESTDELAY		MPA.ESTDELAY.[set].axis	Immediate
SERVOOFF		MPA.SERVOOFF.[set].axis	Immediate
MINANOUT		MPA.MINAOUT.[set].axis	Immediate
BAKANOUT	PP2	MPA.BAKANOUT.[set].axis	Immediate
BAKTIME	PP3	MPA.BAKTIME.[set].axis	Immediate
PEAKDISP	PP14	MPA.PEAKDISP[set].axis	Immediate
REVEHYST	PP15	MPA.REVEHYST[set].axis	Immediate
FBMIXTIME	PP16	MPA.FBMIXTIME.axis	Immediate
FLIMIT		MPA.FLIMIT.axis	Immediate
SLIMIT		MPA.SLIMIT.axis	Immediate

20.

SETUP ASSISTANCE
Oscilloscope

FAGOR 

CNC 8060
CNC 8065

(REF: 1402)

CNC	Drive	Associated variable	Update
MAXACCEL		[ch].G.MAXACCEL	Beginning of next block
MAXJERK		[ch].G.MAXJERK	Beginning of next block
SERVOOFF		MPA.SERVOOFF[set].axis	Immediate

If the machine parameters are protected, when accessing any of them, the CNC will display a window requesting a password.

20.

SETUP ASSISTANCE
 Oscilloscope

Variables that may be modified at the Sercos drive

Drive	Name	Update
CP1	CP1.axis	Immediate
CP2	CP2.axis	Immediate
CP3	CP3.axis	Immediate
CP30	CP30[set].axis	Immediate
CP31	CP31[set].axis	Immediate
CP32	CP32[set].axis	Immediate
NP1	NP1.axis	Immediate
RP1	RP1.axis	Immediate
RP2	RP2.axis	Immediate
RP3	RP3.axis	Immediate
RP4	RP4.axis	Immediate
RP51	RP51.axis	Immediate
RP52	RP52.axis	Immediate
RP53	RP53.axis	Immediate
RP54	RP54.axis	Immediate
SP1	SP1[set].axis	Immediate
SP2	SP2[set].axis	Immediate
SP50	SP50.axis	Immediate
SP51	SP51.axis	Immediate
TP10	TP10.axis	Immediate
TP11	TP11.axis	Immediate
TP12	TP12.axis	Immediate
TP13	TP13.axis	Immediate
TP14	TP14.axis	Immediate

Besides the parameters shown in the previous table, the user may access any variable having a writing permission if he knows its name. To do this, use the following nomenclature:

Indicate the axis, the name of the parameter and the set separated by a period.

When modifying any parameter of the previous table, the change is effective immediately without having to reset or restart the unit even when there is a program in execution.

The drive parameters modified with this method are functional immediately, but these values will be lost when the drive is turned off. Use the "Save to flash" option to maintain the modified values of those machine parameters.

Variables and parameters that may be modified at a Mechatrolink device.

Access from the oscilloscope to variables and parameters of the device is only available for the Mlink-II mode with 32 bytes. It is not possible to access the parameters and variables of the same device at the same time.



CNC 8060
CNC 8065

(REF: 1402)

The oscilloscope can represent up to two variables of each device that may be DRV variables or the device's own variables (MLINK0 to MLINKF). These variables will be associated with the devices through their name (MLINK7.X) or through the node number (MLINK7.1).

The oscilloscope can access the parameters of the device using its identifier (hexadecimal number between P0000 and PFFFF).

Saving, loading and resetting the configurations

When defining a new configuration of variables to be displayed and parameters modified at the oscilloscope, the system allows saving that configuration into a file. Likewise, the system allows loading a configuration that was saved previously or resetting the current configuration.

Save

To save the current configuration, go to the configuration screen and press the "Save" softkey. After this, a new screen appears showing the available configurations with the focus on the last one. Also, it is possible to rename the new configuration whose extension must be ".osc".

Load

To load a previously saved configuration, go to the configuration screen and press the "Load" softkey. Then, a new screen appears showing a list of previously saved configurations, being possible to select any of them.

Reset

Pressing the "Reset" softkey of the configuration screen deletes or initializes the current configuration. There are neither variables nor parameters selected and the rest of conditions (colors, trigger, etc.) assume the values assigned by default.

20.**SETUP ASSISTANCE**
Oscilloscope**FAGOR** **CNC 8060
CNC 8065**

(REF: 1402)

20.2 The Bode diagram

The Bode diagram is an assistance tool for adjusting the CNC and the drives. This utility may be used to obtain the Bode diagram of the response amplitude depending on the frequency of the input signal.

With this tool, it is possible to insert a PRBS signal into an axis, so that changing the frequency and analyzing the response provides the behavior of the axes at different frequencies and will give the user an idea of how it behaves with any signal.

This diagram may be used to check the system's gain, the bandwidth and the mechanical resonance. All this helps achieve the proper adjustment of the loops, analyze mechanical problems and check the final features.

The Bode diagram is an assistance tool that only shows the response of the system to the various settings (adjustments); it is up to the technician to choose the best adjustment.



*The Bode diagram requires a drive version V6.11 or newer.
The Bode diagram is not available with the ACSD drives.*

20.

SETUP ASSISTANCE
The Bode diagram



CNC 8060
CNC 8065

(REF: 1402)

20.2.1 Interface description

The screen of the Bode diagram is similar to that of the oscilloscope and looks like this, with two clearly different parts. The left side and the lower side show the selected axis, the various ways to display the captured data, the time base or frequency base and the parameters that may be acted upon. The top right side shows the data graphically.

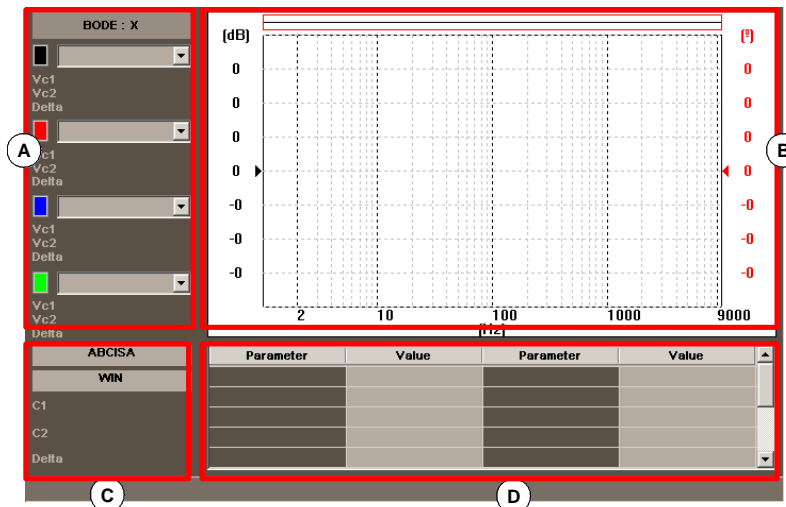

- A** Ways to represent the captured data in the graphic window. Up to 4 graphs may be displayed at the same time. The user can change the type of graph without having to do a new capture.
- B** Graphic window where the selected data is represented. For each graph, it shows the scale used to draw it.
- C** Time base.
- D** Machine parameters to be set. With the oscilloscope, it is possible to change the value of up to 22 machine parameters to check their effect during the adjusting process.

Some of this data may also be defined at the configuration screen. See ["20.2.4 Configuration screen"](#) on page 357.



20.

SETUP ASSISTANCE
The Bode diagram

20.2.2 Softkey menus.



Horizontal softkey menu.

The horizontal softkey menu offers the following options:

Softkey.	Description.
Softkey "Config".	This softkey accesses the configuration screen. It may be used to define the axis to obtain its Bode, the two variables (IN/OUT) that will be displayed, the types of graph to show the variables, its colors, the capture configuration and the movement configuration. The configuration screen offers the options to save, load or reset the current configuration and also load the reference Bode configuration.
Softkey "Data".	It accesses the data processing submenu. This submenu serves to save and load the captured trace as well as the configuration defined for it. It can also print the data about the captured trace.
Softkey "Views".	It accesses the submenu to display the graph.
Softkey "Scales".	It accesses the submenu to configure the abscissa and ordinate axes. This submenu may be used to activate the logarithmic scale on the abscissa axis.
Softkey "Begin capture". 	Start taking data to show it graphically.
Softkey "End capture". 	Finish the data capture and stop the graphic representation.



Treatment of the data and the captured trace.

The following options appear in the "Data" menu.

Softkey.	Description.
Save	Save the captured trace.
Load	Load a trace.
Print. 	Print the captured trace.
Save reference	Save the captured trace as a reference bode.
Load reference	Save a trace as a reference bode.
Convert into reference capture. 	It may be used to convert the data of the capture channels into a reference Bode with which to compare the capture just done or another one that is located in a file.

Treatment of the data and the captured trace.

The following options appear in the "Views" menu.

Softkey.	Description.
Enlarge screen. 	With this option, it is possible to enlarge the graphics window to the left, using the area that shows the data of the graphs to be displayed. Pressing the same softkey returns the screen to the previous size.
Overlap channels.	With this option, several channels may be overlapped.
Activate reference capture. 	It may be used to activate or cancel the reference Bode with which to compare the capture just done or another one that is located in a file.

20.

SETUP ASSISTANCE
The Bode diagram



CNC 8060
CNC 8065

(REF: 1402)

Vertical softkey menu.

Depending on which data has the focus, the vertical softkeys show different options.

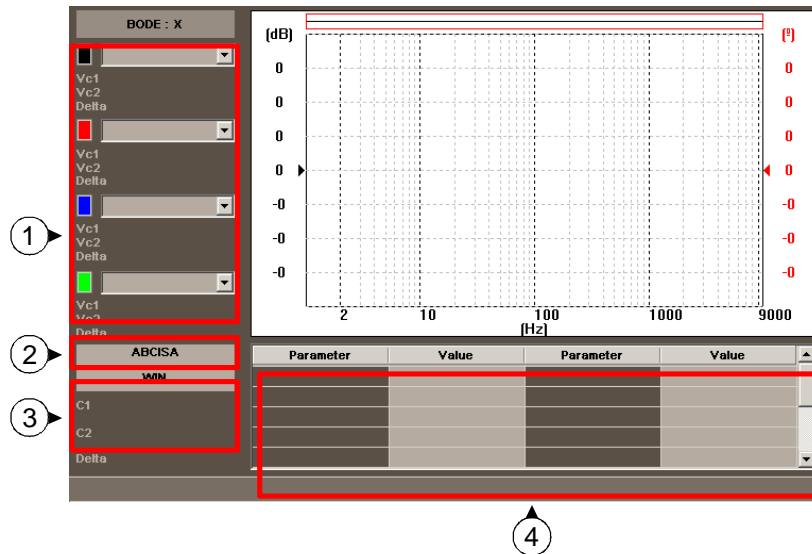

20.

SETUP ASSISTANCE
The Bode diagram

Zone 1. Focus on a type of graph.

When the focus is on any type graph, the following vertical softkeys will be shown.

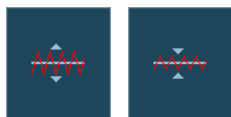

The scale of the graphic may be changed with the "scale" softkeys. The new scale value will appear on the graphic, in the same color as the type of graph.

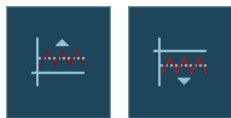

The desired graph may be moved up and down using the offset softkeys.



This softkey may also be used to center the graphics.



When the focus is on any of the variables, any type of graph may be either selected without having to go to the configuration screen or having to do another capture.

Zone 2. Focus on the "ABSCISSA" field

When the focus is on the "ABSCISSA" field, the following softkeys will appear.

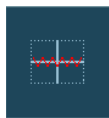

Using the autoscale softkey, the Bode selects the right time scale frequency scale so the signal appears as large as possible inside its corresponding graphic area.

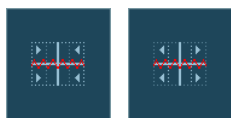

It increases or decreases the time scale or frequency scale.

Zone 3. Focus on the "WIN", "C1" and "C2" field.

Cursors "C1" and "C2" may be used to analyze each signal of the last data capture. These two cursors may be used to obtain the position in milliseconds or Hertz of each signal and the time difference between them "Δ".

When the focus is on one of these fields, the following vertical softkeys will be shown.



It takes the window to the beginning or to the end.



CNC 8060
CNC 8065

(REF: 1402)



It takes the window to the trigger. If there is no trigger, it will go to the center of the window.



Moves the window to the left or to the right.

Zone 4. Focus on the "parameter name" field.

Its value may be modified by selecting the various parameters. When pressing [ENTER] after selecting a parameter, use the [←][→][↑][↓] keys to move the focus to the next field to change the value of that parameter. After changing the parameter value and pressing [ENTER], the focus does not go on to the next field. Use the arrow keys to go on to the next parameter. When the focus is on this field, the 4 vertical softkeys will be:



It increases the value of the parameter in the amount indicated on the configuration screen.



It decreases the value of the parameter in the amount indicated on the configuration screen.



It resets the parameter to its default value.



It validates the value given to the parameter.

20.

SETUP ASSISTANCE
The Bode diagram



CNC 8060
CNC 8065

(REF: 1402)

20.2.3 Machine parameter editing.



The new values are assumed by the CNC after pressing [ENTER] and they are maintained until the unit is turned off. Once the setup is completed, the changes must be saved so they can be effective next time the CNC is turned on.

Use the "Validate" softkey to save the data. The CNC saves the new values in the CNC tables and/or in the drive tables accordingly.

Here is a list of machine parameters and variables of the drive that may be modified from the Bode.

Axis or spindle machine parameters that may be edited

The table indicates the parameters that will be assumed at the beginning of the next block. For this to be so, the instruction "#SYNC POS" must be programmed after each motion block.

CNC	Drive	Associated variable	Update
PRELOAD		MPG.PRELOAD[tandem]	Immediate
PRELFITI		MPG.PRELFITI[tandem]	Immediate
TPROGAIN		MPG.TPROGAIN[tandem]	Immediate
TINTIME		MPG.TINTIME[tandem]	Immediate
TCOMPLIM		MPG.TCOMPLIM[tandem]	Immediate
INPOSW		MPA.INPOSW.[set].axis	Immediate
BACKLASH	PP58	MPA.BACKLASH.[set].axis	Immediate
G00FEED		MPA.G00FEED.[set].axis	Beginning of next block
PROGAIN	PP104	MPA.PROGAIN.[set].axis	Immediate
FFGAIN	PP216	MPA.FFGAIN.[set].axis	Immediate
MANFFGAIN	PP216	MPA.MANFFGAIN.[set].axis	Immediate
ACFWFACTOR		MPA.ACFWFACTOR.[set].axis	Immediate
MANACFGAIN	PP217	MPA.MANACFGAIN.[set].axis	Immediate
LACC1		MPA.LACC1.[set].axis	Beginning of next block
LACC2		MPA.LACC2.[set].axis	Beginning of next block
LFEED		MPA.LFEED.[set].axis	Beginning of next block
ACCEL	PP42	MPA.ACCEL.[set].axis	Beginning of next block
DECEL	PP42	MPA.DECEL.[set].axis	Beginning of next block
ACCJERK		MPA.ACCJERK.[set].axis	Beginning of next block
DECJERK		MPA.DECJERK.[set].axis	Beginning of next block
SERVOOFF		MPA.SERVOFF.[set].axis	Immediate
BAKTIME	PP3	MPA.BAKTIME.[set].axis	Immediate

If the machine parameters are protected, when accessing any of them, the CNC will display a window requesting a password.

20.

SETUP ASSISTANCE
The Bode diagram

FAGOR 

CNC 8060
CNC 8065

(REF: 1402)

Variables that may be modified at the Sercos drive

Drive	Name	Update
CP1	CP1.axis	Immediate
CP2	CP2.axis	Immediate
CP3	CP3.axis	Immediate
CP30	CP30[set].axis	Immediate
CP31	CP31[set].axis	Immediate
CP32	CP32[set].axis	Immediate
NP1	NP1.axis	Immediate
RP1	RP1.axis	Immediate
RP2	RP2.axis	Immediate
RP3	RP3.axis	Immediate
RP4	RP4.axis	Immediate
RP51	RP51.axis	Immediate
RP52	RP52.axis	Immediate
RP53	RP53.axis	Immediate
RP54	RP54.axis	Immediate
SP1	SP1[set].axis	Immediate
SP2	SP2[set].axis	Immediate
SP50	SP50.axis	Immediate
SP51	SP51.axis	Immediate
TP10	TP10.axis	Immediate
TP11	TP11.axis	Immediate
TP12	TP12.axis	Immediate
TP13	TP13.axis	Immediate
TP14	TP14.axis	Immediate

Besides the parameters shown in the previous table, the user may access any variable having a writing permission if he knows its name. To do this, use the following nomenclature:

Indicate the axis, the name of the parameter and the set separated by a period.

When modifying any parameter of the previous table, the change is effective immediately without having to reset or restart the unit even when there is a program in execution.

The drive parameters modified with this method are functional immediately, but these values will be lost when the drive is turned off. Use the "Save to flash" option to maintain the modified values of those machine parameters.

20.

SETUP ASSISTANCE
The Bode diagram



CNC 8060
CNC 8065

(REF: 1402)

20.2.4 Configuration screen

The configuration screen may be accessed with the "Config" softkey. This screen shows four different areas.

- The selected axis and the two variables to be displayed.
- The selected types of graph.
- The capture configuration data.
- The data of the movement and of the excitation signal.

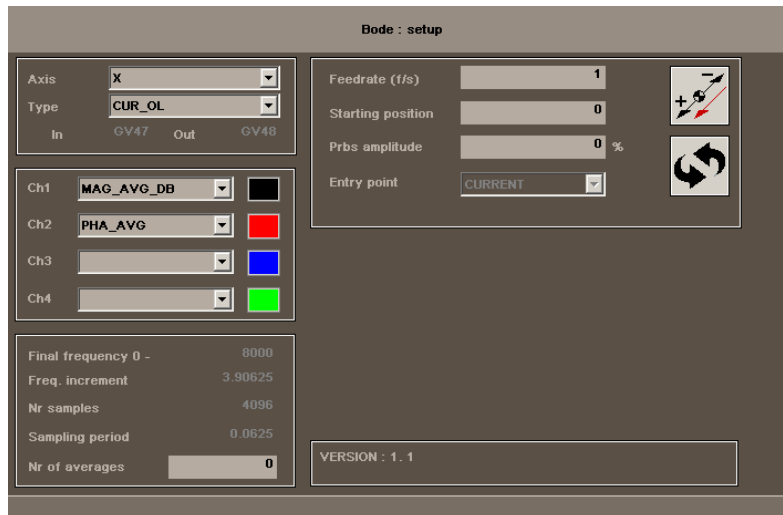

Axis

Axis whose Bode is to be obtained.

Type of capture

The variables that are captured (In/Out) are preset in all types of capture except in the "ADVANCED" type where they are set by the user.

Variable.	Meaning.
ADVANCED	"In/Out" variables that may be set by the user.
CUR_CL	Closed current loop. Current command / current feedback.
VEL_CL	Closed velocity loop. Velocity command / velocity feedback.
POS_CL	Closed position loop. Position command / position feedback.
CUR_OL	Open current loop.
VEL_OL	Open velocity loop.
POS_OL	Open position loop.
TF_CURCOM_MOTSPE	Transfer function. Current command / motor speed.
TF_MOTSPE_LOASPE	Transfer function. Motor speed / load speed.

20.

SETUP ASSISTANCE
The Bode diagram

FAGOR 

CNC 8060
CNC 8065

(REF: 1402)

Channels

Different ways to display the graph of the obtained data. The selected channels must have the same units in the abscissa axis, "time" graphs and "frequency" graphs cannot be displayed at the same time.

- "IN, OUT"

The captured signals themselves. They are "time" graphs; in other words, the scale of the abscissa axis is given in time units.

- "MAG, PHASE"

Gain and phase after transferring the "In/Out" variables. They are "frequency" graphs; in other words, the scale of the abscissa axis is given in frequency units (Hz).

Channel.	Meaning.
MAG_AVG PHASE_AVG	Average of the captures done so far.
MAG_DB PHASE_DB	Data in decibels.
MAG_OL PHASE_OL	Data in closed loop to which a mathematical transformation is applied to represent the open loop system.

- "COHERENCE"

Coherence after transferring the "In/Out" variables. It is a "frequency" graph; in other words, the scale of the abscissa axis is given in frequency units (Hz).

Captured data.

Except the "Number of averages" field that can always be edited, the rest of the fields can only be edited by the user when the type of capture is "ADVANCED".

- "FINAL FREQUENCY"

Maximum frequency displayed. It is directly related to the sampling period ($1 / 2 * \text{SamplingPeriod}$).

- "FREQUENCY INCREMENT"

Step between frequencies. It is directly related to the final frequency and the number of samples ($\text{FinalFrequency} / \text{NumberOfSamples}$).

- "SAMPLING PERIOD"

- "NUMBER OF SAMPLES"

- "NUMBER OF AVERAGES"

Number of consecutive captures performed automatically. Each capture involves the movement of the axis, the application of the PRBS and the capture itself.

Movement

- "FEEDRATE (F/S)"

Moving speed.



It changes the axis moving direction, positive or negative.

- "INITIAL POSITION"

Position where each capture begins.

- "PRBS AMPLITUDE"

Amplitude of the excitation signal.



It changes the units of the amplitude of the excitation signal.

- ENTRY POINT

It may be used to select the point where to apply the excitation signal, only when the type of capture is "ADVANCED".

20.

SETUP ASSISTANCE
The Bode diagram



CNC 8060
CNC 8065

(REF: 1402)

Horizontal softkey menu

When defining a new graphic configuration and modified parameters, the system permits saving that configuration in a file. Likewise, the system allows loading a configuration that was saved previously or resetting the current configuration.

- Save the current configuration.

After pressing the "Save" softkey, the CNC shows the list of available configurations and lets you save the current configuration. The file extension must be bod.

- It loads a previously saved configuration.

After pressing the "Load" softkey, the CNC shows the list of previously saved configurations and lets you select any of the them.

- Reset or initialize the current configuration.

Pressing the "Reset" softkey of the configuration screen deletes or initializes the current configuration. There are neither variables nor parameters selected and the rest of conditions assume the values assigned by default.

- Activate/Cancel reference capture.

It may be used to activate or cancel the configuration of the reference Bode.

20.**SETUP ASSISTANCE**
The Bode diagram**FAGOR** **CNC 8060
CNC 8065**

(REF: 1402)

20.3 The circularity (roundness) test

This tool helps improve and adjust the axis reversal peak, an effect that appears when the axes reverse their moving direction. With this utility, a circle may be executed with the axes and graphically show the result. This graphic shows the difference between the actual (real) coordinate obtained from the feedback device and the theoretical coordinate calculated at each point. This difference is shown projected radially.

The same screen showing the graphics also shows the machine parameters that affect the movement reversal. These parameters may be modified while running the test, thus being possible to evaluate the response of the system to these changes and optimize the adjustment on the go.

The circularity (roundness) test diagram is an assistance tool that only shows the response of the system to the various settings (adjustments); it is up to the technician to choose the best adjustment.

20.**SETUP ASSISTANCE**
The circularity (roundness) test

CNC 8060
CNC 8065

(REF: 1402)

20.3.1 Interface description

The screen of the circularity test looks like this, with two clearly different parts. A graphics window that shows the result of the test and a data area for interacting with the system.

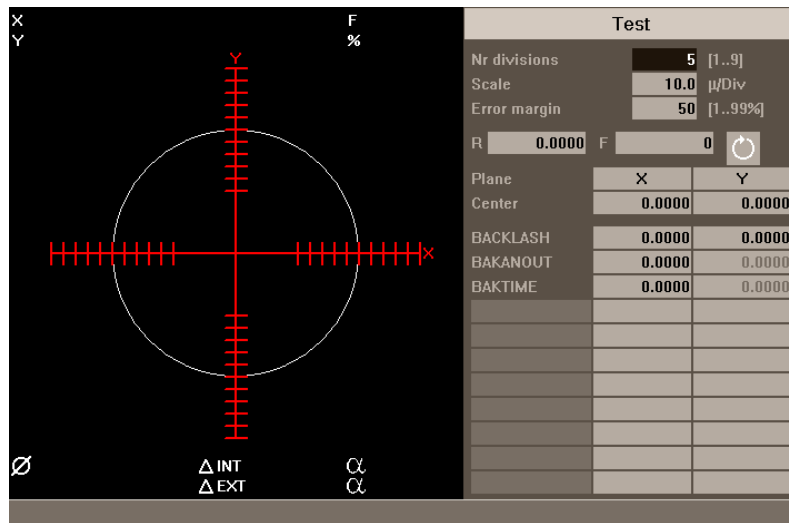

The graphics window

It is the area that shows, graphically, the result of the test. The graphic shows the two moving axes and the theoretical circle of the interpolation that will be carried out. As the test is being run, the positioning error at each point is drawn on the circle. This error is shown projected radially.

Superimposed on the graphics, it shows the following additional data that is updated by the CNC.

- The real coordinates of the axes.
- Programmed feedrate and % applied.
- Diameter of the displayed circle.
- Maximum and minimum error over the theoretical radius and angular position where it has been detected.

The data area

It is the area where the user interacts with the system. It offers a set of data for defining the graphic environment, the subroutine that will be used to generate the machine movement and the machine parameters involved in the adjustment. Selecting one of the data frames the group of parameters it belongs to.

Graphic environment data to be configured

- Number of divisions on both sides of the theoretical circle.
- Scale or value in microns of each division.
- Error margin. Percentage of the area that is occupied by the error margin (divisions area).

20.

SETUP ASSISTANCE
The circularity (roundness) test

FAGOR 

CNC 8060
CNC 8065

(REF: 1402)

Movement subroutine

The circular interpolation is carried out using a subroutine. See ["20.3.5 Define and execute the movement subroutine"](#) on page 366.

The following data is taken into consideration when executing the subroutine.

- Plane where the circle is executed.
- Circle center coordinates.
- Circle radius.
- Programmed feedrate.
- Turning direction.

Parameters to be set

To make the adjustment, it is possible to change the CNC machine parameters or the drive machine parameters involved. See ["20.3.7 Adjustment of the machine parameters involved"](#) on page 368.

It is possible to interact with up to 11 different machine parameters. Some of these parameters are always visible, but some may be defined at will. For each parameter, it shows its value on each axis of the work plane.

To see the whole list of parameters that may be defined, see section ["20.3.9 Machine parameters that may be modified"](#).

20.

SETUP ASSISTANCE
The circularity (roundness) test



CNC 8060
CNC 8065

(REF: 1402)

20.3.2 Softkey menus.

Horizontal softkey menu.

The horizontal softkey menu offers the following options.

Softkey.	Description.
Softkey "Simple".	It captures the data of a full circle.
Softkey "Continuous".	It captures data continuously.
Softkey "Stop".	It stops the data capture. This softkey is shown when data capture is running.
Softkey "Clear".	It deletes the graphic representation. It may be done while the capture is running; in that case, it goes on with the graphic representation.
Softkey "Load".	It loads a previously saved configuration.
Softkey "Save".	It saves the configuration defined.



The "Stop" softkey only stops the data capture. It does not stop the movement of the axes. To stop the movement of the axes, press the [STOP] key of the operator panel.

Vertical softkey menu.

The vertical softkey menu offers the following options.



- Softkey "Validate".

It saves the values of the machine parameters in the tables of the CNC and/or the drive accordingly.

When changing the values of the machine parameters, the changes are effective immediately. However, these changes are maintained only during the current session of the CNC; i.e. until the unit is turned off. On power-up, it assumes the values stored in the tables.



- Softkey "Initialize".

It resets the window data to its default values.

20.

SETUP ASSISTANCE

The circularity (roundness) test

FAGOR 

CNC 8060
CNC 8065

(REF: 1402)

20.3.3 Configuring and executing the circularity (roundness) test

The process consists in executing a circle with the axes of the machine and verifying it on its graphic representation. The graphic shows the difference between the actual (real) coordinate obtained from the feedback device and the theoretical coordinate calculated in that point. This difference is shown projected radially.

The interpolation of the machine axes and the point capture for the graphics are initiated separately. The data capture is handled from the softkey menu whereas the movement of the axes is controlled from the operator panel.

The adjustment process is repeated until obtaining the best adjustment of the axes. The circularity (roundness) test diagram is an assistance tool that only shows the response of the system to the various settings (adjustments); it is up to the technician to choose the best adjustment.

How to execute the circularity (roundness) test

Basically it is done as follows. Each of these points is described in more detail in the indicated chapter. The configuration used may be saved in a file for later.

- 1 Before initiating the process, certain aspects must be configured as well as the graphic environment, the circular interpolation, the values of the parameters involved, etc. A previously saved configuration may be used. See ["20.3.3 Configuring and executing the circularity \(roundness\) test"](#) on page 364.
- 2 Execute a circular interpolation of the machine axes. The axes must be moving before the data capture starts. See ["20.3.5 Define and execute the movement subroutine"](#) on page 366.
- 3 Initiate the data capture and the graphic simulation. Once the axes are moving, the data capture for the graphics may begin. While capturing data, the position error at each point is drawn on the graphics. See ["20.3.6 Data capture for the graphic"](#) on page 367.
- 4 Optimize the adjustment by changing some machine parameters of the CNC or of the drive. This makes it possible to evaluate the system response to these changes and optimize the adjustment. See ["20.3.7 Adjustment of the machine parameters involved"](#) on page 368.
- 5 Save the modified values and the configuration used. See ["20.3.8 Validate the changes and save the configuration used"](#) on page 370.

Move through the data

To enter or modify a data, it must be selected; i.e. it must have the editing focus on it. To select a data, use the [←][→][↑][↓] keys.

The data are accepted with the [ENTER] key. Before accepting a data, it is checked out and if the data is not correct, it is not accepted.

20.

SETUP ASSISTANCE
 The circularity (roundness) test



CNC 8060
CNC 8065

(REF: 1402)

20.3.4 Configure the graphic environment

This operation may be carried out before or during the test. If they are modified during the test, the screen is cleared and the graphic representation goes on.

The following graphic characteristics may be defined from the data window.

- Number of divisions on both sides of the theoretical circle.
- Scale or value in microns of each division.
- Error margin. Percentage of the area that is occupied by the error margin (divisions area).

Initialize the data

When accessing the circularity test, it assumes the values used last. Pressing the "Initialize" softkey restores the default values.

Number of divisions	5
Scale:	10 microns/division
Error margin:	50 %



Bear in mind that the softkey Initialize initializes all the data of the window, including the values of the machine parameters.

20.**SETUP ASSISTANCE**

The circularity (roundness) test

FAGOR **CNC 8060
CNC 8065**

(REF: 1402)

20.3.5 Define and execute the movement subroutine

In order to run the test, the axes of the machine must be executing a circular interpolation. The axes must be moving before initiating the point capture and they must keep moving during the whole process. To achieve this, a repetitive movement must be executed.



The movement of the axes is managed from the operator panel. The softkey menu only controls the data capture for the graphics.

Subroutine associated with the circularity test

The circular interpolation is executed with the subroutine associated with the circularity test. This subroutine is located in the folder "C:\CNC8070 \MTB \SUB \testcirc_vx.nc", where vx indicates the subroutine version and neither its name nor its location must be changed. This subroutine may be modified by the OEM to adapt it to his needs.

Some data of the subroutine are defined in this window.

- Plane where the circle is executed.
- Circle center coordinates.
- Circle radius.
- Programmed feedrate.
- Turning direction of the axes. The turning direction is given by an icon. To change the turning direction, place the focus on the icon and press [SPACE].

Execute the associated subroutine

Press the [START] key to execute the subroutine. The subroutine data cannot be modified while it is being executed. The movement must be stopped before editing any of the data.

When trying to execute the subroutine, if it is not in its pre-established location, the CNC interprets that it does not exist and it creates a predefined one.

Example of a subroutine

The following example executes a repetitive circular movement in the XY plane. In this case, the repetitive movement is carried out in an endless loop using the "GOTO" command. The movement is stopped with the [STOP] key of the operator panel.

```
%testcirc_V1
G1 G5 X0 Y0 F1000
N10:
  G2 X0 Y0 I10 J0
$GOTO N10
M29
```

20.3.6 Data capture for the graphic

Once the graphic representation has been defined and the machine axes are being interpolated, the point capture for the graphics may begin.

The point capture is initiated from the softkey menu. The point capture may be either simple, where the graph is made once (a single whole circle), or continuous where the graph is redrawn for every interpolation of the machine (after every whole circle).



When capturing points in the circularity test, they are not drawn on the graphics of the CNC.

The machine parameters may be modified while capturing points. See ["20.3.7 Adjustment of the machine parameters involved"](#) on page 368.

Simple data capture

Data capture is initiated with the "Simple" softkey. This softkey deletes the graph and starts drawing the circularity error enlarged to the defined scale. The capture ends after a whole circle or when the "Stop" softkey is pressed.

Continuous point capture

Data capture is initiated with the "Continuous" softkey. This softkey deletes the graph and starts drawing the circularity error enlarged to the defined scale. The capture ends when the "Stop" softkey is pressed.

When modifying the machine parameters, it is possible to see the new graph over the previous one or press the "Clear" key to only see the new one.

Stop the point capture

Press the "Stop" softkey to stop the data capture. This softkey stops the simple or continuous data capture at any time. Once the data capture is completed, two lines are drawn on the graph indicating the angular position of the maximum and minimum error.



This softkey only stops the data capture. It does not stop the movement of the axes. To stop the movement of the axes, press the [STOP] key of the operator panel.

Delete the graphic representation

Use the "Clear" softkey to delete the graph. This softkey deletes the graph and the data shown over it. It may be pressed at any time, even while it is being drawn.

20.

SETUP ASSISTANCE
The circularity (roundness) test

FAGOR 

CNC 8060
CNC 8065

(REF: 1402)

20.3.7 Adjustment of the machine parameters involved

The best adjustment of the backlash peak may require modifying the value of certain machine parameters. This may be done directly in this window, thus without having to go to the machine parameter table. The parameters may be modified before or during the test.

When turning the CNC on, it assumes the new values in the CNC tables and/or in the drive tables accordingly. When changing these values, the changes are effective immediately and are assumed by the CNC until the unit is turned off. Once the setup is completed, the changes must be validated so they can be effective next time the CNC is turned on.

20.

SETUP ASSISTANCE
The circularity (roundness) test

Selection of the parameters to be displayed

It is possible to interact with up to 11 different machine parameters. Some of these parameters are always visible, but some may be defined at will. However, the CNC will only admit the valid parameters for this type of adjustment. See "[20.3.9 Machine parameters that may be modified](#)" on page 371.

BACKLASH	
BAKANOUT	Additional velocity command pulse
BAKTIME	Duration of the additional velocity command pulse

When using Fagor Sercos drives, the drive parameters may also be adjusted.

In a Mechatrolink bus, access to variables and parameters of the device is only available for the Mlink-II mode with 32 bytes. The circularity test can access the parameters of the device using its identifier (hexadecimal number between P0000 and PFFFF).

How to select the parameters

The parameter setting area shows three data columns. The parameters are defined in the first column. The rest of the fields show the parameter value for each axis.

The list of valid parameters is shown when editing a parameter or pressing [SPACE]. Use the [↑][↓] keys to move through the list and [ENTER] to select one of them. Once selected, the rest of the fields show the parameter value for each axis.

To select the parameters of the drive, simply write their names.

Save the value of the parameters

The new data is assumed by the CNC until the unit is turned off. Once the setup is completed, the changes must be saved so they can be effective next time the CNC is turned on. Use the "Validate" softkey to save the data. The CNC saves the new values in the CNC tables and/or in the drive tables accordingly.

When quitting the circularity test without having saved the parameters, the CNC will show a message warning about it and will give a chance to save them.

Password-protected parameters

If the machine parameters are protected, a password will be requested when trying to modify them. If entered correctly, it stores it and it does not request it again unless the CNC is turned off. If the password is wrong, the values cannot be modified and it requests it again every time.

The test may be executed even when not knowing the access password, but the machine parameters cannot be changed. The access passwords are determined from the utilities mode.

Initialize the value of the parameters

When turning the CNC on, it assumes the new values set by the manufacturer in the CNC tables and/or in the drive tables accordingly. The values used the last time will be kept for when accessing the test again later.



CNC 8060
CNC 8065

(REF: 1402)

Pressing the "Initialize" softkey sets the values assigned to the parameters as "default values" in the tables, not those set by the manufacturer.



Bear in mind that the Initialize softkey initializes al the data of the window.

20.

SETUP ASSISTANCE

The circularity (roundness) test

FAGOR 

CNC 8060
CNC 8065

(REF: 1402)

20.3.8 Validate the changes and save the configuration used

20.

SETUP ASSISTANCE
The circularity (roundness) test

Validate the parameters

The new data is assumed by the CNC until the unit is turned off. Once the setup is completed, the changes must be saved so they can be effective next time the CNC is turned on.



Use the "Validate" softkey to save the data. The CNC saves the new values in the CNC tables and/or in the drive tables accordingly.

When quitting the circularity test without having saved the parameters, the CNC will show a message warning about it and will give a chance to save them.

Save and load the configuration

The system permits saving the current configuration into a file in ASCII format (extension "TST"). This file only contains the configuration. It contains neither the graphics nor the values of the machine parameters. When loading a configuration, the parameters assume the value they have at the time.



The configuration saving option does not update the machine parameter table. To do that, use the Validate softkey.

Save the configuration

Press the "Save" softkey to save the current configuration. Select the folder and the file name and press [ENTER]. If there is a configuration already saved with the same name, it will ask whether it is to be replaced or not.

By default, the configuration is saved in the folder "C:\CNC8070 \MTB \DATA" or in the last folder selected by the user.

Load the configuration

Press the "Load" softkey to load a previously saved configuration. Select the folder and the file name and press [ENTER].

20.3.9 Machine parameters that may be modified

General machine parameters.

Parameter	Units	Update
PRELFITI	ms	Immediate
PRELOAD	%	Immediate
TCOMPLIM	%	Immediate
TINTIME	ms	Immediate
TPROGAIN	%	Immediate

Axis machine parameter.

Parameter	Units	Update
BACKLASH	mm(inch) or degrees	Immediate
BAKANOUT	rpm	Immediate
BAKTIME	ms	Immediate
ACCEL	mm(inch)/s ² or degrees/s ²	Beginning of the next block
ACCJERK	mm(inch)/s ³ or degrees/s ³	Beginning of the next block
ACFGAIN	%	Immediate
ACFWFACTOR	ms	Immediate
DECEL	mm(inch)/s ² or degrees/s ²	Beginning of the next block
DECJERK	mm(inch)/s ³ or degrees/s ³	Beginning of the next block
FFGAIN	%	Immediate
G00FEED	mm(inch) or degrees	Beginning of the next block
INPOSW	mm(inch) or degrees	Immediate
LACC1	mm(inch)/s ² or degrees/s ²	Beginning of the next block
LACC2	mm(inch)/s ² or degrees/s ²	Beginning of the next block
LFEED	mm(inch) or degrees	Beginning of the next block
MANACFGAIN	%	Immediate
MANFFGAIN	%	Immediate
MAXVOLT	mV	Immediate
PROGAIN	1000/min	Immediate
SERVOOFF		Immediate

20.

SETUP ASSISTANCE
The circularity (roundness) test

FAGOR 

CNC 8060
CNC 8065

(REF: 1402)

20.

SETUP ASSISTANCE

The circularity (roundness) test



CNC 8060
CNC 8065

(REF: 1402)

21.1 Appearance of the DDSSetup mode

This operating mode may be used to set up the digital servo system by editing their parameters and variables; Sercos drives, or Mechatrolink servos and inverters. The DDSSetup shows the right services for this type of devices.

Interface description.

The DDSSetup screen shows the following information.

The screenshot shows a window titled 'DRIVES' with a table of active services. The table has three columns: a checkmark, ID, and DESCRIPTION. The active service is highlighted in black.

✓ DRIVE	ID	DESCRIPTION
CABEZAL S	1	VERSIÓN=v06.07 SPINDLE Feb 28 2005 MOTOR=FM7-A037-S1C0-E01 DRIVE=SI
EJE X	2	VERSIÓN=v06.08 AXIS BETA Apr 15 2005 MOTOR=FXM334 DRIVE=AXD1.15-SI
EJE Y	3	VERSIÓN=v06.05 AXIS Sep 24 2004 MOTOR=FXM32.30A.E1.000 DRIVE=AXD1.1
EJE Z	4	VERSIÓN=v06.05 AXIS Sep 24 2004 MOTOR=FXM32.20A.E1.000 DRIVE=AXD1.0
EJE W	5	VERSIÓN=v06.08 AXIS BETA Apr 6 2005 MOTOR=FXM12.40A.E1.000 DRIVE=AX

- A Title bar that shows the name of the active service.
- B Main window.
- C Command bar.

Select the services of the DDSSetup mode.









This operating mode may be displayed with several screens. Each of them corresponds to a service of the DDSSetup. The exchange between the different services is carried out with the list of services.

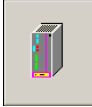

The different services overlap each other. If several services active, it is possible to switch from one to another using the [NEXT] key, if it has been set accordingly. The services are switched in a rotary manner, in such a way that when pressing on the last active service, it shows the first one. To close a screen, press [ESC].

21.1.1 Icon description (vertical softkeys)

Vertical softkey menu.

Softkey.	Description.
	Show / refresh the list of devices. Sercos and Mechatrolink. This softkey access the main screen of the DDSSetup and shows the list of devices connected to the Sercos or Mechatrolink bus. The CNC shows a short description for each device.
	Drive accessing level change. Only Sercos. This softkey is used to change the access level for drive parameters and variables. Pressing this softkey shows a window that requests the password to quit the basic level and access a new level.
	Editor for variables and parameters. Sercos and Mechatrolink. This service may be used to edit the parameters (Sercos and Mechatrolink) and the variables (Sercos) of the drive.
	Error manager. Sercos and Mechatrolink. This service shows the list of warnings, alarms and errors active at the device and, if the device allows it, the alarms log. For Sercos drives, this service may also be used to disable certain errors.
	Variable monitoring. Sercos and Mechatrolink. This service monitors the status of the variables of the devices.
	Status window. Sercos and Mechatrolink. This service monitors two types of information; the operations being carried out by the device and the status of the inputs and outputs.
	Command simulator. Only Sercos. This option may be used to configure and start up the internal command generator of the drive.
	Command line. Sercos and Mechatrolink. The command line may be used to execute the command of the drive (only Sercos), consult variables, read and write parameters, obtain information on the status of the device and insert variables in the monitoring window (only Mechatrolink).

21.

DDSETUP
 Appearance of the DDSSetup mode



CNC 8060
CNC 8065

(REF: 1402)

21.2 List of devices connected to the bus.

This service shows the list of devices connected to the bus. The information shown by this service depends on the type of bus used, Sercos or Mechatrolink.

Sercos. For each drive, the table shows the name of the axis or spindle associated with it, its identifier within the bus (node number) and a short description for it (software version, motor ID and the ID of the drive itself).

Mechatrolink. For each device (servo or inverter), the table shows the name of the axis or spindle associated with it, its identifier within the bus (node number) and a short description for it (type of device and addressing according to Mechatrolink specifications).

The command line is located at the bottom of the window. See *"21.9 Command line."* on page 386.

List of drives of a Sercos bus.

DRIVES		
DRIVE	ID	DESCRIPTION
CABEZAL S	1	VERSIÓN=v06.07 SPINDLE Feb 28 2005 MOTOR=FM7-A037-S1C0-E01 DRIVE=SI
EJE X	2	VERSIÓN=v06.08 AXIS BETA Apr 15 2005 MOTOR=FXM334 DRIVE=AXD1.15-SI
EJE Y	3	VERSIÓN=v06.05 AXIS Sep 24 2004 MOTOR=FXM32.30A.E1.000 DRIVE=AXD1.1
EJE Z	4	VERSIÓN=v06.05 AXIS Sep 24 2004 MOTOR=FXM32.20A.E1.000 DRIVE=AXD1.0
EJE W	5	VERSIÓN=v06.08 AXIS BETA Apr 6 2005 MOTOR=FXM12.40A.E1.000 DRIVE=AX



List of devices of a Mechatrolink bus.

MECHATROLINK : DEVICES		
DEVICE	ID	DESCRIPTION
X AXIS	1	ADDRESS=0x40 TYPE=Position Servo
Y AXIS	2	ADDRESS=0x41 TYPE=Position Servo
Z AXIS	3	ADDRESS=0x42 TYPE=Position Servo
S SPINDLE	4	ADDRESS=0x20 TYPE=Inverter

Horizontal softkey menu.

Saving and loading the parameters of all the servos.

With this service, it is possible to save and load the configuration of all the Sercos drives or Mechatrolink servos using a single softkey. The CNC saves the parameters of each device in a different file whose name will be the name of the axis or spindle and the extension lp (Sercos drives) or mlp (Mechatrolink servos).

Softkey.	Function.
	<p>Save the data of all the drives.</p> <p>In a Sercos bus, this softkey saves in the CNC the parameters and variables of all the drives. In a Mechatrolink bus, this softkey saves in the CNC the parameters of all the servos; it does not save the parameters of the inverters.</p>
	<p>Restore the data of all the drives.</p> <p>In a Sercos bus, this softkey restores the parameters and variables of all the drives from the files saved in the CNC. The process of restoring the parameters includes sending the command to save the parameters to flash. In a Mechatrolink bus, this softkey restores the parameters of all the servos from the files saved in the CNC; it does not restore the parameters of the inverters.</p>

If when restoring the data, a writing error occurs at a drive, the CNC will warn about it and it will give the option to either resume or abort the process. If when restoring the data, the

21.

DDSETUP

List of devices connected to the bus.

FAGOR 

CNC 8060
CNC 8065

(REF: 1402)

number of files does not match the number of elements in the bus, the CNC will warn about it and it will give the option to either resume or abort the process.



In Mechatrolink devices, not all the parameters assume the new values immediately, sometimes, the servo needs to be restarted so it assumes the new values. Refer to the documentation of the devices to know when the servos assume the new values.

Update the descriptor of the parameters and variables (only Sercos).

Softkey.	Function.
	<p>Update the descriptor of the parameters and variables. In a Sercos bus, this softkey updates file that describes the parameters and variables of the drive.</p>

21.

DDSETUP

List of devices connected to the bus.



CNC 8060
CNC 8065

(REF: 1402)

21.3 Drives accessing level (only Sercos).

The parameters, variables and commands of the drive are organized by access levels. To access each parameter, the drive must be configured at the access level required by that parameter. A password is needed to access each level.



This softkey is used to change the access level for drive parameters and variables. Pressing this softkey shows a window that requests the password to quit the basic level and access a new level.

The available access levels are the following:

- Basic level (USER)

It is the default level, it is accessed when entering the DDSSetup mode. It requires no password. The user level gives access to a group of parameters that slightly changes the operation of the drive.

- Intermediate level (OEM)

This level gives access to a large group of parameters that depend on the motor connected, they set how the electronics of the drive is adapted to that motor.

- Maximum level (FAGOR)

This level gives full access to all the variables, parameters and commands of the system.



The Fagor level gives access to a group of parameters depending on the drive's electronics and they factory set. Only technicians from Fagor Automation are granted a FAGOR access level.

21.

DDSETUP

Drives accessing level (only Sercos).

FAGOR 

CNC 8060
CNC 8065

(REF: 1402)

21.4 –Parameters and variables– service.

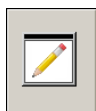

This service may be used to edit the parameters (Sercos and Mechatrolink) and the variables (Sercos) of the drive. For Mechatrolink, this service only allows editing the parameters of the servos; the parameters of the inverters cannot be accessed.

The top of the window shows the list of available axes and spindles, the groups of parameters and and, in the case of Sercos drives, the set of parameters. The command line is located at the bottom of the window. See "21.9 Command line." on page 386.

21.

DDSSSETUP
–Parameters and variables– service.

List of parameters in a Sercos drive.

PARAMÉTERS					SPINDLE S
2) DATOS INTERNOS					SET 0
MNEM...	VALUE	UNIT	RANGE	SID	NAME
%P1	0		[0..1]	F-0-52	%P1
%P111	18.77		[0.00..327.67]	S-0-119	%P111
%P112	1.775	mS	[0.000..32.767]	S-0-120	%P112
%P114	50.0	%	[10.0..1000.0]	F-0-28	%P114
%P115	100.0	%	[10.0..1000.0]	F-0-29	%P115

The "View" softkey of the horizontal menu may be used to choose displaying either the parameters and variables, only the parameters or only the variables. The table shows the following fields for each variable or parameter.

- Mnemonic of the variable or of the parameter.
- Current value at the drive.
- Units of the variable or parameter.
- Valid range of values. If the value is a string of characters, the field will show the maximum length permitted.
- Sercos identifier.
- Name of the variable or of the parameter.

When selecting a set at the top, those parameters and/or variables that have sets will display the values of that set. Also, its identifier will show the selected set (e.g. for set 4 of the variable SP2, it will show SP2.4) Parameters with a set will not be affected by the change.

List of parameters in a Mechatrolink servo.

PARAMETERS					X AXIS
A) FUNCTION SELECTION PARAMETERS					
ID	VALUE	UNIT	RANGE	NAME	
▲ P000	0255		[\$0..\$1FF1]	Function Selection Application Switches 0	
▲ P001	0140		[\$0..\$1122]	Function Selection Application Switches 1	
▲ P002	04C1		[\$0..\$4113]	Function Selection Application Switches 2	
⊙ P003	0012		[\$0..\$FF]	Function Selection Application Switches 3	
▲ P005	0000		[\$0..\$1]	Reserved (Do not change)	

The table shows the following fields for each parameter.

- Parameter identifier (hexadecimal number between P0000 and PFFFF). The symbol appearing next to the identifier indicates how the parameter assumes the new value.



The parameter may be modified at any time and it assumes the new value immediately.



The parameter may only be modified when the servo is enabled and it assumes the new value immediately.



The parameter may be modified at any time, but the Mechatrolink device must be turned of and back on.

- Current value of the parameter; if it is preceded by the "\$" sign, it will be a hexadecimal value.



CNC 8060
CNC 8065

(REF: 1402)

- Parameter units.
- Valid range of values. If the value is a string of characters, the field will show the maximum length permitted.
- Name of the parameter.



Parameter editing.

Edit the new values directly in the value field or from the command line. If the parameter accepts the new value, the table shows the change. The parameter table has a softkey to reset the parameters to their default values.

For Sercos drives, the changes are saved in the RAM memory of the drive; to save the changes permanently, use the softkey "Data" + "Flash" of the horizontal menu.



Horizontal softkey menu.

Operations with the parameter table.

Softkey.	Function.
	Print the parameter table. This softkey prints the tables on a printer or into a file (extension prn). When selecting the file option, it is saved, by default, in C:\Cnc8070\MTB\DATA.
	Look for a parameter. This softkey may be used to search for an element in the table using its identifier.

Reset (initialize) and validate the parameter table.

The "Data" softkey of the horizontal menu offers the options to reset and validate the tables.



Softkey.	Function.
	Save the servo parameters at the CNC. This softkey resets the parameters of all the tables to their default values.
	Restore the servo parameters from the CNC. This softkey validates all the parameters of the servo.



In Mechatrolink devices, not all the parameters assume the new values immediately, sometimes, the servo needs to be restarted so it assumes the new values. Refer to the documentation of the devices to know when the servos assume the new values.

Save and load the parameters of the servo.

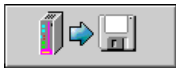
The "Data" softkey of the horizontal menu offers a series of options to make a backup copy of the tables. The CNC saves the parameters of the device in a file whose name will be the name of the axis or spindle and the extension lp (Sercos drives) or mlp (Mechatrolink servos).

Softkey.	Function.
	Save the parameters at the CNC. In a Sercos bus, this softkey saves in the CNC the parameters and variables of the drive. In a Mechatrolink bus, this softkey saves in the CNC the parameters of the servo.
	Restore the parameters from the CNC. In a Sercos bus, this softkey restores the parameters and variables of the drive from the file saved in the CNC. The process of restoring the parameters includes sending the command to save the parameters to flash. In a Mechatrolink bus, this softkey restores the parameters of the servo from the file saved in the CNC.

21.5 –Error management– service.

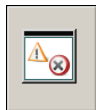

The information shown by this service depends on the type of bus used, Sercos or Mechatrolink.

Sercos. This service shows the list of errors detected by the drive and lets disable them. The errors are shown in the order they come up. Once the cause of the error has been corrected, the errors may be reset with the "Error reset" softkey of the horizontal menu.

Mechatrolink. This service shows the list of warnings, alarms and errors active at the device and, if the device allows it, the alarms log.

The top of the window shows the list of the available devices. The command line is located at the bottom of the window. See "[21.9 Command line.](#)" on page 386.

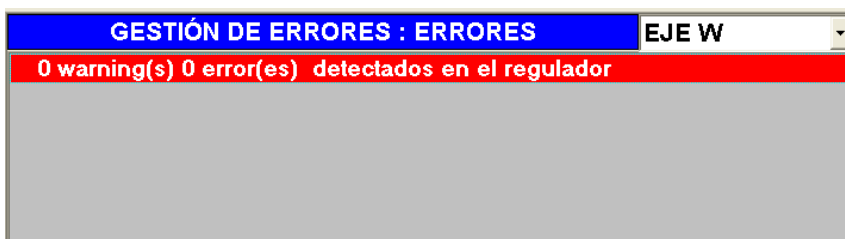

Disable the errors (only Sercos).

To disable an error of the drive, use the "Error listing" softkey of the horizontal menu. This softkey shows the whole list of possible errors. To disable the desired ones, checkmark the box on the left.

Then, press the "Send" softkey to send the list to the drive. To make the error disabling effective, execute the command DC1 (reset errors) from the command bar.

Disabling the errors requires an OEM or FAGOR access level. See "[21.3 Drives accessing level \(only Sercos\).](#)" on page 377. Even then, only resettable errors may be disabled, even if the list also shows the non-resettable errors.

Refer to the alarms log of the device (only Mechatrolink).

The horizontal softkey menu shows the list of warnings, alarms and errors active at the device and, if the device allows it, the alarms log of the device.

Softkey.	Function.
	List of active warnings, alarms and errors. This softkey shows the list of warnings, alarms and errors active at the device.
	Alarms log of the device. This softkey shows the alarms log of the device, if it offers this option.

21.

DDSSSETUP
–Error management– service.



CNC 8060
CNC 8065

(REF: 1402)

21.6 –Monitoring– service



This service monitors the parameters (Sercos and Mechatrolink) and the variables (Sercos) of any drive. The user selects the variables to be monitored.

The command line is located at the bottom of the window. See "21.9 Command line." on page 386.

List of variables of a Sercos drive.

MONITORING	
VARIABLE	VALUE
↑ GV25.5 (GV25)	
GV26.5 (GV26)	

List of variables of a Mechatrolink device.

MONITORING	
VARIABLE	VALUE
MLINK0.1 (POS)	
MLINK1.1 (MPOS)	
MLINK3.1 (APOS)	
MLINK4.1 (LPOS)	
MLINK5.1 (IPOS)	

Horizontal softkey menu.

Save, load or reset the list of variables to monitor.

Softkey.	Function.
	Save the list of variables to monitor. This softkey saves the list of variables to monitor into a file (extension dwf).
	Restore the list of variables to monitor. This softkey restores the list of variables to monitor from a file.
	Reset the list of variables to monitor. This softkey deletes all the variables defined in the window.

Begin and end the monitoring of variables.

Softkey.	Function.
	Begin monitoring.
	End monitoring.

Edit the list of variables to monitor.

The variables to be monitored are defined from the command line; edit the name of the variable and press the [INS] key. For Sercos, the softkey "Add" can also be used, it shows a window for selecting the variables or parameters to monitor.

To delete a variable or parameter from the list, select it and press the [DEL] key. The entire list may be deleted from the horizontal softkey menu.

Mechatrolink variables.

The range of available variables is MLINK0 to MLINKF and they will be associated with the devices through their name (MLINK7.X) or through the node number (MLINK7.1). If the variable does not indicate any device, the CNC associates with it the device active at the

DDSSetup. The monitoring window always shows the variables with the node number (drive ID) of the device and its abbreviation (MLINK3.5 (APOS)).

Monitoring the status of variables or parameters

Use the softkeys of the horizontal menu to start and stop the monitoring of variables. While monitoring, the window shows the following symbols next to each variable to indicate its status.



Channel occupied.



Channel occupied by DRV variables or timeout.



Reading error.

21.

DDSSSETUP
—Monitoring— service



CNC 8060
CNC 8065

(REF: 1402)

21.7 –Information– service



This service monitors two types of information, the drive status and the status of its inputs and outputs. For Mechatrolink, only the inputs and outputs of the servos can be monitored.

The top of the window shows the list of the available devices. The command line is located at the bottom of the window. See "21.9 Command line." on page 386.

Select the option to monitor on the horizontal softkey menu. In either case, an LED shows the status of each operation; green if the operation is active and black if it is inactive.

Monitor the drive status.

The "Operation status" softkey of the horizontal menu gives access to this option.

This screen monitors the status of the operation being carried out at the drive. The drive whose operations are to be monitored is selected at the top of the window. There is a led for each operation and it shows the status of the operation at the drive; green if the operation is active and black if it is inactive.

Sercos drive status.

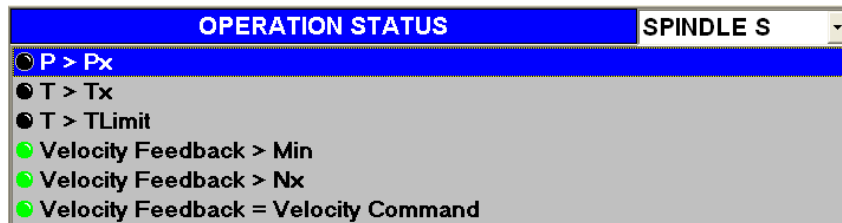

Status of a Mechatrolink device.

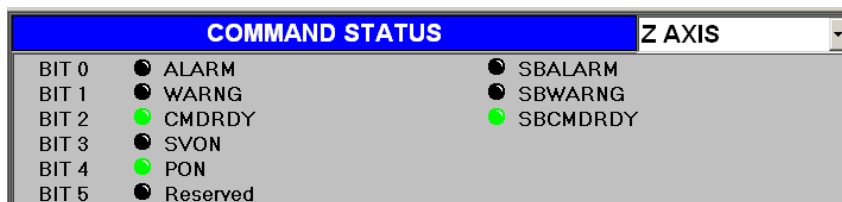

Monitor the status of the inputs and outputs.

The "Digital I/O" softkey of the horizontal menu gives access to this option.

This screen monitors the status of the digital inputs and outputs of the drive. The drive whose digital I/O's are to be monitored is selected at the top of the window. There is a led for each digital input and output of the drive showing the status of the operation at the drive; green if the operation is active and black if it is inactive.

Status of the inputs and outputs of a Sercos drive.

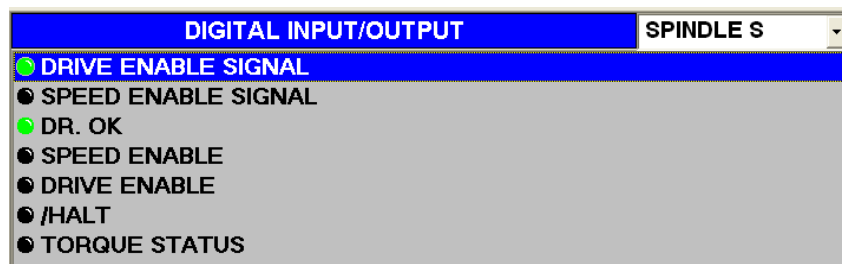

Types of inputs and outputs of a Sercos drive.

The inputs and outputs may be grouped as follows.

- Inputs and outputs that cannot be assigned. These inputs and outputs indicate the status of the drive's control signals.

Speed enable	Drive enable	Error Reset
LSC Status	DR. OK	PROG. OK
Master Speed Enable	Master Drive Enable	Master Halt
Torque Status		

- Inputs and outputs that may be assigned. Variables and/or parameters of the drive may be associated with inputs and outputs (analog and digital).

Those digital outputs that have not been associated with any parameter or variable may be forced to become active or inactive using the button on the left of their led.

21.

DDSETUP
—Information— service



CNC 8060
CNC 8065

(REF: 1402)

21.8 Command generator (only Sercos).



This option may be used to configure and start up the internal command generator of the drive. In the configuration, it is possible to establish the shape of the signal, its amplitude, period, etc.

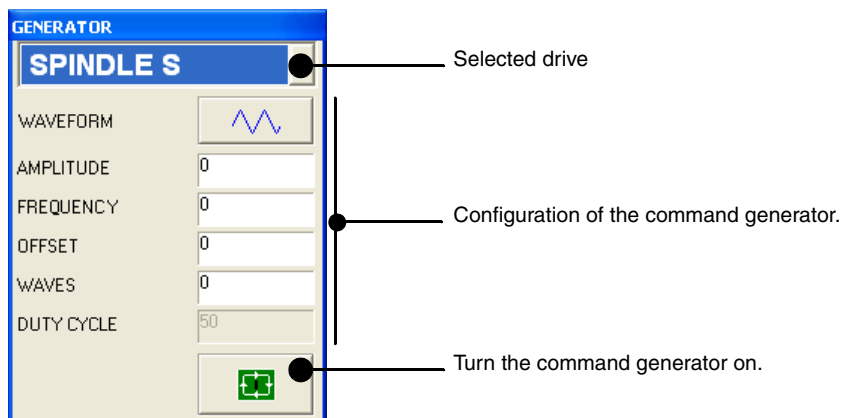

The fields to be configured at the generator are:

- Waveform. To select the type of signal to be generated with the drive (sinusoidal or square).
- Amplitude Signal amplitude.
- Frequency Signal frequency.
- Offset Signal offset.
- Waves Number of waves to generate. When set to 0 (zero), the waves are generated continuously, without interruption.
- Duty Cycle Percentage of the wave at 1/0 (only on squarewaves).

The internal command generator is turned on and off using the lower buttons.



It turns the command generator on.



It turns the command generator off.

21.

DDSSSETUP
Command generator (only Sercos).

21.9 Command line.



The command line is located at the bottom of all the services of the DDSSetup. The command line may be used to consult variables, read and write parameters, obtain information on the status of the device and insert variables in the monitoring window.

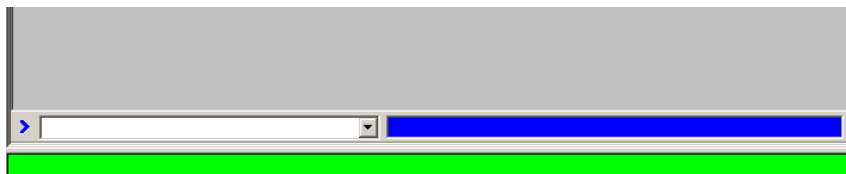

21.

DDSETUP
Command line.

Operations with a Sercos device.

- Consult and modify the variables of the drive. To read a variable, edit its name and press [ENTER]. To write a variable, assign a value to it and press [ENTER].

Read-only variables may be consulted (those with the "R" indicator on the attributes column). Read-write variables may be consulted and/or edited (those with the "RW" indicator on the attributes column). See "21.4 –Parameters and variables– service." on page 378.

Variables may be identified using their mnemonic or their Sercos identifier. Refer to the drive's manual to know the list of available variables.

- PV210 Consulting the PV210 variable.
- S36 Consulting the variable SV1 (Sercos ID = 36).
- RV9 = 23 It assigns the value of 23 to the variable RV9.
- S36 = 100 It assigns the value of 100 to variable S36 (Sercos ID = 36).

If not indicated otherwise, the DDSSetup accesses the variables of the drive selected in the service. To access those of a particular drive, select it in the service or add a suffix with the axis name to the mnemonic (or Sercos ID).

- PV210.Y It consults the variable PV210 of the Y axis drive.
- S36.S Consulting variable (Sercos ID = 16) of the spindle drive.

- Execute commands of the drive.

The drop list offers the following commands. To execute one of them, select it from the list and press [ENTER].

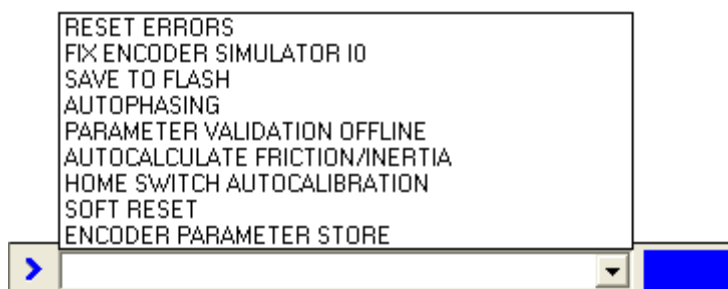

Operations with a Mechatrolink device.

- Consult variables. Edit the name of the variable and press [ENTER].

The range of available variables is MLINK0 to MLINKF and they will be associated with the devices through their name (MLINK7.X) or through the node number (MLINK7.1). If the variable does not indicate any device, the CNC associates with it the device active at the DDSSetup.



CNC 8060
CNC 8065

(REF: 1402)

- Read and write parameters. To read a parameter, edit its name and press [ENTER]. To write a parameter, assign a value to it and press [ENTER].

P102 Read parameter P102.

P102 = 800 Write the value of 800 in parameter P102.

From the command line, it is possible to access any parameter of the device using its identifier (hexadecimal number between P0000 and PFFFF).

- Obtain information on device status. Write the name of the command and press [ENTER].

MSTATUS Device status.

MSUBSTAT Device substatus.

MALARM Warning or error code reported by the device.

MIOMON Status of the device inputs and outputs.

- Insert variables in the monitoring window Access the monitoring service, edit the name of the variable and press [ENTER].

21.

DDSETUP
Command line.



CNC 8060
CNC 8065

(REF: 1402)

21.10 File for setting the parameters of Mechatrolink servos.

To communicate with the servos, the DDSSetup uses the parameter description defined in the file Sigmall.dsc (in the folder C:\...\Fagor\Drive). The DDSSetup only shows the groups and parameters defined in this file. Here is a description of the file format so a user can change it to adapt it to his devices. The properties of the parameters described in the file must be coherent with the properties of the same parameters at the device.

21.

DDSETUP
File for setting the parameters of Mechatrolink servos.

Structure of the parameters describing file (descriptor).

The header goes at the beginning of the file, defined between the labels [INFO] and [\INFO]. The file must have a header and the header must not be changed.

After the header come the parameter groups, each one defined between the labels [GROUP] and [\GROUP]. The parameters are defined inside each group, each parameter must be between the labels [P] and [\P]. The format of the groups is:

```
[GROUP=<text>]
[P<valor>]
  Size=<text>
  Type=<text>
  Default=<value>
  Range=[<value>,<value>]
  Name=<text>
  Units=<text>
  Application=<text>
[\P<valor>]
. . .
[\GROUP]
```

Here is an example of the description of a parameter group.

```
[GROUP=Position Related Parameters]
[P200]
  Type=Hex
  Default=0100
  Range=[0000,1239]
  Name=Position Control References Selection Switches
  Application=Offline
[\P200]
[P804]
  Size=4 byte
  Type=Signed
  Default=819191808
  Range=[-1073741823,1073741823]
  Units=reference unit
  Name=Forward Software Limit
[\P804]
[\GROUP]
```

The meanings of the labels are:

Label.	Description.
[GROUP]	First label of the group description and text associated with the group that will be shown by the DDSSetup.
[\GROUP]	Last label of the group description.
[P]	The first label of the description of the parameter and parameter identifier (between 000 and FFF).
[\P]	The last label of the description of the parameter and parameter identifier. The parameter identifier must be the same as that of the first label.



CNC 8060
CNC 8065

(REF: 1402)

The fields that define each parameter are the following.

Field.	Description.
Size	Size of the parameter data (2 byte / 4 byte). Optional field; if not defined, value "2 byte".
Type	Type of parameter values (Unsigned/Signed/Hex). The type conditions the editing and display of the parameter values. Type = Unsigned; Integer value without sign. Type = Signed; Integer value with sign. Type = Hex; Hexadecimal value. Optional field; if not defined, value "Unsigned".
Default	Default value of the parameter. Optional field; if not defined, value 0 (zero).
Range	Range of parameter values; minimum and maximum. Optional field; if not defined, the range will be 0 to FFFFFFFF.
Name	Name associated with the parameter. Optional field.
Units	Parameter units. Optional field.
Application	How does the parameter assume the value changes (Online/OnlineDEN/Offline)? Application=Online; The parameter may be modified at any time and it assumes the new value immediately. Application=OnlineDEN; The parameter may be modified when DEN=1 and it assumes the new value immediately. Application=Offline; The parameter may be modified at any time and it assumes the new value after turning the device off and back on. Optional field; if not defined, value "Online".

21.

DDSETUP

File for setting the parameters of Mechatrolink servos.



CNC 8060
CNC 8065

(REF: 1402)

21.

DDSETUP

File for setting the parameters of Mechatrolink servos.



CNC 8060
CNC 8065

(REF: 1402)

The diagnosis is a testing and displaying tool; it cannot be used to modify the displayed values. This operating mode may be used to test the hardware and software of the PC that the CNC is based upon.

- System information.
- Information about the modules that make up the CNC software.
- Information about the elements connected to the CNC through the CAN bus, Sercos or Mechatrolink.

22.1 Appearance of the diagnosis mode.

The diagnosis screen shows the following information.

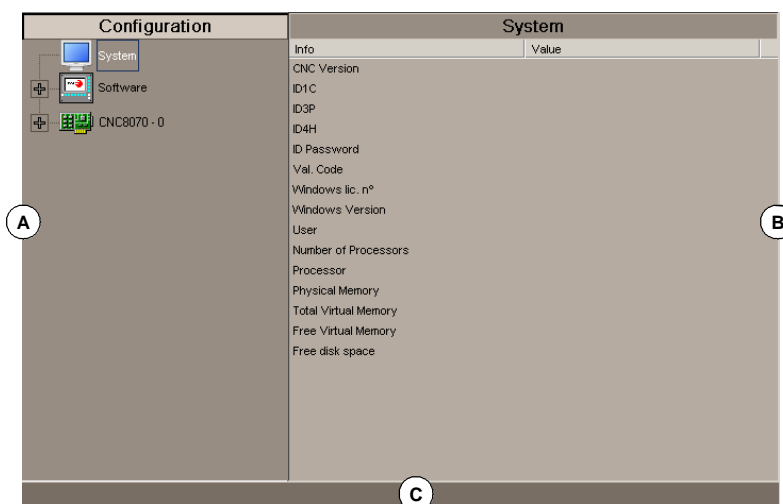

A CNC hardware and software configuration.

System diagnosis: Information on the system elements; CNC version, user name, microprocessor(s) used, status of the various system memories, etc.

Software diagnosis: Information about the modules that make up the CNC software and the software options installed.



Hardware diagnosis: Information about the elements connected to the CNC through the Can bus, Sercos (drives, input/output cards, etc.) and Mechatrolink (servos and inverters).

B Diagnosis of the selected element.



C CNC messages.

22.1.1 Softkey menus.

Horizontal softkey menu.

Softkey.	Description.
	Generate the reportfagor.zip file with all the relevant information for proper error diagnosis and, if necessary, the end user can send it to Fagor Automation.
	View the history of errors and warnings issued by the CNC.
	Access particular utilities of the operative system and other applications.

Vertical softkey menu.

Softkey.	Description.
	Update (refresh) the data of the diagnosis window.
	Print the configuration in the pre-determined printer or save it as a file (prn format) at the CNC.

22.

DIAGNOSIS

Appearance of the diagnosis mode.



CNC 8060
CNC 8065

(REF: 1402)

22.2 Configuration diagnosis

22.2.1 System diagnosis

When selecting this configuration element, the diagnosis window shows the list of the system elements and their values.

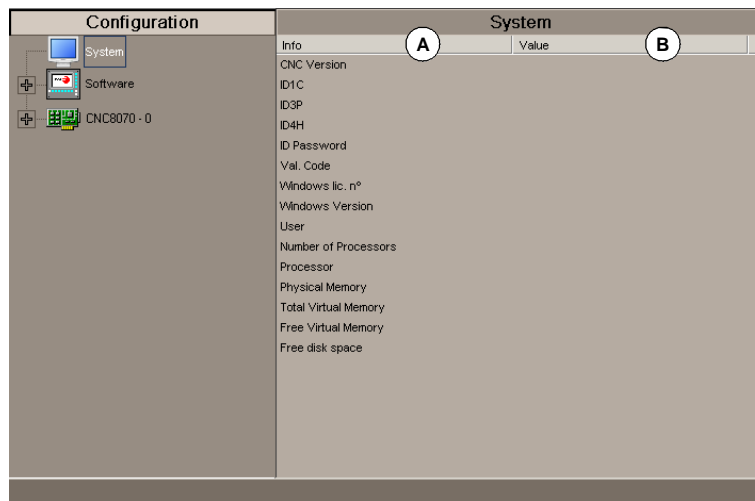

A System elements.

B Element values.

22.

DIAGNOSIS
Configuration diagnosis

22.2.2 Software diagnosis

This option may be used to analyze the modules that make up the CNC software and the software options installed.

Module information

When selecting this configuration element, the diagnosis window shows the list of the modules that make up the CNC software.

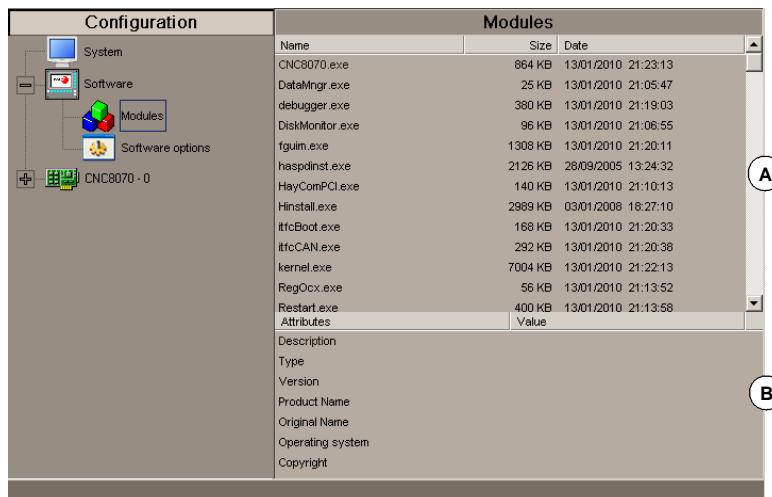

A Modules listing.

B Detailed information of the selected module.

It shows the size of each module (in bytes) and the date it was created. When selecting a module from the list, the bottom of the screen shows more detailed information.

Software options

When selecting this element of the configuration, the diagnosis window shows the software options currently installed.

It also shows the horizontal softkey "Validation code" for entering the resulting validation code according to the hardware ID of the unit and the desired options.



CNC 8060
CNC 8065

(REF: 1402)

22.2.3 Hardware diagnosis. Bus CAN, Sercos and Mechatrolink.

When selecting this element of the configuration, the diagnosis window shows the software identification of the CNC's communications board (version, boot, checksum) and the type of buses connected to it. Likewise, it monitors the different voltage and temperature alarms.

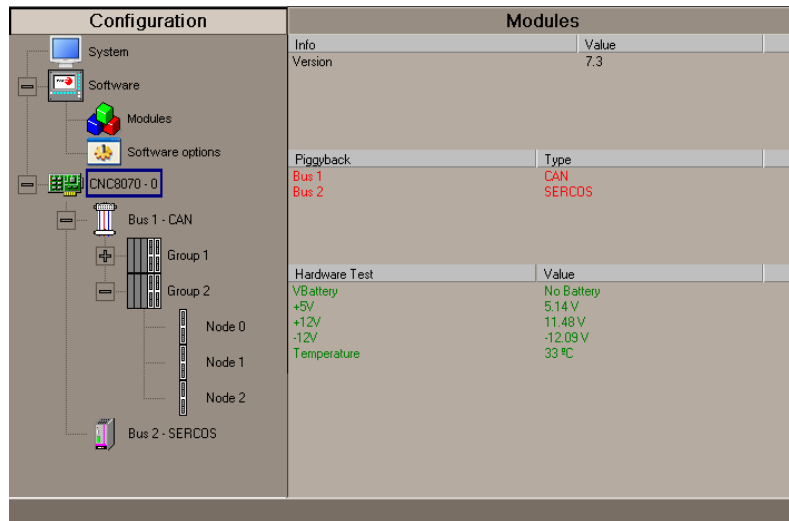

Sercos bus configuration

- Listing of nodes and drive associated with each one of them.
For each drive, it indicates its software version, type of drive and the motor connected to it.

Can bus configuration

- Resources connected and their status.
- Groups connected and number of nodes that make up each group (detected and active).



Detailed information of the selected group.

- Group resources and their status.
- Information about the nodes that make up the group.

Detailed information of the selected node.

- Software version, boot and checksum of the code.
- Node status.
- Resources of each module.

The symbol next to the node indicates its status and its possible association.

-  Active.
-  Active, but in error.
-  Inactive.

Mechatrolink bus configuration.

Bus diagnosis.

When selecting the Mechatrolink bus in the configuration window, the diagnosis window shows the bus configuration and the list of devices connected to it (servos and inverters). For each device, it indicates its node number (Drive ID), its internal address according to Mechatrolink specifications, the axis or spindle it is associated with and the type of device (position servo, velocity servo or inverter).

Device diagnosis.

When selecting a device of the bus in the configuration window, the diagnosis window shows the following information.

- General information. For each device, it indicates its node number (Drive ID), its internal address according to Mechatrolink specifications, the axis or spindle it is associated with and the type of device (position servo, velocity servo or inverter).
- Resources associated with the device.
- Information on the alarms active at the device.
- Information on the processes active at the device.

Process.	Meaning.
Phase.	Communication phase.
I/O.	Status of the device I/O (only servos).
Command.	Command active at the drive and status of its execution.
Subcommand.	Subcommand active at the drive and status of its execution.
Communication errors.	Information on the communication errors of the device.

22.

DIAGNOSIS
Configuration diagnosis



CNC 8060
CNC 8065

(REF: 1402)

22.3 Sercos diagnosis

General information about the bus

General purpose, it shows the following information about the Sercos bus.

Field.	Meaning.
Version	SERCON chip version.
Loop time	Time between two synchronization messages (MST). It is the same as general parameter LOOPTIME.
T2	Time from the MST until the CNC starts sending the telegram with the position commands (MDT).
T3	Time from the MST until the drives have the position commands.
T4	Time from the MST when the drives read the feedback values.
TL	Time from the MST until the RT IT takes place at the CNC.
Distortion errors	Distortion error counter at the CNC.
Ring errors	Sercos ring error counter.
Phase	Current Sercos phase.
Phase status	Phase status (0 = OK).
Logic ID and name	Name and driveID (number of the rotary switch) of the Sercos axes.

General information about the bus

It shows the following information for each drive.

General information

Field.	Meaning.
T1	Time from the MST until the drive starts sending its telegram (AT).
Control word	Contents of the drive's control word.
Status word	Contents of the drive's status word.
Name	Name of the Sercos axis.

Error information

Field.	Meaning.
"Reset Hard" counter	Number of times that the drive has been reset.
Distortion errors	Counter of distortion errors detected at the drive.
AT errors	Counters of AT reception errors of each drive.

Information on the last operation carried out by the service channel

Field.	Meaning.
ID	Processed Sercos ID.
Element	Processed data (Name, Units, min/max Value, Status, Value, Attributes).
Process	Operation carried out (Read, Write).
Command status	In processes with commands, it indicates its status.
Error code	Operation error code (0 = OK).

22.

DIAGNOSIS
Sercos diagnosis

FAGOR 

CNC 8060
CNC 8065

(REF: 1402)

22.4 Save the CAN configuration for the start-up test.

Saving a CAN configuration to a file serves to check the CAN configuration is correct when starting the system up. The CAN configuration must only be saved to a file after having verified that it is correct.

Save the CAN configuration.

When the CAN bus level is selected, it shows the "Save" softkey that may be used to save the current CAN configuration. The configuration is saved in the file C:\Cnc8070\mtb\data\canData.tab.

This file contains the number of groups present in the bus, the number of modules, the number of inputs and outputs, etc.

Verify the CAN configuration during power-up.

To verify the configuration, the information must be previously saved to the file *canData.tab*.

During the power-up process, the data saved in the *canData.tab* file is compared with the data read during power-up. If when comparing the data, they are not the same, the corresponding error message is issued.

"The CAN configuration is not the same as the one saved in the file"

Once the error is detected, it will keep coming up even after a reset. There two ways to correct the error:

- Power up the CNC again with the original CAN configuration; the one saved in the *canData.tab* file
- Save the new CAN configuration. The CAN configuration must only be saved to a file after having verified that it is correct.

At a CNC with a write-protected (read-only) disk, when it is started up in user mode, the MTB folder is protected and the changes made to it are temporary until the unit is turned off. In order for the CAN configuration file not to be eliminated when turning the unit off, it must be started up in setup mode and then save the CAN configuration.

22.

DIAGNOSIS
Save the CAN configuration for the start-up test.



CNC 8060
CNC 8065

(REF: 1402)

22.5 Report generation

Automatic reports generated when accessing the diagnosis mode

Every time when accessing the diagnosis mode, the CNC generates the following reports. These reports are saved in the folder C:\CNC8070 \Diagnosis\Blackbox.

SystemInfo.txt	Validation code.
SercosInfo.txt	Version of drives, motors and feedback.

Generate a report with the system configuration

A report with all the information offered by the diagnosis mode may be obtained from any section of the diagnosis mode. This produces a document with all the information about the FAGOR system installed on a machine such as the software version, status of the remote modules, installed drives and motors, etc.



To print the information, use the "Print" softkey. Pressing this softkey, the CNC will request the data it must include on the report. The CNC can create a report with the data shown on the screen or with the whole configuration of the system.

This information may be printed or saved to a file. When printing to a file, it is possible to select the name and location of the file.

Generate the warranty registration report.

The CNC can generate a template so the end user can send to Fagor the documentation with the serial numbers of all the elements in order to obtain the corresponding warranty. This template, one printed out, contains the fields that the user must fill out and then send it to Fagor Automation.



To print the warranty registration form, use the "Print" softkey. After pressing this softkey, select "warranty registration report".

The report may be printed or saved to a file. When printing to a file, it is possible to select the name and location of the file.

22.

DIAGNOSIS
Report generation

FAGOR 

CNC 8060
CNC 8065

(REF: 1402)

22.6 View the history of errors and warnings issued by the CNC.



The softkey menu shows a window with the history of errors and warnings issued by the CNC. Pressing this softkey displays the following window.

Error LOG				
E6002		The PLC program is not running.	320-558	25/01/10 9:58:08
E6002		The PLC program is not running.	320-558	25/01/10 9:58:08
E	A	B	C	D
		Checksum error in PLC #1 sta.	359	25/01/10 9:58:06

- A Error or warning number.
- B Number of the channel where the error or warning occurred; this cell does not show any value when it is a system error or system warning.
- C Text of the error or warning.
- D Internal code of the error or warning.
- E Date when the error or warning occurred.

22.7 Generating the Fagor file for error diagnosis.



The softkey menu offers the possibility to generate the reportfagor.zip file with all the relevant information for proper error diagnosis and, if necessary, the end user can send it to Fagor Automation.

After pressing this softkey, the CNC creates the reportfagor.zip file and saves it in the "C:\Cnc8070\Diagnosis" folder. When pressing this softkey, the CNC also generates the following files in the "C:\Cnc8070\Users\Reports" folder and includes them in the reportfagor.zip file.

Diagcnc.txt	CNC diagnosis report.
Hardware.txt	Hardware configuration report.
Times.txt	Time statistics report.

22.8 Access particular utilities of the operative system and other applications.



When the "User" mode to access Windows is not available, this softkey may be used to access certain utilities of the operative system (Windows date and time, Task Manager, etc.) from the CNC itself.

The utilities and applications that may be accessed with this softkey are preset by the OEM (file C:\...\MTB\MMC\Config\Apps.ini).



CNC 8060
CNC 8065

(REF: 1402)



CNC 8060
CNC 8065

(REF: 1402)

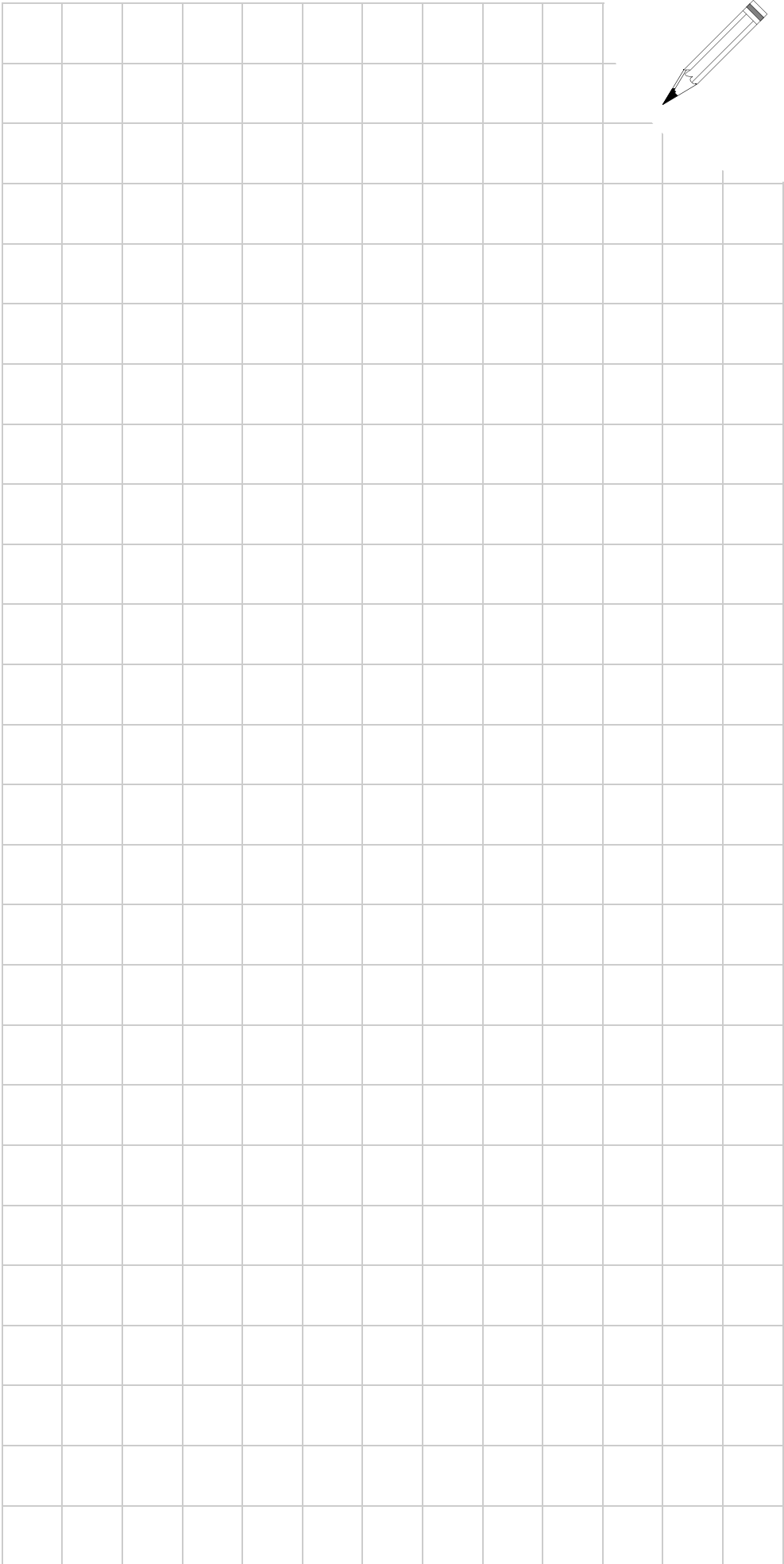

CNC 8060
CNC 8065

(REF: 1402)



CNC 8060
CNC 8065

(REF: 1402)